

## TCS SERIES ENGINEERING INFORMATION

**The TCS-152 is a two-way loudspeaker enclosure available in either switchable active/passive or digitally self-powered formats, and designed for use in a wide range of fixed installations.**

It consists of a 15" reflex-loaded low frequency driver and a 1.4" high frequency compression driver with a choice of factory-supplied HF horn patterns on a rotatable Dendritic waveguide in an optimally tuned double trapezoidal enclosure. These high grade components are matched with an internal passive crossover, which can be by-passed for bi-amped operation if required.

The cabinet is constructed from 15mm (5/8") birch plywood, screwed and glued together for maximum rigidity, with a powder-coated perforated steel mesh grille backed with reticulated foam. The double trapezoidal cabinet shape conveniently allows the TCS-152 to be tight packed with other TCS series enclosures. Multiple rigging points, supported by internal steel flying strips, are provided on the top, bottom, sides and rear of the cabinet to enable it to be suspended and angled in permanent installations using M10 shoulder eyebolts. The enclosure is also fitted with internal rigging points for use with Turbosound and OmniMount™ wall and ceiling brackets.

A Neutrik® Speakon NL4 speaker connector is located on the rear panel providing input connections, while a 4-way barrier strip provides input and loop-through connections to additional TCS cabinets.

The TCS-152 is finished as standard in durable black or white semi-matt textured paint; custom colour options are also available for decor matching. An IP54 weather-resistant version is optionally available (non-powered only) with stainless steel grille, black or white weather-proof paint finish and captive cable gland, enabling use outdoors and in humid conditions.

**The TCS-152DP is a 2 x 800 watt digitally self-powered option** featuring a new generation of innovative Class D power amplifier modules, utilising revolutionary 96kHz DSP technology to give operating efficiency in excess of 90%. The fully integrated amplifier and control electronics module incorporates high performance limiters set to optimise the continuous power and excursion thresholds, and is fully networkable to allow remote control and monitoring of critical performance parameters. The switch-mode power supply is auto-sensing over a range from 100 volts to 240 volts.



### FEATURES

- HF dispersion options:**  
60°x40° | 90°x60° | 90°x40°
- Compact enclosure**
- Dendritic waveguide**
- Rotatable HF pattern**
- Self-powered option**
- Double trapezoidal shape**
- Multiple rigging points**
- Passive crossover**
- Switchable active/passive**
- Custom colour option**
- IP54 weather-resist option**

### APPLICATIONS

- Fixed installations**
- Pubs, clubs and bars**
- Music venues**
- Houses of Worship**
- Stadia and arenas**
- Public address**
- Voice alarm**

<b>DIMENSIONS (HxWxD)</b>	838mm x 469mm x 433mm (33" x 18.5" x 17")		
<b>NET WEIGHT</b>	TCS-152: 36kg (79.2lbs), TCS-152DP: 38kg (83.6lbs)		
<b>COMPONENTS</b>	1 x 15" (381mm) LF driver, 1 x 1.4" (35mm) HF driver		
<b>FREQUENCY RESPONSE</b>	65Hz - 20kHz $\pm$ 3dB; 45Hz - 20kHz $\pm$ 10dB		
<b>NOMINAL DISPERSION</b>	60°H x 40°V (TCS-152/64), 90°H x 60°V (TCS-152/96), 90°H x 40°V (TCS-152/94) @ -6dB points All horn patterns are rotatable within the cabinet		
<b>POWER HANDLING</b>	HF: 100 watts r.m.s., 200 watts program; LF: 500 watts r.m.s., 1000 watts program Passive: 500 watts r.m.s., 1000 watts program		
<b>SENSITIVITY</b>	HF: 104dB, LF: 95dB, 1 watt @ 1 metre; Passive: 95dB, 1 watt @ 1 metre		
<b>MAXIMUM SPL</b>	HF: 124dB continuous, 130dB peak; LF: 122dB continuous, 128dB peak Passive: 122dB continuous, 128dB peak		
<b>NOMINAL IMPEDANCE</b>	HF: 8 ohms, LF: 8 ohms; Passive: 8 ohms		
<b>CROSSOVER</b>	Internal passive network at 1.2kHz; 24dB/octave high-pass, 24dB/octave low-pass		
<b>CONSTRUCTION</b>	15mm (5/8") birch plywood. Finished in black or optional white semi-matt textured paint.		
<b>GRILLE</b>	Powder-coated perforated steel with foam backing		
<b>CONNECTORS</b>	(1) Neutrik® Speakon NL4MP, wired pin1+: positive, pin 1-: negative, pins 2+ and 2- N/C (passive); pin1+: LF positive, pin1-: LF negative, pin2+: HF positive, pin2-: HF negative (1) 4-way barrier strip connector		
<b>AMPLIFIER (TCS-152DP)</b>	<b>TYPE:</b>	Class D	
	<b>CONNECTORS:</b>	1 x female XLR (input), 1 x male XLR (link) 2 x RJ45 network, 1 x Powercon mains	
	<b>INDICATORS:</b>	Power (blue), signal (green), limit (red)	
	<b>POWER OUTPUT:</b>	2 x 800 watts continuous @ 8 ohms (1kHz, 0.01% THD)	
	<b>MAX INPUT:</b>	+10dB for rated output	
	<b>BANDWIDTH:</b>	20Hz - 20kHz $\pm$ 0.5dB	
	<b>POWER REQUIREMENTS:</b>	100V to 240V AC @ 50/60Hz, auto switching	
<b>OPTIONS</b>	Optional finishes: white and custom colours IP54 weather-resistance: stainless steel grille, black or white weatherproof paint finish, captive cable with cable gland (non-powered only)		
<b>FLYING HARDWARE</b>	(9) M10 internal rigging points with internal steel strips for M10 eyebolts (4) M10 internal rigging points for WB-55 and CB-55 brackets (4) M8 internal rigging points for OmniMount™ 120 series brackets		
<b>SPARES AND ACCESSORIES</b>	LS1529	LS-1529	15" (381mm) LF loudspeaker
	05B3150	RC-1529	Recone kit
	04A9275/2	CD-213.2	1.4" (35mm) HF compression driver
	05B9275	RD-213.2	Replacement diaphragm
	10G1100	PX-TCS122/152	Passive crossover
	16F915	TCS-15XDP	Amplifier module
	07B392	EB-10/18	M10x18mm eyebolt
	07B820	WB-55	Wall bracket
	07B840	CB-55	Ceiling bracket

**TCS SERIES ENGINEERING INFORMATION**

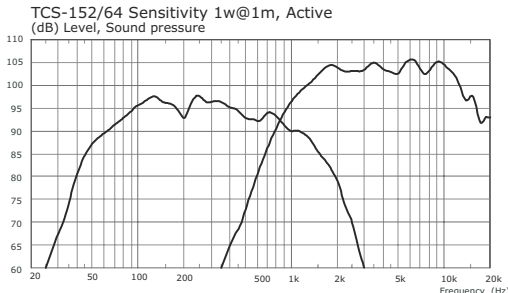
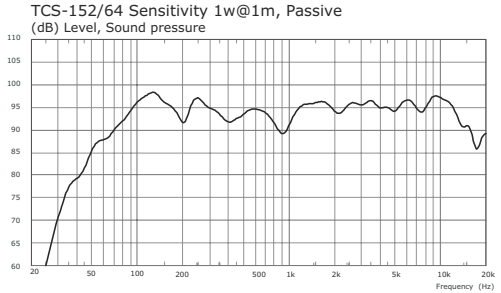

**FREQUENCY RESPONSE**

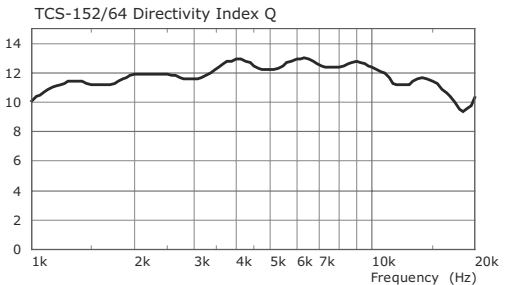
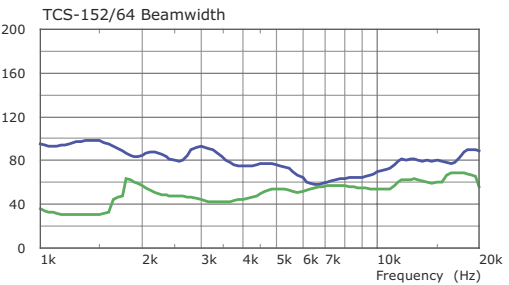

**BEAMWIDTH AND DIRECTIVITY**

TCS-152/64 Horizontal Mapping

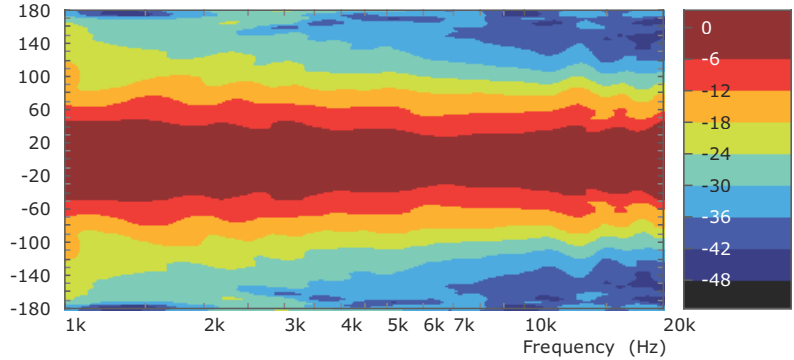

**CONTOUR MAPS**

TCS-152/64 Vertical Mapping

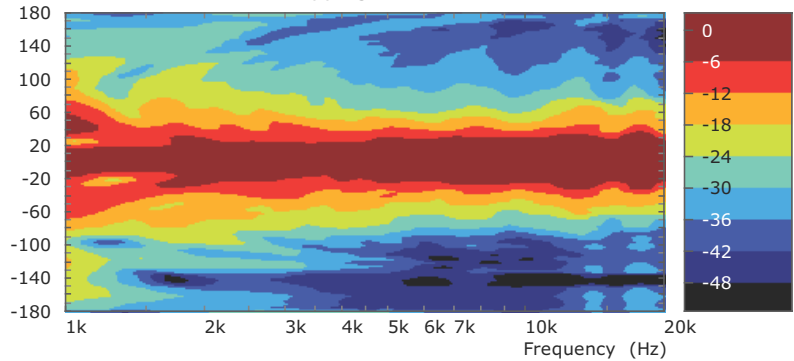

Measured 1w/1m full space 1/3 Octave Smoothed, shown active with LR24 x-over

**NOTES ON MEASUREMENT CONDITIONS**

**FREQUENCY RESPONSE**

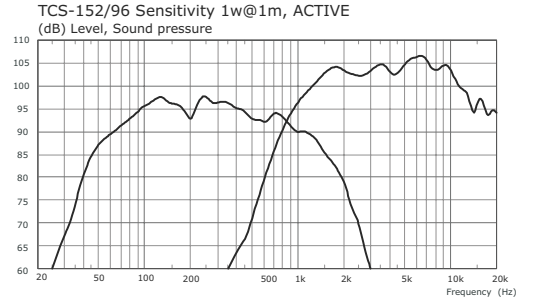
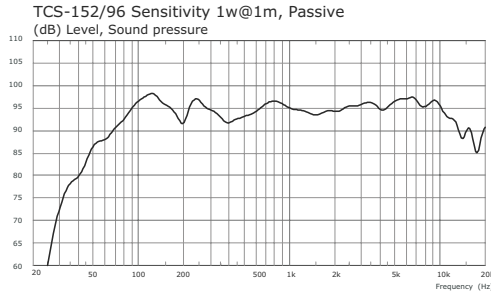

**BEAMWIDTH AND DIRECTIVITY**

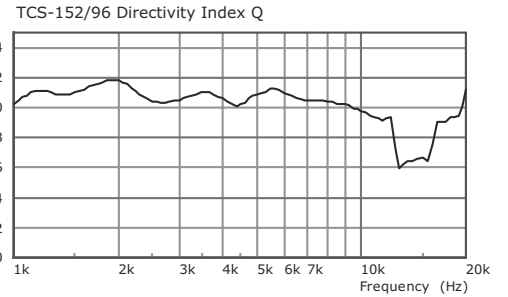
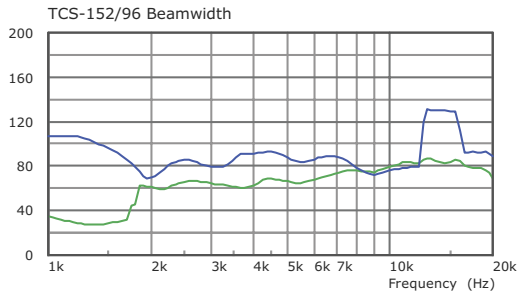

**CONTOUR MAPS**

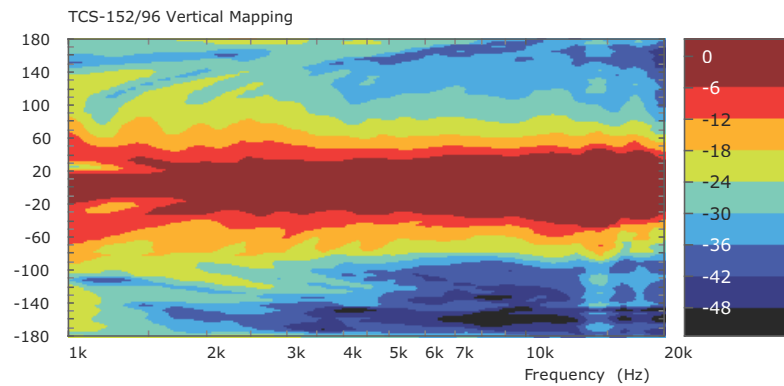
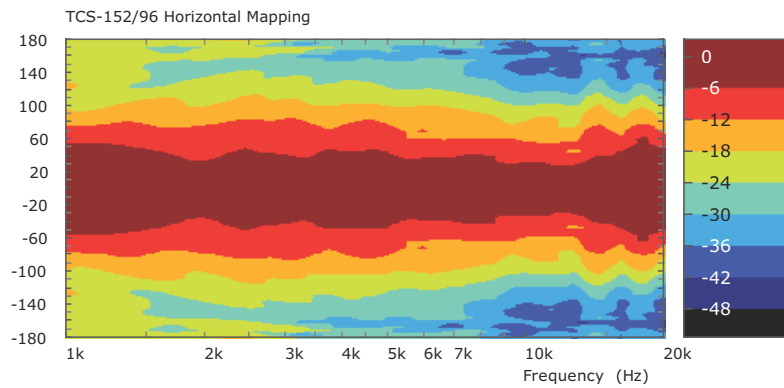

**NOTES ON MEASUREMENT CONDITIONS**

Measured 1w/1m full space 1/3 Octave Smoothed, shown active with LR24 x-over

**TCS SERIES ENGINEERING INFORMATION**

**FREQUENCY RESPONSE**

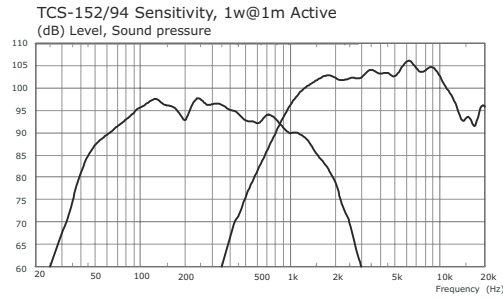
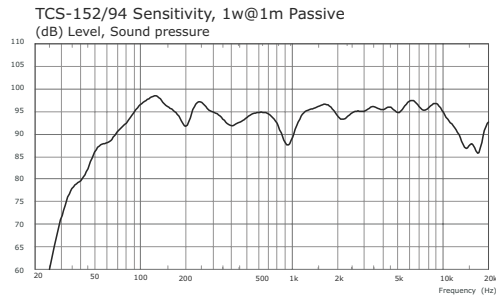

**BEAMWIDTH AND DIRECTIVITY**

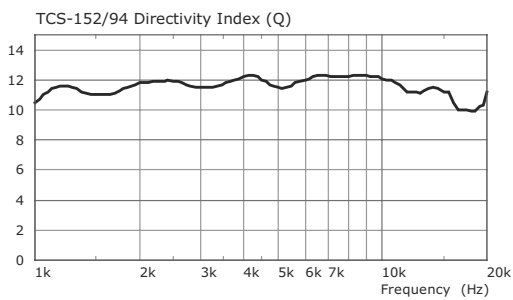
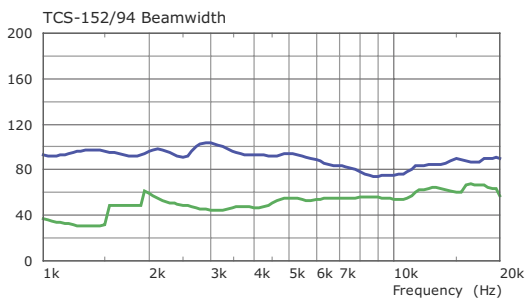

**CONTOUR MAPS**

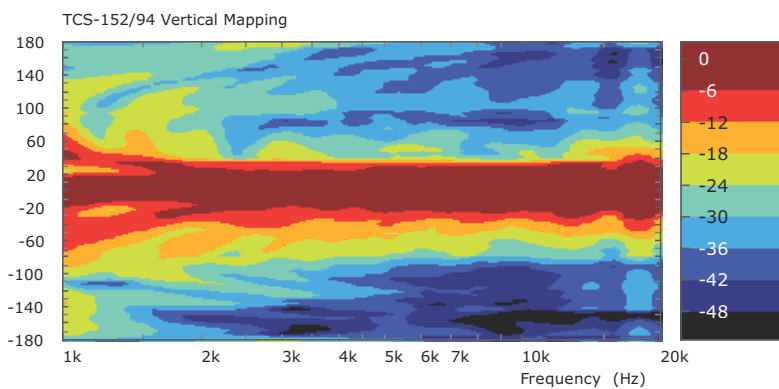
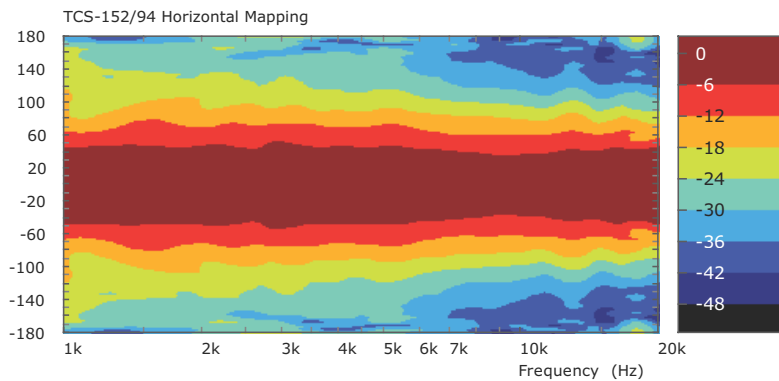

Measured 1w/1m full space 1/3 Octave Smoothed, shown active with LR24 x-over

**NOTES ON MEASUREMENT CONDITIONS**

**INSTALLATION  
HARDWARE**

Cabinets can be arrayed in a vertical column using ICC-2V inter-cabinet coupling plates attached to the internal rigging points on the cabinet to lock them together, and suspended using M10 eyebolts. The column can be tilted using the rear pull-back point on the lower cabinet. The top cabinet can be inverted as shown here in order to make use of coupling between the HF horns.

A three-wide horizontal cluster can be assembled using ICC-3H inter-cabinet couplers together with FP-1 flyplates, which lock the cabinets together in a single tight-packed block. Rigging the cabinets in a tight-packed horizontal format with TCS bass cabinets is achieved using ICC-3H, ICC-4H and ICC-5H cabinet couplers, together with FP-1 and FP-2 flyplates.

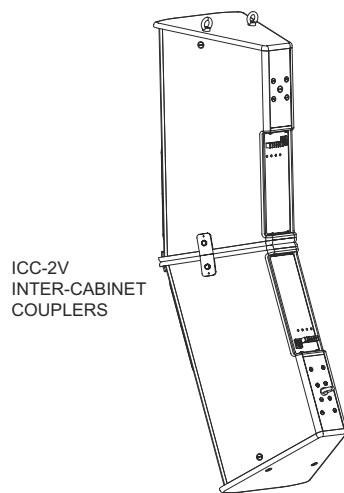

ICC-2V  
INTER-CABINET  
COUPLERS

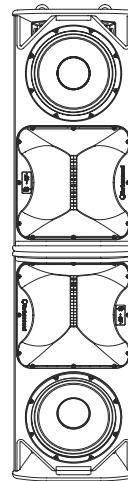

ICC-3H INTER-CABINET  
COUPLERS & FP-1 FLYPLATES

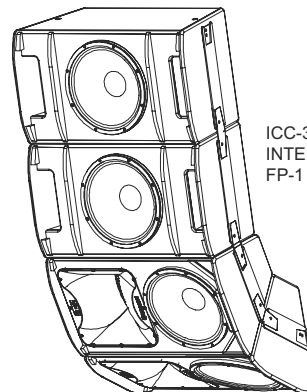
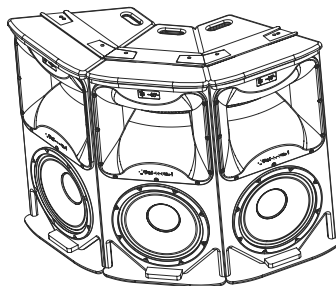

ICC-3H, ICC-4H & ICC-5H  
INTER-CABINET COUPLERS  
FP-1 & FP-2 FLYPLATES

## TCS SERIES ENGINEERING INFORMATION

The cabinet is equipped with internal M10 rigging points on the top, bottom, sides and rear which enable it to be rigged in permanent installations using M10 shoulder eyebolts. A pull-back rigging point on the rear of the cabinet is used to adjust the downward angle.

M8 rigging points are provided for use with WB-55 wall brackets and CB-55 ceiling brackets, and OmniMount™ brackets.

### INSTALLATION HARDWARE

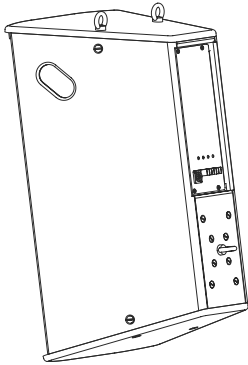

M10 EYEBOLTS

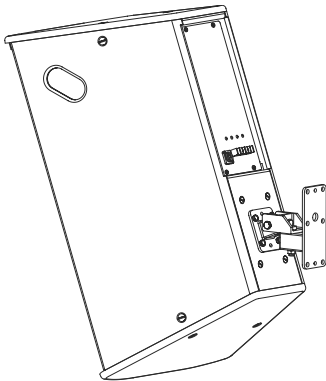
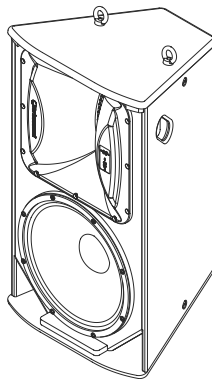

WB-55  
WALL BRACKET

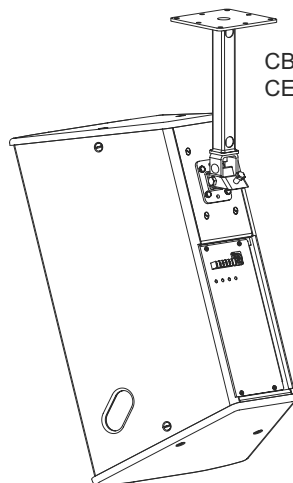

CB-55  
CEILING BRACKET

**ARCHITECTURAL  
 & ENGINEER'S  
 SPECIFICATIONS**

The loudspeaker shall be of the full range, two-way switchable active/passive type or optional digitally self-powered type consisting of one 15" (381mm) LF driver and one 1.4" (35mm) HF driver. Performance specifications of a typical production unit shall meet or exceed the following: frequency response, measured with swept sine wave input, shall be flat within  $\pm 3\text{dB}$  from 65Hz to 20kHz; and within  $\pm 10\text{dB}$  from 45Hz to 20kHz. Nominal dispersion, at -6dB points, shall average 60°H x 40°V (TCS-152/64), 90°H x 60°V (TCS-152/96), 90°H x 40°V (TCS-152/94). Nominal impedance shall be LF: 8 ohms, HF: 8 ohms; passive: 8 ohms. Power handling shall be HF: 100 watts r.m.s., 200 watts program; LF: 500 watts r.m.s., 1000 watts program; passive: 500 watts r.m.s., 1000 watts program. Sensitivity, measured with 1 watt input at 1 metre distance on axis, mean averaged over stated bandwidth, shall be LF: 95dB, HF: 104dB, passive: 95dB, 1 watt @ 1 metre. Maximum SPL (peak) measured with music program at stated amplifier input shall be LF: 128dB; HF: 130dB; passive: 128dB. Dimensions: 838mm x 469mm x 433mm (33" x 18.5" x 17"). Weight: 36kg (79.2lbs) [38kg (83.6lbs) TCS-152DP]. The loudspeaker system shall be the Turbosound TCS-152 [TCS-152DP]. No other loudspeaker shall be acceptable unless submitted data from an independent test laboratory verify that the above combined performance / size specifications are equalled or exceeded.

**DIMENSIONS**

