

TASCAM

TEAC Professional Division

D00964620A

CD-RW900SL

CD Rewritable Recorder

Professional

OWNER'S MANUAL

COMPACT
disc
ReWritable
High Speed

MP3

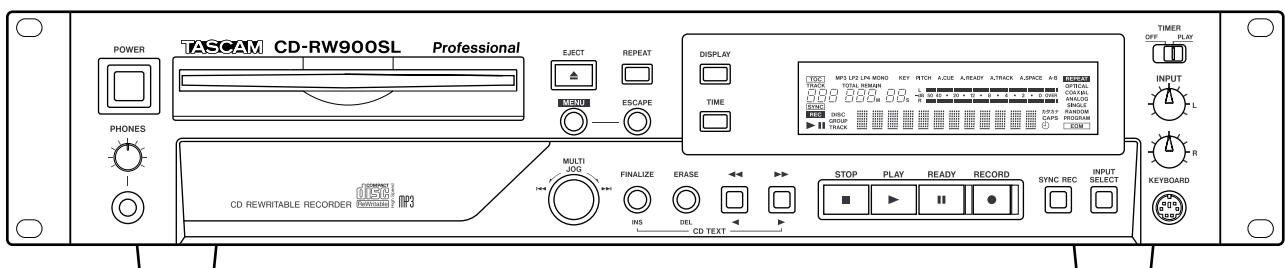

IMPORTANT SAFETY PRECAUTIONS



CAUTION
RISK OF ELECTRIC SHOCK
DO NOT OPEN



CAUTION: TO REDUCE THE RISK OF ELECTRIC SHOCK, DO NOT REMOVE COVER (OR BACK). NO USER-SERVICEABLE PARTS INSIDE. REFER SERVICING TO QUALIFIED SERVICE PERSONNEL.



The lightning flash with arrowhead symbol, within equilateral triangle, is intended to alert the user to the presence of uninsulated "dangerous voltage" within the product's enclosure that may be of sufficient magnitude to constitute a risk of electric shock to persons.



The exclamation point within an equilateral triangle is intended to alert the user to the presence of important operating and maintenance (servicing) instructions in the literature accompanying the appliance.

This appliance has a serial number located on the rear panel. Please record the model number and serial number and retain them for your records.

Model number _____

Serial number _____

WARNING: TO PREVENT FIRE OR SHOCK HAZARD, DO NOT EXPOSE THIS APPLIANCE TO RAIN OR MOISTURE.

For U.S.A.

TO THE USER

This equipment has been tested and found to comply with the limits for a Class A digital device, pursuant to Part 15 of the FCC Rules. These limits are designed to provide reasonable protection against harmful interference when the equipment is operated in a commercial environment. This equipment generates, uses, and can radiate radio frequency energy and, if not installed and used in accordance with the instruction manual, may cause harmful interference to radio communications.

Operation of this equipment in a residential area is likely to cause harmful interference in which case the user will be required to correct the interference at his own expense.

CAUTION

Changes or modifications to this equipment not expressly approved by TEAC CORPORATION for compliance could void the user's authority to operate this equipment.

For the customers in Europe

WARNING

This is a Class A product. In a domestic environment, this product may cause radio interference in which case the user may be required to take adequate measures.

Pour les utilisateurs en Europe

AVERTISSEMENT

Il s'agit d'un produit de Classe A. Dans un environnement domestique, cet appareil peut provoquer des interférences radio, dans ce cas l'utilisateur peut être amené à prendre des mesures appropriées.

Für Kunden in Europa

Warnung

Dies ist eine Einrichtung, welche die Funk-Entstörung nach Klasse A besitzt. Diese Einrichtung kann im Wohnbereich Funkstörungen verursachen; in diesem Fall kann vom Betreiber verlangt werden, angemessene Maßnahmen durchzuführen und dafür aufzukommen.

CE Marking Information

- a) Applicable electromagnetic environment: E4
- b) Peak inrush current: 5.5 A

IMPORTANT SAFETY INSTRUCTIONS

- 1 Read these instructions.
 - 2 Keep these instructions.
 - 3 Heed all warnings.
 - 4 Follow all instructions.
 - 5 Do not use this apparatus near water.
 - 6 Clean only with dry cloth.
 - 7 Do not block any ventilation openings. Install in accordance with the manufacturer's instructions.
 - 8 Do not install near any heat sources such as radiators, heat registers, stoves, or other apparatus (including amplifiers) that produce heat.
 - 9 Do not defeat the safety purpose of the polarized or grounding-type plug. A polarized plug has two blades with one wider than the other. A grounding type plug has two blades and a third grounding prong. The wide blade or the third prong are provided for your safety. If the provided plug does not fit into your outlet, consult an electrician for replacement of the obsolete outlet.
 - 10 Protect the power cord from being walked on or pinched particularly at plugs, convenience receptacles, and the point where they exit from the apparatus.
 - 11 Only use attachments/accessories specified by the manufacturer.
 - 12 Use only with the cart, stand, tripod, bracket, or table specified by the manufacturer, or sold with the apparatus. When a cart is used, use caution when moving the cart/apparatus combination to avoid injury from tip-over.
- Do not expose this apparatus to drips or splashes.
 - Do not place any objects filled with liquids, such as vases, on the apparatus.
 - Do not install this apparatus in a confined space such as a book case or similar unit.
 - The apparatus draws nominal non-operating power from the AC outlet with its STANDBY/ON in the Standby position.
 - The apparatus should be located close enough to the AC outlet so that you can easily grasp the power cord plug at any time.
 - An apparatus with Class I construction shall be connected to an AC outlet with a protective grounding connection.
 - Batteries (battery pack or batteries installed) should not be exposed to excessive heat such as sunshine, fire or the like.
 - Excessive sound pressure from earphones and headphones can cause hearing loss.



- 13 Unplug this apparatus during lightning storms or when unused for long periods of time.
- 14 Refer all servicing to qualified service personnel. Servicing is required when the apparatus has been damaged in any way, such as power-supply cord or plug is damaged, liquid has been spilled or objects have fallen into the apparatus, the apparatus has been exposed to rain or moisture, does not operate normally, or has been dropped.

Safety Information

This product has been designed and manufactured according to FDA regulations "title 21, CFR, chapter 1, subchapter J, based on the Radiation Control for Health and Safety Act of 1968", and is classified as a class 1 laser product. There is no hazardous invisible laser radiation during operation because invisible laser radiation emitted inside of this product is completely confined in the protective housings.

The label required in this regulation is shown at ①.

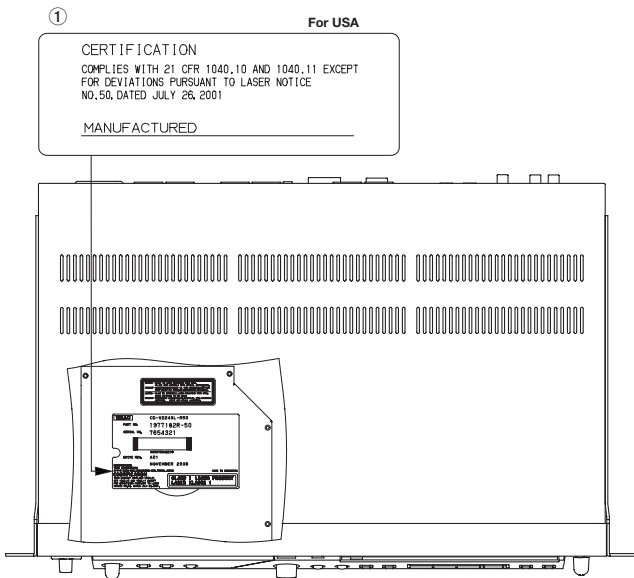

CAUTION

- DO NOT REMOVE THE PROTECTIVE HOUSING USING A SCREWDRIVER.
- USE OF CONTROLS OR ADJUSTMENTS OR PERFORMANCE OF PROCEDURES OTHER THAN THOSE SPECIFIED HEREIN MAY RESULT IN HAZARDOUS RADIATION EXPOSURE.
- IF THIS PRODUCT DEVELOPS TROUBLE, CONTACT YOUR NEAREST QUALIFIED SERVICE PERSONNEL, AND DO NOT USE THE PRODUCT IN ITS DAMAGED STATE.
- CLASS 1M INVISIBLE LASER RADIATION WHEN OPEN AND INTERLOCKS DEFEATED. DO NOT VIEW DIRECTLY WITH OPTICAL INSTRUMENTS.

Optical pickup:

Type : HOP-6201T

Manufacturer : Hitachi Media Electronics Co,Ltd.

Laser output : Less than 75 mW on the objective lens (record)

Wavelength : 777 to 787 nm

For China

产品有毒有害物质或元素的名称及含量

机种: CD-RW900SL		有毒有害物质或元素					
品名	铅 (Pb)	汞 (Hg)	镉 (Cd)	六价铬 (Cr(VI))	多溴联苯 (PBB)	多溴二苯醚 (PBDE)	
1 CHASSIS部份	○	○	○	○	○	○	
2 FRONT PANEL部份	○	○	○	○	○	○	
3 螺丝部份	○	○	○	○	○	○	
4 线材部份	○	○	○	○	○	○	
5 PCB Assy部份	×	○	○	○	○	○	
6 DRIVE UNIT部份	×	○	○	○	○	○	
7 电源部份	○	○	○	○	○	○	
8 附属品部份	○	○	○	○	○	○	
9 LABEL部份	○	○	○	○	○	○	
10 包装部份	○	○	○	○	○	○	

○: 表示该有毒有害物质在该部件所有均质材料中的含有量均在 SJ/T11363-2006 标准规定的限量要求以下。

×: 表示该有毒有害物质至少在该部件的某一均质材料中的含量超出 SJ/T11363-2006 标准规定的限量要求。

(针对现在代替技术困难的电子部品及合金中的铅)

1 – Introduction	6	Basic recording	24
Supplied accessories	6	Time display while recording	24
Rack-mounting the unit.....	6	Full disc.....	24
About this manual	6	Advanced recording.....	25
About CD-R and CD-RW discs	7	Fade-in and fade-out recording	25
About finalizing	7	Synchronized recording	25
Recordable discs	7	Sync recording	25
Environmental considerations	8	Automatic track division.....	26
Handling of compact discs.....	8	To enable or disable automatic track division:.....	26
Never use a stabilizer or printable discs.....	8	Manually divide track.....	26
Beware of condensation.....	9	Rec mute function	27
Use of the remote control unit	9	Restricting the number of tracks	27
Batteries	9		
Inserting batteries.....	9	6 – After recording.....	28
Connections.....	9	Finalizing.....	28
2 – Features of the CD-RW900SL.....	10	Unfinalizing CD-RW discs	28
Front panel	10	Erasing	29
Rear panel.....	11	Erasing tracks.....	29
Display	12	Erasing a whole disc.....	29
RC-RW900SL Remote control unit	13	Refreshing a disc	29
3 – Menu operation	14		
Menu configuration	14	7 – Titling.....	30
Operation basics	15	Title input operation.....	30
4 – Playback operations.....	16	Disc title input.....	30
Discs for playback	16	Track title input.....	30
Simple playback operations	16	Using a keyboard with the CD-RW900SL....	31
Track selection.....	16	Keyboard type setting	31
Using the skip function.....	16	Title input by keyboard.....	31
Selecting by track number.....	17	Other keyboard operations	31
Track search	17	8 – Reference and specifications.....	32
Normal search.....	17	Error messages	32
Direct search	17	Messages during operations.....	32
Basic operation	17	Troubleshooting	33
Operation variations	17	Specifications	34
Specifying a track number only	17	Dimensional drawing.....	35
Specifying to the minute	17		
Playback modes.....	18		
Continuous playback.....	18		
Single-track playback.....	18		
Random playback	18		
Program playback.....	18		
Time display switching	19		
Timer playback	19		
Repeat playback.....	19		
A to B repeat playback	20		
Auto Cue function.....	20		
Auto Ready function.....	20		
Pitch control function	20		
Key control function	21		
Playing back MP3 files	21		
About MP3 track data	22		
Directory playback setting	22		
MP3 action setting	22		
5 – Recording.....	23		
Input selection.....	23		
Input monitoring	23		
Frequency conversion	23		

1 – Introduction

Thank you for your purchase of the TASCAM CD-RW900SL CD rewritable recorder.

Before connecting and using the unit, please take time to read this manual thoroughly to ensure you understand how to properly set up and connect the CD-RW900SL, as well as the operation of its many useful and convenient functions. After you have finished reading this manual, please keep it in a safe place for future reference.

NOTE

This product is designed to help you record and reproduce sound works to which you own the copyright, or where you have obtained permission from the copyright holder or the rightful licensor. Unless you

own the copyright, or have obtained the appropriate permission from the copyright holder or the rightful licensor, your unauthorized recording, reproduction or distribution thereof may result in severe criminal penalties under copyright laws and international copyright treaties. If you are uncertain about your rights, contact your legal advisor. Under no circumstances will TEAC Corporation be responsible for the consequences of any illegal copying performed using the CD-RW900SL.

Supplied accessories

In addition to this manual, the CD-RW900SL has been packed with the following:

- RC-RW900SL remote control unit..... 1
- AC power cable 1
- A rack-mounting screw kit (screws and washers)..... 1
- A warranty card 1
- AAA batteries for the remote control unit..... 2

Contact your TASCAM supplier if any of these items are missing.

NOTE

The batteries are not supplied for Taiwan.

Rack-mounting the unit

If you are mounting the unit in a rack, leave 1U of space above it and 4 inch (10 cm) or more of space at the rear.

Use the rack-mounting kit to mount the unit in a standard 19-inch equipment rack, as shown in this section. Remove the feet of the unit before mounting.

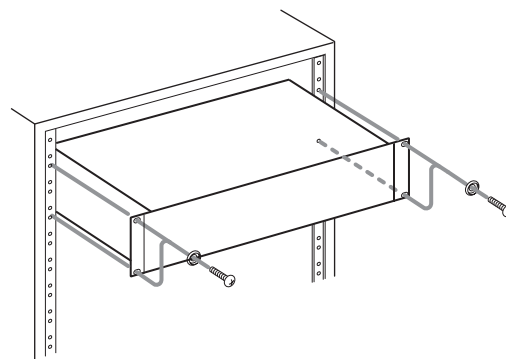

About this manual

In this manual, we use the following conventions:

- The names of keys and controls are given in the following typeface: **ERASE**.
- When the alphanumeric portion of the display shows a message, this is shown in the following typeface: `Complete`
- If a preset indicator in the display (i.e. one which cannot change, but is either on or off) is shown, this is shown as follows: **RANDOM**.
- Selectable value (i.e. values of dB) or ON and OFF selection (i.e. SRC>XXX) is shown in the following typeface: `XXX`

About CD-R and CD-RW discs

CD-R discs can be recorded once only. Once they have been used for recording, they cannot be erased or re-recorded. However, if space is available on the disc, additional material can be recorded. The packaging of CD-R discs will include one of the following logos:



By contrast, a CD-RW disc can be used in much the same way as a CD-R disc, but the last track or tracks recorded can be erased before the disc has been “finalized”, and the space on the disc can be re-used for other recordings. The packaging of CD-RW discs will include the logo one of the following logos:



However, you should note that an audio CD created using a CD-RW disc may not play back satisfactorily on every audio CD player. It will, naturally, be playable on the CD-RW900SL. This is in no way a limitation of the CD-RW900SL itself, but of the difference between the different types of media and the methods used to read them.

There are precautions that you should take when handling CD-R and CD-RW discs.

- Avoid touching the recording (non-label) side of a disc on which you will be recording. Recording on a disc requires a cleaner surface than playing back, and fingerprints, grease, etc. can cause errors in the recording process.

About finalizing

Although audio data may be written on a CD-R or CD-RW disc, a standard CD player will not be able to read the data (i.e. play back the audio) until a final *TOC has been written at the start of the disc.

***TOC:Table of contents**

Information of recorded data, which contains titles, starting and ending addresses, and etc..

The process of writing this table of contents is known as “finalizing”. Once this has been done, no further data can

- CD-R and CD-RW discs are sensitive to the effects of heat and ultraviolet rays. It is important that they are not stored in a location where direct sunlight will fall on them, and which is away from sources of heat such as radiators or heat-generating electrical devices.
- Always store CD-R and CD-RW discs in their cases to avoid dirt and dust accumulating on their surfaces.
- When labeling CD-R and CD-RW discs, always use a soft oil-based felt-tipped pen to write the information. Never use a ball-point or hard-tipped pen, as this may cause damage to the recorded side.
- Always keep the recording sides of the discs away from grime and dust to avoid a reduction in sound quality. To clean a disc, wipe gently with a soft dry cloth from the center towards the outside edge. Do not use thinner, gasoline, benzene or LP cleaning fluid, as these will damage the disc and cause the disc unplayable.
- Do not put labels or protective sheets on the discs and do not use any protective coating spray.
- If you are in any doubt as to the care and handling of a CD-R and CD-RW discs, read the precautions supplied with the disc, or contact the disc manufacturer directly.

be written to the disc. See “Finalizing” on page 28 for details. In the case of a CD-RW disc which has been finalized, the whole of the disc may be erased, or the disc may be “refreshed”, and the disc re-used.

In addition, a CD-RW disc that has been finalized may be “unfinalized”, i.e. only the TOC is removed. This allows further tracks to be recorded to the disc, provided that there is space on the disc.

Recordable discs

In this manual, we use the term “recordable” disc to describe a CD-R or CD-RW disc that has not been finalized, i.e. further recording is possible on the disc.

1 – Introduction

Environmental considerations

The CD-RW900SL may be used in most areas, but to maintain top performance, and prolong operating life, observe the following environmental conditions:

- The nominal temperature should be between 5°C and 35°C (41°F and 95°F).
- Relative humidity should be 30 to 90 percent.
- As the unit may become hot during operation, always leave sufficient space above the unit for ventilation. Do not install this unit in a confined space such as a bookcase, and do not put anything on top of the unit.

- Avoid installing this unit on top of any heat-generating electrical device such as a power amplifier.
- Make sure that the unit is mounted in a level position for correct operation.

NOTE

The voltage supplied to the unit should match the voltage as printed on the rear panel. If you are in any doubt regarding this matter, consult an electrician.

Handling of compact discs

The CD-RW900SL has been designed for the playback of CD-DA (standard audio) format discs and MP3 files recorded on the discs using the ISO9660 format: In addition to ordinary 5-inch and 3-inch CDs, it can also play properly recorded CD-R and CD-RW discs.

- Always insert the compact discs into the unit with their label facing upward.
- To remove a disc from its case, press down on the center of the disc holder, then lift the disc out, holding it carefully by the edges.

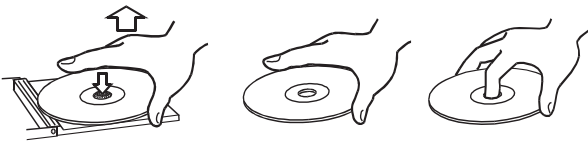

- Avoid getting fingerprints on the signal side (the non-label side). Grime and dust may cause skipping, so keep discs clean and store them in their cases when not being played. To clean the signal side of a disc, wipe gently with a soft dry cloth from the center towards the outside edge.



- Do not use any record spray, anti-static solutions, benzene, paint thinner or other chemical agents to clean CDs as they could damage the delicate playing surface. It may cause CDs to become unplayable.

- Discs should be returned to their cases after use to avoid serious scratches that could cause the laser pickup to “skip.”
- Keep discs away from direct sunlight, and places of high heat and humidity. If left in such places, warping could result.
- Do not affix any labels or stickers to the label side of the disc. Do not write on the disc with a ballpoint pen.
- Do not insert discs that have adhesive remaining from tape or stickers that have been removed. If they are inserted into the player, they could stick to the internal mechanism, requiring removal by a technician.
- Do not use cracked discs.
- Only use circular compact discs. Avoid using non-circular promotional, etc. discs.

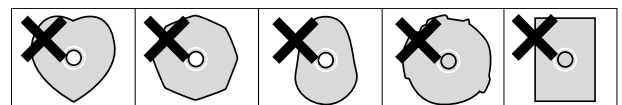

- Music discs with copy control, a copy-protection system, have been released from several record companies in an attempt to protect the copyright. Since some of these discs do not comply with the CD specifications, they may not be playable on the CD-RW900SL.

Never use a stabilizer or printable discs

Using commercially available CD stabilizers or printable recordable discs with this player will damage the mechanism and cause it to malfunction.

NOTE

Never use a disc that has had a stabilizer mounted to it. The residual adhesive may cause the disc to stick to the turntable of the CD-RW900SL. If it sticks to the turntable, you will need a technician to get it out.

1 – Introduction

Beware of condensation

If the unit (or a compact disc) is moved from a cold to a warm place, or used after a sudden temperature change, there is a danger of condensation; vapor in the air could condense on the internal mechanism, making correct oper-

ation impossible. To prevent this, or if this occurs, let the player sit for one or two hours at the new room temperature before using.

Use of the remote control unit

- Do not expose the infra-red receiver (light receptive area on the front panel) to direct sunlight or intense light for extended periods of time. Long exposure to this light may result in failure of the remote control sensor.
- When the remote control will not be used over one month, please remove the batteries to prevent the possibility of battery acid leakage which could damage the unit. Should leakage occur, remove and discard the batteries, and wipe the battery case thoroughly with a cloth. Avoid getting the battery liquid on the skin. After cleaning, replace with new batteries.
- The remote control functions by using an infrared light signal. When using the unit to control the CD-RW900SL, other devices that are turned on could be operated by its signal.
- If the range of remote operation becomes smaller, or commands do not always function properly, the batteries have become weak and should be replaced. Always replace both batteries with new batteries of the same type.
- Point the remote control to the remote sensor on the main unit. Do not obstruct the path between the remote control and the remote sensor.

Batteries

If batteries are used improperly, or if leakage or breakage occurs, the unit will not function.

Please observe the cautions indicated on the batteries and their packaging to ensure proper usage.

- Confirm + and – polarity and follow the indications when inserting new batteries into the remote control.
- Do not use old and new batteries together.
- Even if the battery is the same size, the voltage may differ. Do not use batteries of different specifications together.
- Do not attempt to recharge batteries that are non-rechargeable.
- Do not open or disassemble batteries, throw them into a fire or put them in water.

■ Inserting batteries

1. Open the lid.
2. Confirm +/- polarity, and insert two AAA batteries.
3. Close the lid.

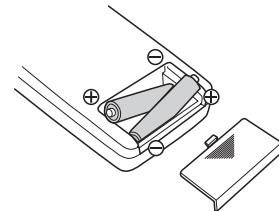

Connections

The following should be noted when you connect the unit to other equipment.

It is possible to connect the unit's DIGITAL COAXIAL IN, DIGITAL OPTICAL IN and ANALOG UNBALANCED INs (L, R) to other equipment at the same time. However, the unit can receive signals from only one digital input at a time.

Currently selected input jack is shown on the display.

Audio signals output from the unit are output from the analog ANALOG OUT jacks, as well as from the DIGITAL COAXIAL OUT jack and DIGITAL OPTICAL OUT connector simultaneously (but not from the digital outputs in stop mode).

2 – Features of the CD-RW900SL

Front panel

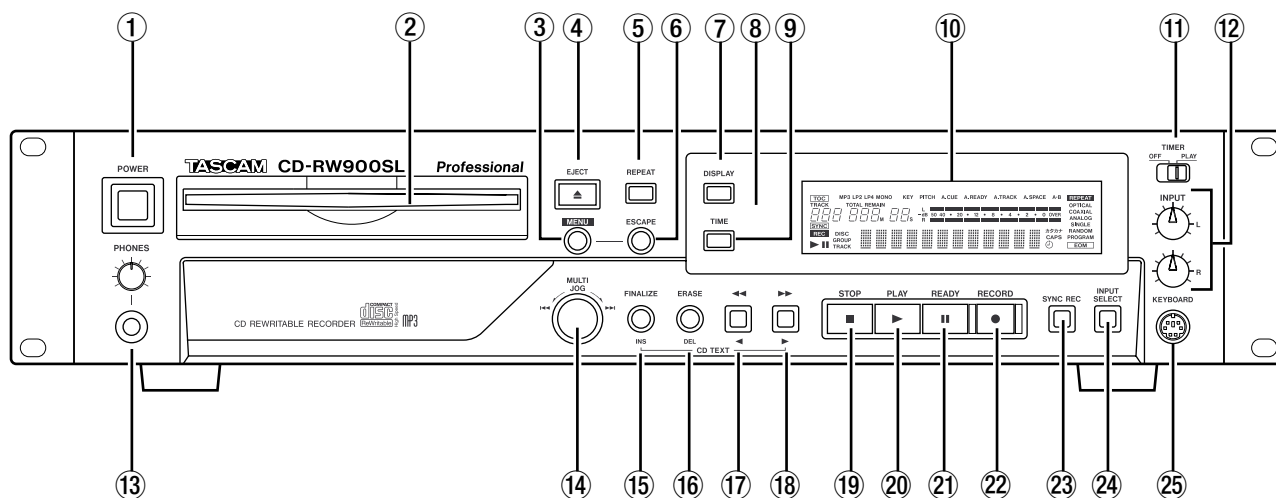

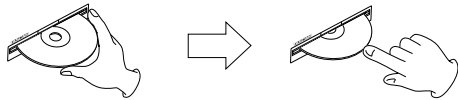
- ① **POWER switch** The power switch is used to switch the unit on and off.
- ② **Disc slot** Discs should be inserted label side upwards into the unit's slot.
Gently slide in a disc until the unit pulls the disc in. Note that if the unit does not pull the disc in, press the **EJECT** key to cancel the action. Do not force the disc in further to avoid damage to the unit.

- ③ **MENU key** Use this key to call up the menu options (see "Operation basics" on page 15).
- ④ **EJECT key** Use this key to eject the currently loaded disc. The display shows *Disc Eject*.
- ⑤ **REPEAT key** Use this key to set the repeat playback mode on and off.
- ⑥ **ESCAPE key** When in a menu mode, this key cancels the menu item selected.
- ⑦ **DISPLAY key** Use this key to see the current disc title when the disc is stopped. When the disc is playing or in ready mode, press this key to see the current track title.
- ⑧ **REMOTE SENSOR** This is the sensor for the remote control unit. Make sure that there is a clear path from the remote control unit to the sensor.
- ⑨ **TIME key** Use this key to cycle through the time modes shown on the display (see "Time display switching" on page 19).
- ⑩ **Display** The display is used to show the current status of the unit, as well as the current menu settings.
- ⑪ **TIMER switch (PLAY, OFF)** Using this key switches Timer play on and off. See "Timer playback" on page 19 for details.
- ⑫ **INPUT (L,R) controls** Use these concentric controls to adjust the level of the analog audio signals received at the **ANALOG IN** jacks.
- ⑬ **PHONES jack and the level control** Use a standard pair of stereo headphones, equipped with a 1/4-inch plug, with this jack.
Adjust the volume from the jack with the level control (turn clockwise for higher volume).
- ⑭ **MULTI JOG dial** Use this dial to select tracks for playback, to set parameter values.
In addition, pushing the dial acts like an **ENTER** key, i.e. the currently-displayed value or setting is confirmed.
- ⑮ **FINALIZE/INS key** Use this key to finalize recordable discs (see "Finalizing" on page 28).
It also acts like a space key when entering **TEXT** data (see "Title input operation" on page 30).
- ⑯ **ERASE/DEL key** Use this key (with CD-RW discs only) to erase tracks, or a whole disc, or to refresh a "bad" disc, or to unfinalize a finalized disc (see "Erasing" on page 29 for details).
It also acts like a delete key when entering **TEXT** data (see "Title input operation" on page 30).
- ⑰ **<</> key** Use this key to operate review playback (search) while in playback or ready modes.
When Directory search is on, and when stopped, using this key selects the directory.
This key also moves the cursor in the left direction when entering **TEXT** data.
- ⑱ **>>/> key** Use this key to operate cue playback (search) while in playback or ready modes.

2 – Features of the CD-RW900SL

When Directory search is on, and when stopped, using this key selects the directory.

This key also moves the cursor in the right direction when entering TEXT data.

- ⑲ **STOP key** Use this key to stop playback or recording.
- ⑳ **PLAY key** Use this key to start or resume playback or recording.
- ㉑ **READY key** Use this key to standby for playback or recording.
- ㉒ **RECORD key** Use this key to enter record ready mode (see “Basic recording” on page 24 for details) and also to enter manual track divisions (see “Manually divide track” on page 26).
- ㉓ **SYNC REC key** Use this key to turn synchronized recording on and off before starting to record (see “Synchronized recording” on page 25 for details).

⑳ **INPUT SELECT** Use this key to select the different audio inputs and the input combinations (see “Input selection” on page 23 for full details).

㉔ **KEYBOARD jack** An IBM PC-compatible keyboard with PS/2 interface can be connected to this terminal to enable certain operations of the CD-RW900SL with the keyboard. Title input operations, in particular, can be performed with greater efficiency.

Rear panel

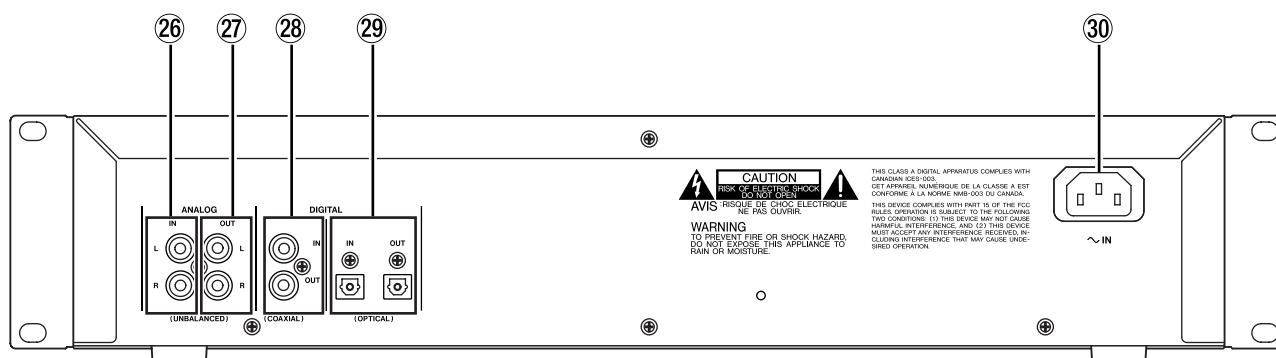

- ⑳ **ANALOG IN (UNBALANCED) (L, R)** These RCA jacks accept analog audio signals from suitably-equipped units (at -10 dBV).
- ㉑ **ANALOG OUT (UNBALANCED) (L, R)** These RCA jacks output analog audio signals (at -10 dBV levels) to suitably-equipped units.
- ㉒ **DIGITAL COAXIAL (IN, OUT)** These two RCA jacks accept and output digital audio in standard consumer format (SPDIF).
- ㉓ **DIGITAL OPTICAL (IN, OUT)** These two TOSLINK optical connectors accept and output digital audio using optical fiber connectors.
- ㉔ **AC IN jack** Connects the power cable supplied.

2 – Features of the CD-RW900SL

Display

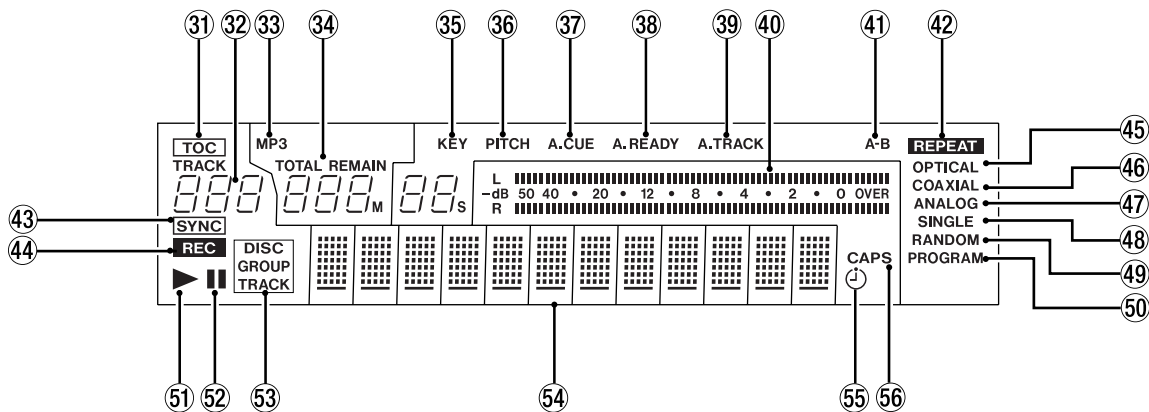

This display shows various types of operation information, including CD disc information, deck operation modes, and menu status.

③① **TOC** The **TOC** indicator lights up red when a loaded disc contains TOC (Table of Contents) data.

③② **Track number display** During playback or selection, the track number is displayed.

When Incremental playback is on, and when in playback or playback ready mode, the **TRACK** indicator blinks.

③③ **MP3** The **MP3** indicator lights when a MP3 disc is in the deck.

③④ **Counter display** Depending on the time display mode, **TOTAL** or **REMAIN** are lit. The counter display indication are in minutes (three digits) and seconds (two digits).

③⑤ **KEY** The **KEY** indicator lights when Key Control is on.

③⑥ **PITCH** The **PITCH** indicator lights when Pitch Control is on.

③⑦ **A.CUE** The **A.CUE** indicator lights when Auto Cue is on.

③⑧ **A.READY** The **A.READY** indicator lights when Auto Ready is on.

③⑨ **A. TRACK** The **A.TRACK** indicator lights when the Auto Track is on.

④① **Meter** This displays the playback level, as well as the input level of the source device.

④① **A-B** The **A-B** indicator lights when the A-B repeat function is on.

Also, this flashes until a “B-point” is entered.

④② **REPEAT** The **REPEAT** indicator lights when the Repeat function is on.

④③ **SYNC** The **SYNC** indicator lights up when SYNC is on.

④④ **REC** When the SRC function is on, this lights during recording, or in recording standby mode.

When the SRC function is off, this flashes during recording, or in recording standby mode.

④⑤ **OPTICAL** The **OPTICAL** indicator lights when the input source is set to optical.

④⑥ **COAXIAL** The **COAXIAL** indicator lights when the input source is set to coaxial.

④⑦ **ANALOG** The **ANALOG** indicator lights up when the input source is set to analog.

④⑧ **SINGLE** The **SINGLE** indicator lights when Single Playback mode is set.

④⑨ **RANDOM** This **RANDOM** indicator lights when Random Playback mode is set.

⑤① **PROGRAM** The **PROGRAM** indicator lights when Program Playback mode is set.

⑤① **▶** This lights during playback, and also blinks during Auto Cue point search.

⑤② **||** This lights during playback or recording standby mode.

⑤③ **DISC, GROUP, TRACK display** The **DISC** indicator lights up when a disc loaded and is stopped.

The **GROUP** indicator lights up when MP3 Directory playback mode is on.

The **TRACK** indicator lights up during playback or recording, also during playback or recording standby mode.

⑤④ **Character display** Disc information, track information, menu, message, time, and operation status are displayed here.

⑤⑤ **⌚** This lights when the Timer Play function is on.

⑤⑥ **CAPS** The **CAPS** indicator lights during title input to indicate CAPS mode is on. In lower case letter mode, there is no indication.

2 – Features of the CD-RW900SL

RC-RW900SL Remote control unit

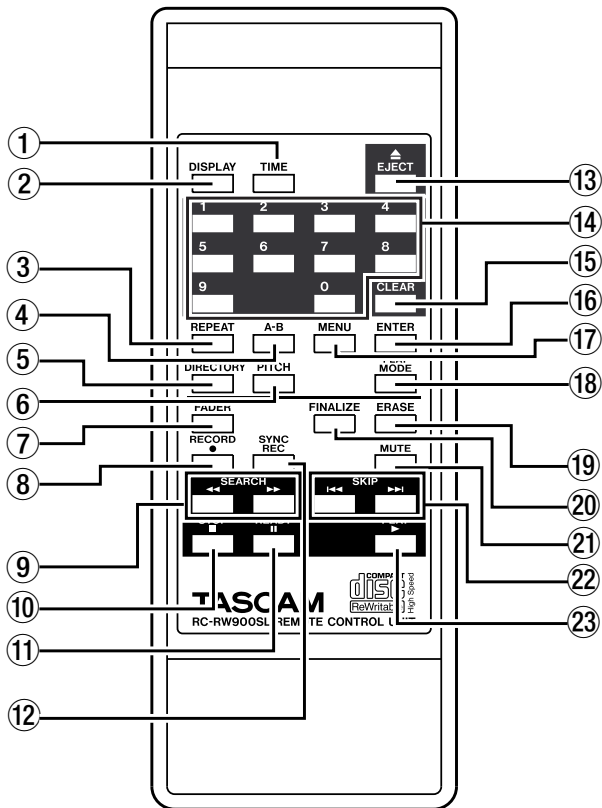

- ① **TIME key** Press this key to cycle through the time display modes.
- ② **DISPLAY key** Press this key to see the current disc title when the disc is stopped, or the current track title while in playback or ready mode.
When entering TEXT data, using this key switches the text characters.
- ③ **REPEAT key** Changes between the various repeat modes when playing back (see “Repeat playback” on page 19).
- ④ **A-B key** Sets the A to B repeat points and playback mode (see “A to B repeat playback” on page 20).
- ⑤ **DIRECTORY key** Use this key to switch MP3 file directory playback on and off.
- ⑥ **PITCH key** Switches pitch control on and off.
- ⑦ **FADER key** Use this key to start fade-in recordings or to start a fade-out when recording (see “Fade-in and fade-out recording” on page 25 for details).
- ⑧ **RECORD key** Use this key to enter record ready mode.
- ⑨ **SEARCH keys (◀◀/▶▶)** Use these keys to move the playback position inside a track.
- ⑩ **STOP key** Use this key to stop playback or recording.

- ⑪ **READY key** Use this key to standby for playback or recording.
- ⑫ **SYNC REC key** Use this key to turn synchronized recording on and off (see “Synchronized recording” on page 25 for details).
- ⑬ **EJECT key** Ejects the loaded disc from the unit.
- ⑭ **Number keys (0 through 9)** Use these keys for direct entry of track numbers when playing back, or making a programmed play list.
- ⑮ **CLEAR key** Clears a mistaken entry made with the number keys.
In the program mode, pressing this key cancels the program entered at the last.
It also acts like the **ESCAPE** key in the Menu mode.
- ⑯ **ENTER key** Pressing this key is equivalent to pressing the **MULTI JOG** dial to confirm an entry.
- ⑰ **MENU key** Switches the menu mode on or off.
- ⑱ **PLAY MODE key** Use this key to choose between the different playback modes (single play, continue play, etc.).
- ⑲ **ERASE key** Erases tracks (CD-RW discs only), or a whole disc, or to refresh a “bad” disc, or to unfinalize a finalized disc (see “Erasing” on page 29 for details).
- ⑳ **FINALIZE key** Finalizes recordable discs. See “Finalizing” on page 28 for details.
- ㉑ **REC MUTE key** Use this key when recording, to mute the input signal for about four seconds and then to enter record ready mode (see “Rec mute function” on page 27).
- ㉒ **SKIP (◀◀/▶▶) keys** Use these keys to move between tracks when playing back (equivalent to rotating the **MULTI JOG** dial).
- ㉓ **PLAY key** Use this key to start playback, or enter record mode from record ready mode.

3 – Menu operation

The various settings and editing operations possible with the CD-RW900SL are performed through menu options shown on the display. Among the many menu setting options, some may be made directly using the keys on the remote control.

Menu configuration

The menus are configured as shown below. Please see the reference page for more details of each menu.

Menu option	Sub-Menu option	Function	Reference page
PLAY	PLAY MODE	Playback mode settings	P18 (“Playback modes”)
	PITCH	Pitch control mode on/off	P20 (“Pitch control function”)
	PITCH CONT	Pitch control setting	P20 (“Pitch control function”)
	PITCH STEP	Pitch control variable pitch setting	P20 (“Pitch control function”)
	KEY	Key control mode on/off	P21 (“Key control function”)
	KEY LEVEL	Key control level setting	P21 (“Key control function”)
	DIRECTORY	MP3 disc directory mode on/off	P21 (“Playing back MP3 files”)
	MP3 ACTION	MP3 disc playback error setting	P22 (“MP3 action settings”)
	READ SPEED	data reading speed setting	P16 (“Simple playback operations”)
	A_READY	Auto ready on/off	P20 (“Auto Ready function”)
	A_CUE	Auto cue on/off	P20 (“Auto Cue function”)
	A_CUE LEVEL	Auto Cue level setting	P20 (“Auto Cue function”)
REC	VOLUME	Input level setting	P23 (“Input selection”)
	FADE IN	Fade-in time setting	P25 (“Fade-in and fade-out recording”)
	FADE OUT	Fade-out time setting	P25 (“Fade-in and fade-out recording”)
	SRC	Sampling rate converter on/off	P23 (“Frequency conversion”)
	SYNC LEVEL	Sync recording operating level	P25 (“Sync recording”)
	A_TRK	Auto track on/off	P26 (“Automatic track division”)
	A_TRK LEVEL	Auto track operating level	P26 (“Automatic track division”)
TEXT	TEXT EDIT	Text setting	P30 (“Title input operation”)
SYSTEM	KEYBOARD	setting for keyboard type	P31 (“Keyboard type setting”)
	PLAY TIME	Display total playing time	P16 (“Simple playback operations”)
	REC TIME	Display total recording time	P24 (“Basic recording”)
	IR REMOTE	Remote control setting	P15 (“Operation basics”)
	F_PRESET	Reset to the factory setting	P15 (“Operation basics”)

3 – Menu operation

Operation basics

1. Select the desired menu option.

Press the MENU key on the front panel or remote control to call up the desired menu. The menu option PLAY will be shown on the display at first.

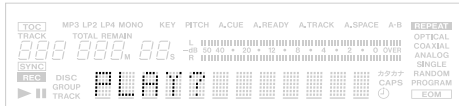

Front panel operation: Rotate the MULTI JOG dial to select the desired menu option, then push the dial to confirm.

Remote control operation: Use the SKIP key to cycle through the different menu options, then press the ENTER key to confirm.

The sub-menu option screen of the selected menu will be displayed.

If the PLAY menu option is selected, the sub-menu option shows up like this:

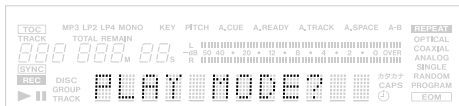

NOTE

Return to the menu option selection screen, press the ESCAPE key on the front panel or the CLEAR key on the remote control.

2. Select the desired sub-menu.

Front panel operation: Rotate the MULTI JOG dial to select the desired sub-menu, then push the dial to enter the selection.

Remote control operation: Use the SKIP key to select, then press the ENTER key.

The menu item screen of the selected sub-menu will appear. If the sub-menu PLAY MODE is selected, the menu item shows up like this:

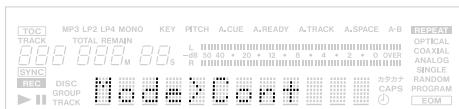

NOTE

To return to the sub-menu option selection screen, press the ESCAPE key on the front panel or the CLEAR key on the remote control.

3. Setting the desired menu item or value.

Front panel operation: Use the MULTI JOG dial to select the desired menu item or value. Pushing the dial enters and exits menu mode.

Remote control operation: Use the SKIP key. Pressing the ENTER key confirms and exits menu mode.

NOTE

Some menu options exist for confirmation purposes only, and the setting cannot be changed.

4. How to exit menu mode after setting (or confirmation), during menu option display.

Front panel operation: As well as pushing the MULTI JOG dial, you can use the MENU key to exit menu mode.

Remote control operation: Press the ENTER key to exit menu mode.

NOTE

The selected menu mode remains after power is turned off, except the TEXT menu.

To reset all the settings and return to the factory setting, use the F_PRESET sub-menu in the SYSTEM menu option. It should only be used when a disc is not loaded.

When IR REMOTE is set to Disable, some functions cannot be operated using the remote control. On the other hand, set to Enable allows any operation using the remote control.

4 – Playback operations

The CD-RW900SL can be used to play back CDs (including CD-R and CD-RW discs that have been recorded and finalized on other types of recorder), as well as CD-R discs and CD-RW discs that have been recorded on the unit.

Audio files in MP3 format on CD-ROM, CD-R and CD-RW are also playable on the unit.

Discs for playback

The CD discs in the CD-RW900SL can play back the types of discs listed below.

- Commercial pre-recorded CDs recorded in CD-DA format.
- CD-R and CD-RW discs that have been recorded in CD-DA format and finalized properly.

- MP3 files recorded in ISO9660 level 1 and level 2 format on CD-R and CD-RW discs, and properly finalized. MP3 files that are recorded to a disc with Joliet format extensions are also playable.

Simple playback operations

WARNING

If you are monitoring using headphones, first adjust the level control to low on the unit, then connect to the PHONES jack before playing back. This will prevent any possible damage to your hearing.

NOTE

The explanation in this manual will assume the user is starting from the normal Continuous mode.

1. Press the POWER switch to turn on the unit.
2. Insert a disc into the unit with the label side up.

The display shows Disc Loading. Then TOC Reading will appear with the period flashing.

When the TOC has been read, the display shows the number of tracks and total running time of the disc.

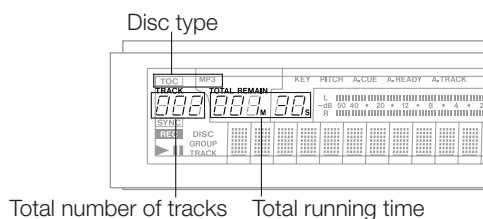

The CD-RW900SL also shows one of the following:

- TOC** A disc finalized
- MP3** A disc contains MP3 files

3. Press the PLAY key to start playback.

Adjust the connected monitor system, or the level control for the PHONES on the unit to set the listening level you desire.

NOTE

If a disc has scratch or grime, it could cause the laser pickup to "skip." In this case, set the READ SPEED sub-menu in the PLAY menu option to "High" (see "Operation basics" on page 15). This may resolve the problem, however, the unit's running sound may become louder.

4. To stop playback, press the STOP key.

To temporarily stop playback and enter playback standby mode, press the READY key. To resume playback, press the PLAY key again.

NOTE

To confirm the total playing time, use the PLAY TIME option in the SYSTEM sub-menu (see "Operation basics" on page 15)

Track selection

Using the skip function

Skipping track numbers backward or forward.

1. Select desired tracks for playback with the MULTI JOG dial on the front panel. Turning clockwise skips the track number backward and counter-clockwise skips forward.

Or, press the SKIP key on the remote control. Pressing ◀◀ key skips the track number backward and ▶▶ key skips forward.

2. Press the PLAY key to start playback.

Or, press the READY key to cue the track and enter playback standby mode after moving to the head of the selected track. To start playback, press the PLAY key.

4 – Playback operations

Selecting by track number

Using the number keys on the remote control, the number of the desired track can be entered directly. Even numbers with two or three digits can be entered easily. For example:

Track 9: press '9' and 009 will be displayed.

Track 12: press '1' and '2' and 012 will be displayed.

Track 103: press '1' and '0' and '3' and 103 will be displayed.

After input, press the **PLAY** key to start playback. Or, the **READY** key to cue the track at its head position and enter playback standby mode.

You can also enter the track number and start playback by pushing the **MULTI JOG** dial or using the **ENTER** key.

NOTE

This function cannot be used in Program or Random mode.

Track search

Normal search

Press the **◀▶** search key continuously on the front panel, or the **SEARCH** **◀▶** key on the remote control. To stop the search function, simply release the **◀▶** or the **SEARCH** key.

NOTE

The search function does not operate with MP3 discs.

Direct search

By specifying time from the start of a certain track, you can start playback from a specified point of a specified track.

■ Basic operation

During stop, play or playback standby modes, use the number keys on the remote control to input the three-digit track number (such as 002 for track 2), then the desired elapsed time (**min **sec) from the start of that track.

Example: To specify 1 min 30 sec from the start of track 2, input "002 001 30".

During input, the counter in the display will flash.

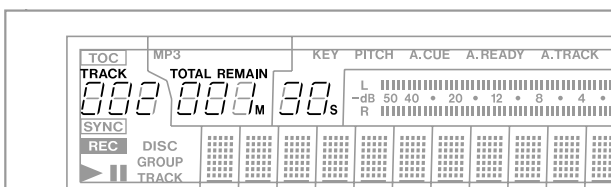

NOTE

Regardless of the time display mode (see "Time display switching on page 19), the time from the start of the specified track is displayed.

Pressing the **CLEAR** key cancels the input at any stage during input.

During stop or playback modes, when the final digit is entered, the desired position is automatically located and playback will begin from the desired point. During playback standby mode, at the desired point the unit will enter playback standby mode.

NOTE

If a point which does not exist is entered, Direct Search time entry mode will be cancelled.

The direct search function cannot be used in program or random mode.

For MP3 discs, time cannot be specified within a track. However, if you input the three-digit track number, playback will begin from the start of that track.

Operation variations

Even if the final "seconds" time value is not input, playback will begin from the selected "minutes" time after pressing the **ENTER** or **PLAY** key. Or, if you press the **READY** key, the unit will enter the playback standby mode at the selected point.

■ Specifying a track number only

After inputting the track number, press the **ENTER** or **PLAY** key to begin playback of that track, or the **READY** key to cue the track and enter playback standby mode.

NOTE

Instead of inputting the three-digit track number, you can input only the desired track number.

Example: To specify track 3, input only "3".

■ Specifying to the minute

After inputting the three-digit track number and the number of minutes after the start of the track, press the **ENTER** or **PLAY** key to begin playback of that track, or the **READY** key to cue the track and enter playback standby mode.

Example: To specify 1 min 00 sec from the start of track 2, input "002 001"

NOTE

Following the above example, if "0021" is input, the same position will be located.

4 – Playback operations

Playback modes

There are four different playback modes. The selected mode will be indicated on the left of the display.

- Continuous playback mode (default setting): no indication lamp
- Single playback mode: **SINGLE** is lit
- Program playback mode: **PROGRAM** red lamp is lit
- Random playback mode: **RANDOM** red lamp is lit

The playback mode can be selected using the **PLAY MODE** key on the remote control unit. Pressing the key changes the playback mode on the display in the following order:

Continue→Single→Program→Random

You can also select the playback mode using the **PLAY MODE** option in the **PLAY** sub-menu (see “Operation basics” on page 15). Turning the **MULTI JOG** dial clockwise

changes the playback mode shown on the display in the following order:

Mode>Cont→Mode>Single→Mode>Program→Mode>Random

Pressing the **MENU** key or pushing the **MULTI JOG** dial returns to normal mode from the menu mode.

While the mode can be changed from any playback mode, the explanation in this manual will assume the user is starting from the Continuous mode.

NOTE

The selected playback mode remains after power is turned off. However, the program playback mode will be cleared to “Continuous” mode when the power is turned off.

Continuous playback

Programing is cancelled, and playback continues in the normal order.

1. When stopped, set the mode to display **Continue** or **Mode>Cont**.

2. Press the **PLAY** key to begin playback in order of the track number.

Single-track playback

This function enables playback of just a single track.

1. When stopped, set the mode to display **Single** or **Mode>Single**.
2. Use the **SKIP** key or the number keys (0~9) on the

remote control to select the desired track. The **MULTI JOG** dial can be used to select the track also.

3. Press the **PLAY** key to begin playback.
After the selected track finishes, playback stops.

Random playback

In this mode, the unit will play back all the tracks on the disc in completely random order, regardless of track number.

When stopped, set the mode to display **Program** or **Mode>Random**. Press the **PLAY** key and random playback will begin.

NOTE

Even when the power is turned off, the unit will remain in Random mode.

Program playback

This function enables playback of selected tracks in any desired order. Up to 99 tracks can be selected for program playback.

1. When stopped, set the mode to display **Program** or **Mode>Program**.
2. Use the number keys (0~9) on the remote control unit to select each desired track for program playback, then press the **ENTER** key.

You can also rotate the **MULTI JOG** dial to select the track number and push to enter.

The track number will be entered into the program.

Repeat the above step 2 until the desired program is completed. As the program is being created, the program number and total program playing time is revised on the display.

NOTE

*If the **CLEAR** key is pressed, the programmed track will be deleted from the last.*

3. When program setting is completed, press the **PLAY** key to begin playback of the tracks in the programmed order.

NOTE

*If the **STOP** key is pressed without first pressing the **PLAY** key, all the program data will be erased.*

4 – Playback operations

When stopped, if the playback mode is switched to another, all the program data will be erased.

The programmed play order is not memorized when power is turned off.

In this mode, if there are no tracks programmed, the CD-RW900SL will not start playback.

If an attempt is made to enter more than 100 program steps, the message **PGM Full!** appears on the display.

If the total program playing time exceeds 999 min 59 sec, --- : -- appears on the display.

Time display switching

When the TIME key on the front panel or the remote control is pressed, the time display will switch through several modes on the display.

- Elapsed track time (no display light indication)
- Remaining track time (**REMAIN** is lit in the display)
- Elapsed disc time (**TOTAL** is lit in the display)
- Remaining disc time (**TOTAL** and **REMAIN** are lit in the display)

When stopped, the total recording time is shown, regardless of the status of the **TOTAL** and **REMAIN** indicators.

NOTE

In program mode, pressing the TIME key displays the elapsed and the remaining time of the whole program.

When playing an MP3 disc, elapsed track time is always displayed, and the TIME key cannot be used.

For details on time display during recording, please refer to "Time display while recording" on page 24.

Even when power is turned off, the time display mode setting is retained.

Timer playback

By using an external timer, you can set the CD-RW900SL to play the loaded disc automatically when the unit is turned on by the timer.

1. First, plug the power cord of the CD-RW900SL into the power outlet of the timer.
2. Load a disc into the unit.
3. Switch the TIMER switch on PLAY to enable timer function on for the desired deck.

When Timer playback has been turned on, the timer icon lights up in the display.

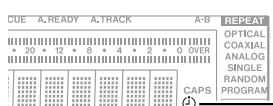

Timer indicator

NOTE

The indicator flashes when a disc is not loaded into the unit.

4. Set the timer to the desired time. Consult the timer's operation manual for details. At the set time, the power to the CD-RW900SL will be turned on, and playback will automatically begin.

Repeat playback

1. Press the REPEAT key to turn on the repeat mode.

In this mode, all the tracks on the disc are played continuously. The display shows **Repeat ON** and the indicator lights up **REPEAT**.

During playback, if the repeat mode is turned on, playback continues as before, and when the last track finishes, playback resumes from the first track.

If the repeat mode is turned on when the deck is stopped, press the PLAY key to begin operation.

2. Press the REPEAT key again to turn off repeat mode. **Repeat OFF** appears then the REPEAT indicator turns off.

NOTE

Combining the repeat mode with the program, Single-track playback and Random playback functions will enable Program repeat, Single-track repeat and Random repeat operations, respectively.

Settings for the repeat playback mode remain after power is turned off, except the specified A-B section (see "A to B repeat playback" on page 20).

4 – Playback operations

A to B repeat playback

If a specific portion between two points on the disc is specified, that portion can be played back repeatedly.

1. During playback, press the A-B key on the remote control at the beginning of the desired portion on the disc.

The REPEAT indicator lights up in the display and the A- indicator will flash.

2. At the end of the desired portion on the disc, press the A-B key again.

Then, the REPEAT and A-B indicators light up in the display, and the desired A-B section will be played back repeatedly.

NOTE

You can also operate this function during playback standby.

3. To cancel the A-B repeat mode and resume normal playback, press the A-B key once again.

The REPEAT and A-B indicators will turn off.

NOTE

A-B repeat cannot be used when the specified A-B section spans more than one track, and cannot be used with MP3 discs.

When the STOP key is pressed, the specified A-B section is cancelled.

Auto Cue function

Using the auto cue function, you can select a cue point where sound begins (not where a track begins) within a track.

Turn the auto cue function on and use the A_CUE LEVEL sub-menu option (see “Operation basics” on page 15) to set the sound detection level (-24, -30, -36, -42, -48, -54, -60, -66 and -72 dB).

Then, select a track and press the PLAY key. The unit enters playback ready mode.

When the PLAY key is pressed again, playback begins at exactly the cue point.

While the auto function is on, the A.CUE indicator lights up on the display.

Auto Ready function

This function allows the playing back a single track, and the automatic cueing of the next track ready for playback.

Use the A_READY sub-menu option to turn the function on or off. When on, the A.READY indicator lights up on the display.

Combined with Auto Cue function, the unit enters playback ready mode at the point where the sound detection level is set in A_CUE LEVEL sub-menu option of the next track.

Pitch control function

When playing back an audio CD, the pitch (or speed) of the playback can be varied. Pitch can be varied +/- 16%.

1. When stopped, press the PITCH key on the remote control to turn on the Pitch control function.

Or, use the PITCH option in the PLAY sub-menu (refer to “Operation basics” on page 15).

The current pitch value appears on the display for seconds and the PITCH indicator will light up.

2. Press the MENU key and select the PITCH CONT option in the PLAY sub-menu to set the desired value and push the MULTI JOG dial to enter.

PitchXXX will appear on the display.

Then, rotate the MULTI JOG dial to set the desired value.

NOTE

Use the PITCH STEP option in the PLAY sub-menu to adjust the pitch value steps from 0.1% to 1.0% in 0.1%

increments (default: 0.1%).

3. Press the MENU key or push the MULTI JOG dial to enter and return to normal mode.

During playback, the pitch control playback can be disabled temporarily. Press the PITCH key on the remote control or use the PITCH option in the PLAY sub-menu to turn the function off.

Pitch>OFF appears on the display and the pitch control playback will be off temporarily, until the function is re-set again.

To resume the pitch control playback, press the PITCH key again or use the PITCH option.

NOTE

When turning the pitch control on and off during playback, sound output is cut for a short instant.

Pitch control cannot be used with MP3 discs.

4 – Playback operations

Key control function

The key of the music can be changed during stop, playback or playback standby modes. However, please note that this feature does not work with MP3 discs.

1. Press the MENU key to select the KEY option in the PLAY sub-menu (see “Operation basics” on page 15) to enter the function.

Or, press the KEY key on the remote control to set the function on.

The KEY indicator will light up.

2. Use the KEY LEVEL option in the PLAY sub-menu to adjust the playback key level.

The playback key can be raised or lowered 1/2 octave in half-tone increments. Selection values: 0 (no change), ♭1 to ♮6, #1 to #6.

3. Rotate the MULTI JOG dial to select the desired key level and push to enter.

NOTE

In this condition, when a CD is played back, the key of the music is changed while the speed of the music remains the same.

Even when the power is turned off, the key change setting is retained.

When the Key control function is on, even if the Pitch control function is used to change the playback speed, the key of playback will remain fixed at the preset key {even if the key level is 0 (zero)}, the Key control function can be turned on.

When using the key control function, the volume of the playback sound may occasionally sound like it is vibrating. This is a result of the key control algorithm working on the CD playback sound and is normal.

Playing back MP3 files

MP3 files recorded onto a CD are handled the same way as files are handled in an ordinary PC, with some MP3 files held within a directory. In addition, several directories can be combined into one directory. This results in multiple layers of directories and files.

When the Directory mode is on, only those files within a selected directory are available for playback.

When the directory mode is off, the directory configuration is ignored, and all MP3 files recorded on the disc are available for playback. Please note that Program playback and Repeat playback only function within directories.

NOTE

Each MP3 file is handled as a track.

Directories that do not contain MP3 files directly under them cannot be selected for playback. For example, in the diagram below, under directory A are directory B and directory C. If there are MP3 files in both directories B and C, directory A cannot be selected for playback, but directory B and C can be selected for playback.

The CD-RW900SL can play back MP3 files recorded in formats that conform to ISO9660 level 1, level 2, and the Joliet extensions. Discs recorded in multiple sessions may also be played back.

CDs containing MP3s to be played by the CD-RW900SL, have their contents must be within the following maximum limits:

- Number of directories: 255
- Number of hierarchical structures: 8
- Number of MP3 files: 999
- Title size of MP3 files and directories: 255

MP3 files are played in the following order

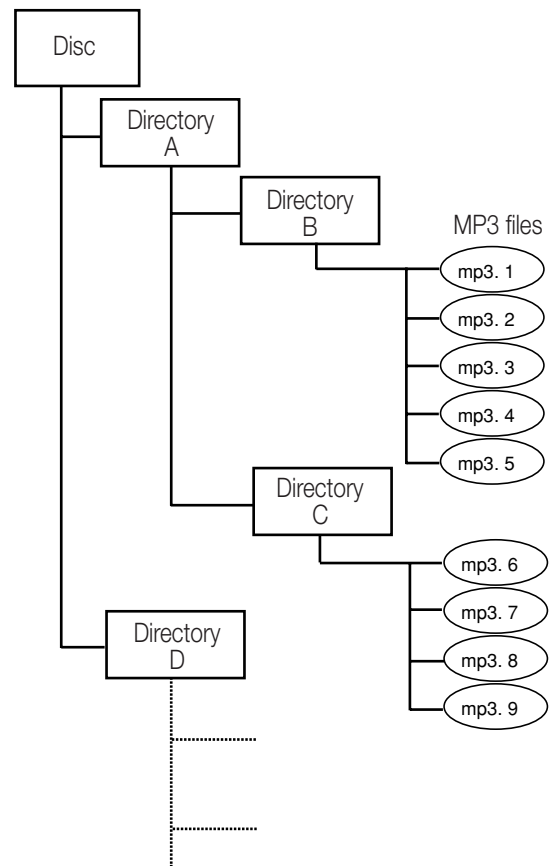

In this manner, playback proceeds from the top level directories.

4 – Playback operations

About MP3 track data

During playback, titles are displayed in the following order of priority:

ID3v2 > ID3v1 > file title

When stopped, the file title is displayed.

Directory playback setting

1. Press the DIRECTORY key on the remote control.

Or, use the DIRECTORY option in the PLAY sub-menu to turn this mode on or off (see “Operation basics” on page 15).

Pressing the MENU key or pushing the MULTI JOG dial exits to normal mode.

NOTE

All MP3 files in a disc can be played back when directory playback mode is off. The indicator MP3 lights up and only the total number of track will be shown.

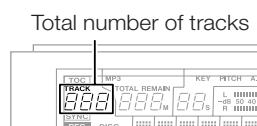

3. Press the PLAY key to start playback in the directory.

Program or Repeat playback can be operated in the selected directory also.

NOTE

MP3 file formatted at 44,1 kHz sampling rate and 128 kbps or higher are required, otherwise, that MP3 file cannot be played back.

2. When stopped, use the MULTI JOG dial or SKIP key to select desired directory for playback.

MP3 action setting

You can choose whether the unit continues playback or stop when MP3 playback fails (Decode Err!).

Select “MP3 ACTION?” sub-menu on the PLAY option. Select “Skip” or “Stop.”

Skip

When MP3 playback fails, the unit skips the current track and advances to the next track. Playback will stop if the current track is the last track (i.e., if the repeat function is off and the current track is the last track on the disc or in the program). The display shows Decode Err!.

Stop

When MP3 playback fails, the unit stops playback. The display shows Decode Err!.

Before you start recording using the CD-RW900SL, make sure that you understand the following key points:

- Once you have recorded on a CD-R disc, the data cannot be erased from it.

- You can add tracks to an unfinalized recordable disc. Once finalized, a CD-R disc is “fixed” and behaves in the same way as a pre-recorded disc. Finalized CD-RW discs, however, can be erased, refreshed and re-recorded.

Input selection

To select the input to be recorded, press the **INPUT SELECT** key on the main unit.

Repeated presses of the key cycle through the following options:

ANALOG	Analog
OPTICAL	Optical digital in
COAXIAL	Coaxial digital in

In the case of either the coaxial or optical inputs being selected, the indicator **COAXIAL** or **OPTICAL** lights up.

If the analog signal is selected, the **ANALOG** indicator lights on the right of the screen.

Analog recording level:

The level of the analog signals received at the **ANALOG IN** jacks are controlled with the **INPUT** controls.

When recording analog signals, set the digital volume to 0 dB.

Digital recording level:

The level of the digital signal may be controlled using the digital volume menu, as described below.

1. Call up the **VOLUME** option in the **REC** sub-menu (see “Operation basics” on page 15).

Push the **MULTI JOG** dial to enter the function on.

2. Rotate the **MULTI JOG** dial to adjust the input volume between **-54dB** and **+18 dB** (relative to the original input level).

There is also a **-∞** setting which represents a complete signal cut. The display shows **Vol1> ---dB** for the **-∞** setting.

3. Press the **MENU** key or push the **MULTI JOG** dial to enter the setting and return to normal mode.

Input monitoring

When the unit is in record ready, or record mode, the input signal is output from the **OUT** jacks (digital and analog), allowing you to hear the input signal.

Press the **RECORD** key on the front panel or the remote control when a recordable disc is not inserted.

The word **Monitor** appears on the display to show that the output signal is an echo of the input signal(s).

Exit the monitor mode by using the **STOP** key.

Frequency conversion

The sampling frequency for CDs is 44.1 kHz. The CD-RW900SL will always record (and play back) CDs at this frequency.

However, if recording through a digital connection (coaxial or optical) and the source has been recorded at a frequency other than 44.1 kHz, or is being played back at a non-standard speed using a varispeed unit (more than 1% away from the standard), the CD-RW900SL’s internal frequency converter: SRC (Sampling Rate Converter) will automatically convert the incoming frequency to 44.1 kHz.

NOTE

When the SRC function is off, and a digital signal is received, the display shows the REC indicator flashing while recording or when in recording standby mode.

*The digital signals other than 44.1kHz cannot be recorded when SRC is off. The error message **Not F=44.1k!** will appear on the display.*

To enable the SRC

Press the **MENU** key and select the **SRC?** option in the **REC** sub-menu (see “Operation basics” on page 15). Rotate the **MULTI JOG** dial to select **ON**. Press the **MENU** key or push the **MULTI JOG** dial to enter.

5 – Recording

Basic recording

1. Load a recordable disc into the unit. As the disc loaded, the display shows `TOC Reading`, with the period flashing.
2. Press the INPUT SELECT key to select a recording source (see “Input selection” on page 23).

If a digital source is selected, and the connection or the signal are improper, the error message `D-IN UNLOCK!` will appear on the display.

3. Press the RECORD key. The unit enters record ready mode, as shown by the **REC** and **READY** indicators on the display.

NOTE

As the unit enters record ready mode, the display shows `Now OPC` (Optimum Power Control) occasionally, as the unit prepares to record on the disc.

To adjust the level of the source, following the guidelines in “Input selection” on page 23.

NOTE

The red “OVER” indicators on the meters should never light. Unlike analog equipment, digital audio units produce extremely unpleasant sounds when distorted, and there is no “headroom” after the 0 mark. If recording digitally from a commercially-produced CD, the volume set in the menu should be 0 dB. This will maintain all the dynamic range of the source CD without clipping. Only boost the signal if the source is exceptionally quiet.

An analog signal input at nominal level, with no cut or boost from the volume controls, is equivalent to a reading of -16 dB on the meters.

4. Press the PLAY key to start recording.

Pressing the READY key stands by recording temporarily. To restart recording, press the READY key or PLAY key again.

5. Press the STOP key to stop recording.

When recording stops, the display shows `PMA Writing` (Program Memory Area) flashing for a few seconds as the unit writes to the disc.

NOTE

When PMA Writing is shown on the display, all keys are ignored.

To confirm the total recording time, use the **REC TIME** option in the **SYSTEM** sub-menu (see “Operation basics” on page 15).

NOTE

Do not vibrate the unit or turn off the power when the unit writes to the disc, otherwise, recording will fail.

Time display while recording

When in record or record ready mode, repeated presses of the **TIME** key cycle through four different time modes:

- Elapsed track time (no display light indication)
- Remaining track time (**REMAIN** is lit in the display)
- Elapsed disc time (**TOTAL** is lit in the display)
- Remaining disc time (**TOTAL** and **REMAIN** are lit in the display)

Full disc

If the disc becomes full during recording, the unit will automatically insert a fade-out. For example: When recording a long program, just before the end of the disc is reached, the unit starts a fade-out over four seconds and the display will show **Fade Out**.

When the fade-out has finished, the display shows `Disc Full!`. Press the **STOP** key to exit.

If the disc is a CD-RW, the final track can be erased, if required (see “Erasing” on page 29) and the disc then finalized. If the disc is a CD-R, it must be finalized prior to use (see “Finalizing” on page 28).

Advanced recording

Fade-in and fade-out recording

At the beginning and end of recording, fade-in and fade-out effects can be performed.

1. When stopped or when in recording standby mode, set the operation using the following menu options on the REC sub-menu (see “Operation basics” on page 15).

FADE IN?

The length of the fade in to the normal level can be set between 1 and 30 seconds in 1-second increments (default setting: 3 seconds).

FADE OUT?

The length of the fade out into complete silence can be set between 1 and 30 seconds in 1-second increments (default setting: 3 seconds).

The display shows Fade Out $\times\times\times$ s or Fade In $\times\times\times$ s.

2. In recording standby mode, press the FADER key on the remote control.
Recording begins and the sound fades in. After the preset fade-in time, the sound is at normal level.
3. During recording, press the FADER key on the remote control when you wish to fade-out the sound.
Fade-out begins with Fade Out flashing on the display then the unit enters recording standby mode.
4. Press the STOP key and the PMA writing will begin.

NOTE

Fade-in or fade-out function can be operated only by pressing the FADER key on the remote control unit.

Synchronized recording

Synchronized recording basically means that recording will begin automatically when a signal is received, and will stop when the signal ends.

The **SYNC** indicator appears on the display.

Starting playback of the source automatically starts recording on the CD-RW900SL if Sync function is on (see “Sync recording” below) and manual record start is disabled.

Sync recording

1. While recording standby mode, press the SYNC REC key.
2. Set the signal detection threshold level. Use the SYNC LEVEL option in the REC sub-menu (see “Operation basics” on page 15).

Rotate the MULTI JOG dial to adjust the level. The level can be set from -72 dB to -24 dB in 6 dB increments. The default setting is -54 dB.

Press the MENU key or push the MULTI JOG dial to enter and return to recording standby mode.

3. Input the source signal.

Recording begins automatically when the source signal is detected. The source signal should be higher than the adjusted threshold level.

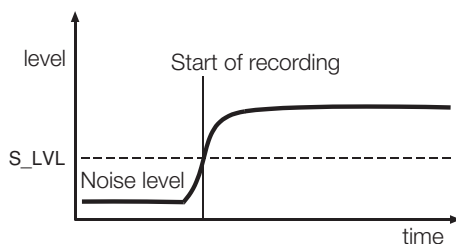

NOTE

After SYNC is set, over one second of silence which is under the adjusted threshold level is required to start

recording automatically. Otherwise, the unit does not begin recording even if it is detecting a signal.

When audio signal is not detected for more than five seconds, the CD-RW900SL automatically will stop recording and enter record standby mode.

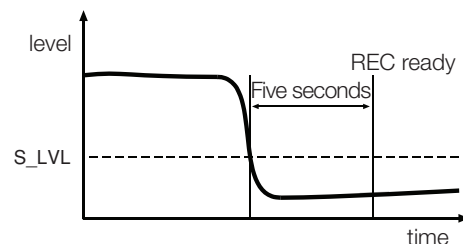

NOTE

When the input level drops below the adjusted threshold level for more than five seconds, recording stops automatically and enters in recording ready mode.

3. To cancel the Sync recording mode, press the SYNC REC key. Recording returns to normal and continues till you press the STOP key or the source signal stops.

Pressing the STOP key stops recording.

The setting remains when the function is set on again.

5 – Recording

NOTE

If you set the value so that only high-level signals trigger recording, remember that the start of a piece may not be recorded as in the diagram.

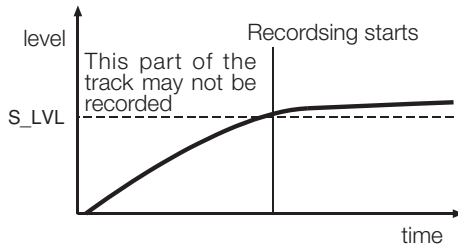

Also remember that when recording from an analog source, the threshold should be set so that it is higher than the "noise floor". If the "noise floor" is higher than the threshold, a false start will occur:

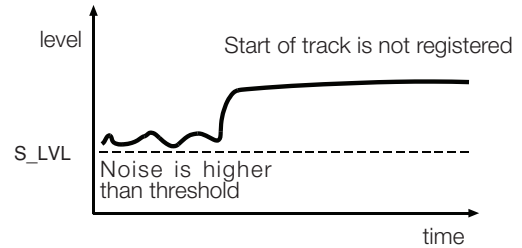

Automatic track division

The trigger level can also be used to divide tracks if the A_TRACK (auto track) function is enabled.

When this function is enabled, the unit automatically inserts a track division in the recorded material.

■ To enable or disable automatic track division:

1. Use A_TRK option in the REC sub-menu to set the mode on. The A.TRACK indicator at the top right of the display lights.
2. Rotate and push the MULTI JOG dial to select and enter the modes following:

DD (digital direct)

When recording digitally from MD, CD or DAT, this mode detects a track boundary and divides the track. However, when the DD mode is on, and if the analog source or non-DAT/CD/MD digital connections are detected, the track number will be incremented using level detection, as set with the A_TRK LEVEL setting as described here.

Level

When the sound level has dropped below the threshold for more than two seconds, and sound has re-started, the track will be divided.

Use A_TRK LEVEL option in the REC sub-menu. The trigger level is set to -24dB to -72 dB.

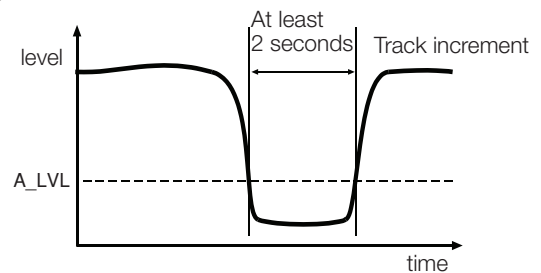

Manually divide track

While recording is taking place, press the RECORD key. The current track number is incremented by one.

For details of automatic track division while recording, see "Automatic track division" on page 26.

NOTE

According to the "Red Book" (the specification for audio CDs), a track cannot be less than four seconds in length, and there can be a maximum of 99 tracks on an audio CD. Bear these limitations in mind when adding track divisions.

This operation can not be applied while recording track 99.

Rec mute function

The Rec mute function allows instant cut-off of the input signal, and records four seconds of silence on the disc.

While recording is in progress, press the **REC MUTE** key on the remote control.

The display shows the **RecMute** flashing, the meters stop displaying the current level and the monitored sound is cut.

After about four seconds, the unit enters record ready mode.

NOTE

This function is only available from the remote control unit.

Restricting the number of tracks

When making a recording, it is possible to restrict the number of tracks that may be recorded at one time.

At any time within record or record ready mode, turn the **MULTI JOG** dial to display the track numbers you want to record.

The maximum number that can be entered is 99 tracks.

6 – After recording

This section deals with the actions taken after recording: finalizing for CD-R and CD-RW discs, and erase operations for CD-RW discs.

Once finalized, CD-R discs are truly final—no more can be recorded on them. By contrast, CD-RW discs can be “unfinalized” using the CD-RW900SL, i.e. their TOC can be deleted, and if there is space, further material can be

recorded on them. Even if the disc is full, tracks can be erased following the unfinalize process, and new material can be recorded.

Finalizing

As has been explained earlier (“About Finalizing” on page 7), in order for a disc to become a standard CD, it must have a Table of Contents (TOC) written to it. This process is known as finalizing.

An unfinalized disc can always be distinguished on the CD-RW900SL by the **TOC** indicator under the disc type on the display being unlit when the disc is inserted.

To finalize a disc:

1. **Load the unfinalized disc, and with the unit in stop mode, press the FINALIZE key.**

The display shows **FINALIZE?**

If you do not want to proceed with the finalizing process, press the **FINALIZE/INS** key on the front panel or the **FINALIZE** key on the remote control.

2. **To start the finalizing process, push the MULTI JOG dial or press the ENTER key on the remote control.**

The display shows **Sure?**

If you do not want to proceed with the finalizing process, press the **STOP** key.

3. **When finalization has been chosen, the display shows the TOC flashing and the remaining time. The unit starts counting down from a time shown on the display.**
4. **When finalization has been finished successfully, Complete appears and the TOC will be lit on the display.**

NOTE

During the finalizing process, all key presses are ignored.

Unfinalizing CD-RW discs

If a CD-RW disc has been finalized, it is possible to erase the Table of Contents in the following way:

1. **With the finalized disc loaded and the unit in stop mode, press the ERASE/DEL key on the front panel or the ERASE key on the remote control.**

Rotate the **MULTI JOG** dial or press the **SKIP** key on the remote control to select **UNFINALIZE?**. Push the **MULTI JOG** dial or press the **ENTER** key to confirm.

If you do not want to proceed with the unfinalizing process, press the **ERASE/DEL** key on the front panel or the **SKIP** key on the remote control.

2. The display shows **Sure?**

If you do not want to proceed with the unfinalizing process, press the **STOP** key.

3. **To start the unfinalizing process, press the MULTI JOG dial or the ENTER key again.**

When unfinalization has been chosen, the display shows **Erase** flashing and the remaining time. The unit starts counting down from a time shown on the display.
4. **When finalization has been finished successfully, Complete appears on the display, and the TOC indicator will go off.**

Erasing

Erasing tracks

This operation erases the specified track and all sub-sequent tracks from a recorded CD-RW disc.

NOTE

Once this operation has started, the STOP key cannot be used to cancel it. Please check the track range to be deleted first.

Erasing track is operated only when unit is in continuous playback.

1. While stopped, press the ERASE/DEL key on the front panel or the ERASE key on the remote control. Select the ERASE TRACK? rotating the MULTI JOG dial or pressing the SKIP key on the remote control.

To cancel the operation at this point, press the ERASE/DEL or the ERASE key again.

2. Push the MULTI JOG dial or press the ENTER key to enter the function.

The display shows Erase XX-XX (the number of

the first track and last track to be erased).

Rotate the MULTI JOG dial or press the SKIP key to change the track numbers you desire to erase.

To cancel the operation at this point, press the ERASE/DEL or the ERASE key again.

3. Push the MULTI JOG dial or press the ENTER key to operate the function.

The display shows Sure?

To cancel the operation at this point, press the STOP key.

4. Push the MULTI JOG dial or press the ENTER key again to proceed the operation.

The display shows Erase flashing and the remaining time. The unit starts counting down from a time shown on the display.

5. When the tracks have been erased, Complete will appear on the display.

Erasing a whole disc

When you want to erase a whole disc (all the tracks on a disc), follow the procedure below:

NOTE

Once the operation is proceeded, the STOP key cannot function. Please confirm before the operation.

1. While stopped, press the ERASE/DEL key on the front panel or the ERASE key on the remote control. Select the ERASE DISC? by rotating the MULTI JOG dial or pressing the SKIP key on the remote control.

To cancel the operation at this point, press the ERASE/DEL or the ERASE key again.

2. Push the MULTI JOG dial or press the ENTER key to enter the function. The display shows Sure?

To cancel the operation at this point, press the STOP key.

3. Push the MULTI JOG dial or press the ENTER key again to proceed the operation.

The display shows Erase flashing and the remaining time. The unit starts counting down from a time shown on the display.

4. When the disc has been erased, Complete appears then Blank Disc will appear on the display.

Refreshing a disc

Refreshing the disc makes a disc usable again. This operation destroys all data on the disc.

1. Load the disc, and the unit in stop mode, press the ERASE/DEL key on the front panel or the ERASE key on the remote control. Select the REFRESH? rotating the MULTI JOG dial or pressing the SKIP key on the remote control.

To cancel the operation at this point, press the ERASE/DEL or the ERASE key again.

2. Push the MULTI JOG dial or press the ENTER key on the remote control to enter the function. The display shows Sure?

To cancel the operation at this point, press the STOP key.

3. Push the MULTI JOG dial or press the ENTER key again to proceed the operation.

The display shows Erase flashing and the remaining time. The unit starts counting down from a time shown on the display.

4. When the disc has been refreshed, Complete appears then Blank Disc will appear on the display.

7 – Titling

Titles can be given to the disc and the tracks on the disc, using the TEXT EDIT option on the TEXT sub-menu.

NOTE

After a new title is selected and entered on the disc, TOC will light up on the display. If the power is turned off, the TOC has not been recorded on the disc and

the titles will not have been added. You must finalize the disc to save the titles.

Title input operation

Follow the guidelines below to input titles on the screen. Operate them when in the text edit mode.

It is more efficient to connect a keyboard for title input (see “Title input by keyboard” on page 31).

Select the type of character for input

Press the DISPLAY key on the unit or the remote control to select from two different types of characters.

Lower case letters/code: no indication

Capital letters/code: CAPS

Input procedure

Rotate the MULTI JOG dial or the SKIP key on the remote control to get the desired characters on the display.

Push the MULTI JOG dial or press the ENTER key on the remote control to enter.

To move the cursor position

Use the ◀◀/◀ key and the ▶▶/▶ key on the front panel, or the SEARCH key on the remote control.

To delete characters

Place the cursor on the character, then press the ERASE/DEL key on the front panel, or the ERASE key on the remote control.

To insert characters

Move the cursor to the location where you wish to insert a character, and press the FINALIZE/INS key on the front panel or the FINALIZE key on the remote control.

To change a character

Place the cursor on the character to be changed, then input the desired character.

NOTE

As with the TEXT menu, if you attempt to eject the disc without writing the TOC to the disc, the display will show Sure? Text!. If you want to eject the disc without performing a TOC write, press the EJECT key while “Sure Text!” is shown on the display. The text that have been edited or entered will be abandoned.

The disc or track title on a finalized disc cannot be edited. Unfinalizing (CD-RW only) is needed in this case to use the title input function.

Disc title input

1. While stopped, select the TEXT EDIT option in the TEXT sub-menu (see “Operation basic” on page 15). Text> Disc will appear.

2. Press the MULTI JOG dial or the ENTER key on the remote control.

Now, you can input or edit the disc title following the guidelines above.

3. Press the MENU key to enter.

If you want to cancel, press the STOP key.

Track title input

1. While stopped, select the TEXT EDIT option in the TEXT sub-menu (see “Operation basic” on page 15).

2. Rotate the MULTI JOG dial or repeatedly press the SKIP keys on the remote control to select the track number you wish to title.

3. Push the MULTI JOG dial or press the ENTER key on the remote control.

Now, you can input or edit the track title following the guidelines above.

4. Press the MENU key to enter.

If you want to cancel, press the STOP key.

Using a keyboard with the CD-RW900SL

A computer keyboard can be connected to the IBM PC compatible PS/2 interface on the front panel to operate

certain functions of the CD-RW900SL. It is particularly efficient for title input.

Keyboard type setting

The CD-RW900SL must be set for the type of keyboard being connected.

Set the type using the sub-menu **KEYBOARD** option on the **SYSTEM** sub-menu. Select **US** for an English-language keyboard, or **JP** for a Japanese-language keyboard.

Title input by keyboard

Titles can be input just like typing on a PC.

To enter the Title Edit menu

Press **SHIFT + F8** to enter the Disc/Track Title Edit Menu.

To select the type of characters for input

Press **CAPS** to select or cancel upper case letters

To input characters

Character input is performed directly with the letter and number keys.

To move the cursor

Use the cursor arrow keys

To delete characters

Delete key: deletes the character in the cursor position

Back space key: deletes the character before the cursor position

To insert a character

Use the Insert key.

To change a character

Put the cursor on its position and input the desired character.

Other keyboard operations

The keyboard can be used not only for title input, but also to control the deck transports, perform editing functions

Keyboard key	Operation
F1	same as pressing the ◀◀ key
F2	same as pressing the ▶▶ key
F3	same as pressing the Key key
F4	same as pressing the STOP key
F5	same as pressing the PLAY key
F6	same as pressing the READY key
F7	set the Auto Cue on or off
F8	same as pressing the RECORD key
F9	set the Auto Ready on or off
F10	same as pressing the REPEAT key
F11	same as pressing the P.MODE key
F12	same as pressing the PITCH key
SHIFT + F1	direct to "ERASE TRACK?"
SHIFT + F2	direct to "ERASE DISC?"
SHIFT + F3	direct to "REFRESH?"
SHIFT + F4	
SHIFT + F5	
SHIFT + F6	
SHIFT + F7	
SHIFT + F8	direct to "TEXT EDIT?"
SHIFT + F9	
SHIFT + 10	

and other operations. The list below shows the keys that perform various operations.

Keyboard key	Operation
SHIFT + F11	direct to "UNFINALIZE?"
SHIFT + F12	direct to "FINALIZE?"
CTRL + F1	Direct track search TRACK 1
CTRL + F2	Direct track search TRACK 2
CTRL + F3	Direct track search TRACK 3
CTRL + F4	Direct track search TRACK 4
CTRL + F5	Direct track search TRACK 5
CTRL + F6	Direct track search TRACK 6
CTRL + F7	Direct track search TRACK 7
CTRL + F8	Direct track search TRACK 8
CTRL + F9	Direct track search TRACK 9
CTRL + F10	Direct track search TRACK 10
CTRL + F11	Direct track search TRACK 11
CTRL + F12	Direct track search TRACK 12
CAPS	select or cancel upper case letters
←/→	to move the cursor
Delete	same as the DEL or CLEAR key
Back space	deletes the character before the cursor
Insert	same as the FINALIZE/INS key
ESC	cancel edit or title edit and finis Menu mode
Enter	same as the ENTER key

8 – Reference and specifications

Error messages

Message	Details / response
Can't Rec!	Cannot record. Either erase the contents of the disc (for a CD-RW), or use a different recordable disc.
Disc Error!	The disc has malfunctioned. Please replace with a new disc.
Disc Full!	No recording time remaining, or no recordable track is left on the disc.
Text Full!	No space to input the letters.
Sure? Text!	The text data is not written on the disc yet. Eject the disc to cancel the text you entered or perform the finalize operation to write the data to the disc.
Drive Error!	There is a problem in the drive.
D-IN UNLOCK!	The digital input is not connected. Turn on the power of the equipment connected to DIGITAL IN.
Not Audio!	There is no audio signal from DIGITAL IN.
Erase Error!	An error occurred while erasing.
Not Fs44.1k!	The sampling frequency of the digital input is not 44.1 kHz. Please turn the SRC on.
PGM Empty!	There is no program.
PGM Full!	No new programs can be created.
Can't Edit!	Editing cannot be performed due to operational restrictions.
Can't Sell!	Menu selection cannot be performed due to selection restrictions.
Rec Error!	There was an error during recording. Please re-record.
OPC Error!	There was an error during OPC. Please re-record.
No DIR!	There is no directory that contains a file.
Decode Err!	The MP3 file cannot be played back.
Format Err!	The disc is in a format that the CD-RW900SL cannot read.
IR Disable!	Remote control operation is not allowed.

Messages during operations

Message	Statement
Blank Disc	A blank recordable disc has been inserted.
Complete	An operation such as finalize or erase has been successfully completed.
Now OPC*	Calibration is being performed to operate recording properly.
Disc Repair	The disc is being repaired, and this operation will take a long time. Please do not turn off the power of the CD-RW900SL until it finishes.
PMA Writing*	The recorded content is being written to the disc.
TOC Reading	The table of contents data is being read.

*OPC=Optimum power Control

*PMA=Program memory Area

8 – Reference and specifications

Troubleshooting

Symptom	Possible cause and remedy
There is no power to the unit.	Please check the power cord is properly plugged in.
“Disc Error!”, or “OPC Error!” is displayed.	The disc may be dirty. Please replace the disc.
Playback is not possible.	This may be due to condensation. In this case, remove the disc, turn the power on and wait a few hours, then try again.
No sound is output.	<ul style="list-style-type: none">• Confirm the connections with the audio system.• Check the volume level, and proper amplifier operation.
Recording is not possible.	<ul style="list-style-type: none">• Confirm the connections with the audio system.• Adjust the recording level.• The disc may be for playback only. Please replace with a recordable disc.
Noise or static can be heard.	Please re-position the unit away from strong source of magnetism such as a television.
The unit does not retain settings.	While settings are retained each time they are made, in some case they will not be retained when the power is turned off too soon. To prevent this from happening, do not turn off the power right after making a setting.
Can't insert a disc.	Take the disc out and press the EJECT key to reset. Then try again. Never use force to insert the disc into the slot.

8 – Reference and specifications

Specifications

Recordable discs	CD-R, CD-R-DA, CD-RW, CD-RW-DA (High speed CD-RW is supported)
Quantization bit depth	16 bit
Sampling frequency	44.1 kHz
Frequency response	20 Hz~20 KHz ±0.8 dB (playback) ±1.0 dB (recording)
S/N	95 dB (playback) 90 dB (recording)
Dynamic range	95 dB (playback) 90 dB (recording)
Distortion	0.006 % (playback) 0.008 % (recording)
Channel separation	90 dB (playback) 80 dB (recording)
Wow and flutter	< 0.001 % (unmeasurable)
Analog inputs	Unbalanced RCA pin Level -10 dBV ±2 dB (Full Scale -16 dB) Minimum input level -19 dBV (adjustable level at Full Scale -16 dB) Input impedance 22 K Ω ±10% (unbalanced)
Analog outputs	Unbalanced RCA pin Level -10 dBV ±2 dB (Full Scale -16 dB) Maximum output level +6 dBV ±2 dB Output impedance 600 Ω ±10% (unbalanced)
Phones output	Stereo (6.3 ϕ) 20 mW 32 Ω
Digital input	Coaxial RCA pin jack (IEC-60958 Consumer use) Optical TOSLINK (IEC-60958 Consumer use)
Digital output	Coaxial RCA pin jack (IEC-60958 Consumer use) Optical TOSLINK (IEC-60958 Consumer use)
Keyboard	Mini DIN 6 pin
Power	U.S.A./Canada 120 VAC, 60Hz U.K./Europe 230 VAC, 50Hz Australia 240 VAC, 50Hz
Power consumption	16 W (U.S.A./Canada) 18 W (U.K./Europe/Australia)
Dimensions (d x w x h)	307.6 x 482.6 x 94 (mm) / 12.1 x 19.0 x 3.7 (in)
Weight	4.5 kg (10 lb)

8 – Reference and specifications

Dimensional drawing

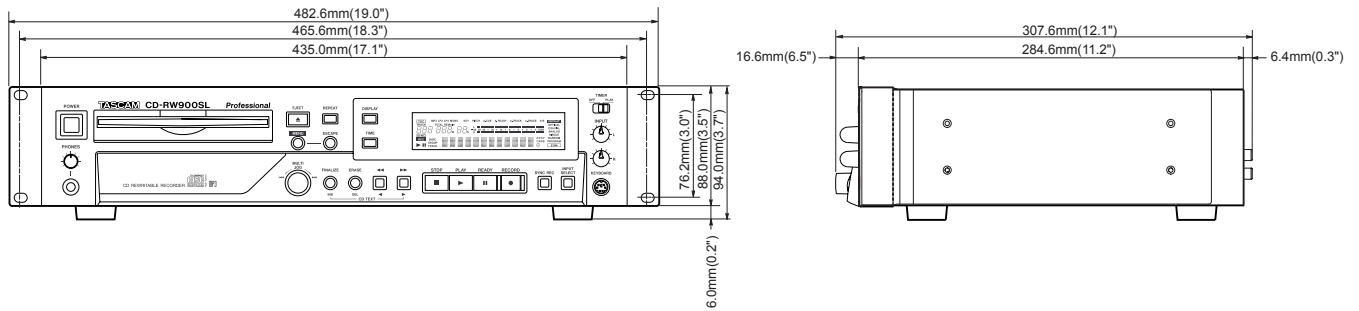

TASCAM
TEAC Professional Division

CD-RW900SL

TEAC CORPORATION

Phone: +81-422-52-5082

3-7-3, Nakacho, Musashino-shi, Tokyo 180-8550, Japan

www.tascam.com

TEAC AMERICA, INC.

Phone: +1-323-726-0303

7733 Telegraph Road, Montebello, California 90640

www.tascam.com

TEAC CANADA LTD.

Phone: +1905-890-8008 Facsimile: +1905-890-9888

5939 Wallace Street, Mississauga, Ontario L4Z 1Z8, Canada

www.tascam.com

TEAC MEXICO, S.A. De C.V

Phone: +52-555-581-5500

Campeños No. 184, Colonia Granjes Esmeralda, Delegacion Iztapalapa CP 09810, Mexico DF

www.tascam.com

TEAC UK LIMITED

Phone: +44-8451-302511

Unit 19 & 20, The Courtyards Hatters Lane, Watford, Hertfordshire. WD18 8TE, U.K.

www.tascam.co.uk

TEAC EUROPE GmbH

Phone: +49-611-71580

Bahnstrasse 12, 65205 Wiesbaden-Erbenheim, Germany

www.tascam.de
