

TASCAM[®]

TEAC PROFESSIONAL

D01086320A

CD-200i

CD Player/iPod Dock

OWNER'S MANUAL

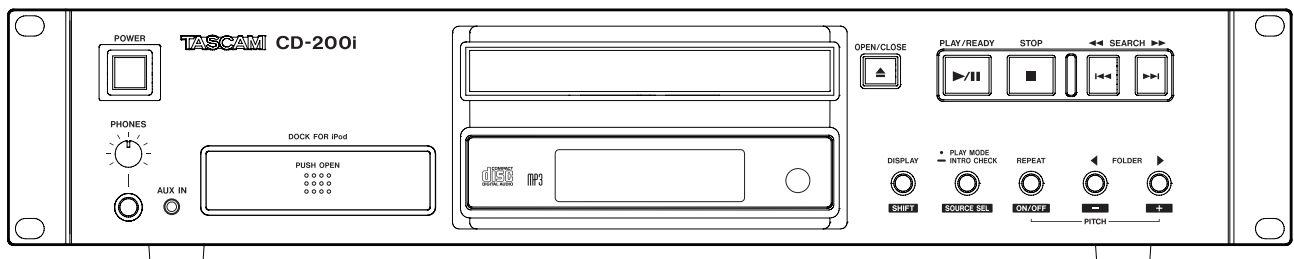

IMPORTANT SAFETY PRECAUTIONS



CAUTION: TO REDUCE THE RISK OF ELECTRIC SHOCK, DO NOT REMOVE COVER (OR BACK). NO USER-SERVICEABLE PARTS INSIDE. REFER SERVICING TO QUALIFIED SERVICE PERSONNEL.



The lightning flash with arrowhead symbol, within equilateral triangle, is intended to alert the user to the presence of uninsulated "dangerous voltage" within the product's enclosure that may be of sufficient magnitude to constitute a risk of electric shock to persons.



The exclamation point within an equilateral triangle is intended to alert the user to the presence of important operating and maintenance (servicing) instructions in the literature accompanying the appliance.

This appliance has a serial number located on the rear panel. Please record the model number and serial number and retain them for your records.

Model number _____

Serial number _____

WARNING: TO PREVENT FIRE OR SHOCK HAZARD, DO NOT EXPOSE THIS APPLIANCE TO RAIN OR MOISTURE.

For U.S.A.

TO THE USER

This equipment has been tested and found to comply with the limits for a Class A digital device, pursuant to Part 15 of the FCC Rules. These limits are designed to provide reasonable protection against harmful interference when the equipment is operated in a commercial environment. This equipment generates, uses, and can radiate radio frequency energy and, if not installed and used in accordance with the instruction manual, may cause harmful interference to radio communications.

Operation of this equipment in a residential area is likely to cause harmful interference in which case the user will be required to correct the interference at his own expense.

CAUTION

Changes or modifications to this equipment not expressly approved by TEAC CORPORATION for compliance could void the user's authority to operate this equipment.

CE Marking Information

- a) Applicable electromagnetic environment: E4
- b) Peak inrush current: 2.0 A

In North America use only on 120V supply.

产品有毒有害物质或元素的名称及含量

机种: CD-200i		有毒有害物质或元素					
品名	铅 (Pb)	汞 (Hg)	镉 (Cd)	六价铬 (Cr6+)	多溴联苯 (PBB)	多溴二苯醚 (PBDE)	
1 CHASSIS部份	○	○	○	○	○	○	
2 FRONT PANEL部份	○	○	○	○	○	○	
3 螺丝部份	○	○	○	○	○	○	
4 线材部份	○	○	○	○	○	○	
5 PCB Assy部份	×	○	○	○	○	○	
6 CD MECH部份	○	○	○	○	○	○	
7 iPod Dock MECH部份	○	○	○	○	○	○	
8 电源部份	○	○	○	○	○	○	
9 附属品部份	×	○	○	○	○	○	
10 LABEL部份	○	○	○	○	○	○	
11 包装部份	○	○	○	○	○	○	

○: 表示该有毒有害物质在该部件所有均质材料中的含量均在 SJ/T11363-2006 标准规定的限量要求以下。

×: 表示该有毒有害物质至少在该部件的某一均质材料中的含量超出 SJ/T11363-2006 标准规定的限量要求。

(针对现在代替技术困难的电子部品及合金中的铅)

IMPORTANT SAFETY INSTRUCTIONS

- 1 Read these instructions.
 - 2 Keep these instructions.
 - 3 Heed all warnings.
 - 4 Follow all instructions.
 - 5 Do not use this apparatus near water.
 - 6 Clean only with dry cloth.
 - 7 Do not block any ventilation openings. Install in accordance with the manufacturer's instructions.
 - 8 Do not install near any heat sources such as radiators, heat registers, stoves, or other apparatus (including amplifiers) that produce heat.
 - 9 Do not defeat the safety purpose of the polarized or grounding-type plug. A polarized plug has two blades with one wider than the other. A grounding type plug has two blades and a third grounding prong. The wide blade or the third prong are provided for your safety. If the provided plug does not fit into your outlet, consult an electrician for replacement of the obsolete outlet.
 - 10 Protect the power cord from being walked on or pinched particularly at plugs, convenience receptacles, and the point where they exit from the apparatus.
 - 11 Only use attachments/accessories specified by the manufacturer.
 - 12 Use only with the cart, stand, tripod, bracket, or table specified by the manufacturer, or sold with the apparatus. When a cart is used, use caution when moving the cart/apparatus combination to avoid injury from tip-over.
 - 13 Unplug this apparatus during lightning storms or when unused for long periods of time.
 - 14 Refer all servicing to qualified service personnel. Servicing is required when the apparatus has been damaged in any way, such as power-supply cord or plug is damaged, liquid has been spilled or objects have fallen into the apparatus, the apparatus has been exposed to rain or moisture, does not operate normally, or has been dropped.
- Do not expose this apparatus to drips or splashes.
 - Do not place any objects filled with liquids, such as vases, on the apparatus.
 - Do not install this apparatus in a confined space such as a book case or similar unit.
 - The apparatus draws nominal non-operating power from the AC outlet with its POWER or STANDBY/ON switch not in the ON position.
 - The apparatus should be located close enough to the AC outlet so that you can easily grasp the power cord plug at any time.
 - The mains plug is used as the disconnect device, the disconnect device shall remain readily operable.
 - Products with Class I construction are equipped with a power supply cord that has a 3-prong grounding plug. The cord of such a product must be plugged into an AC outlet that has a protective grounding connection.
 - If the product uses batteries (including a battery pack or installed batteries), they should not be exposed to sunshine, fire or excessive heat.
 - CAUTION for products that use replaceable lithium batteries: there is danger of explosion if a battery is replaced with an incorrect type of battery. Replace only with the same or equivalent type.
 - Caution should be taken when using earphones or headphones with the product because excessive sound pressure (volume) from earphones or headphones can cause hearing loss.



For the customers in Europe

WARNING

This is a Class A product. In a domestic environment, this product may cause radio interference in which case the user may be required to take adequate measures.

Pour les utilisateurs en Europe

AVERTISSEMENT

Il s'agit d'un produit de Classe A. Dans un environnement domestique, cet appareil peut provoquer des interférences radio, dans ce cas l'utilisateur peut être amené à prendre des mesures appropriées.

Für Kunden in Europa

Warnung

Dies ist eine Einrichtung, welche die Funk-Entstörung nach Klasse A besitzt. Diese Einrichtung kann im Wohnbereich Funkstörungen verursachen; in diesem Fall kann vom Betreiber verlangt werden, angemessene Maßnahmen durchzuführen und dafür aufzukommen.

Safety Information

■ CAUTIONS ABOUT BATTERIES

This product uses batteries. Misuse of batteries could cause a leak, rupture or other trouble. Always abide by the following precautions when using batteries.

- Never recharge non-rechargeable batteries. The batteries could rupture or leak, causing fire or injury.
- When installing batteries, pay attention to the polarity indications (plus/minus (+/-) orientation), and install them correctly in the battery compartment as indicated. Putting them in backward could make the batteries rupture or leak, causing fire, injury or stains around them.
- When you store or dispose batteries, isolate their terminals with insulation tape or something like that to prevent them from contacting other batteries or metallic objects.
- When throwing used batteries away, follow the disposal instructions indicated on the batteries and the local disposal laws.
- Do not use batteries other than those specified. Do not mix and use new and old batteries or different types of batteries together. The batteries could rupture or leak, causing fire, injury or stains around them.
- Do not carry or store batteries together with small metal objects. The batteries could short, causing leak, rupture or other trouble.
- Do not heat or disassemble batteries. Do not put them in fire or water. Batteries could rupture or leak, causing fire, injury or stains around them.
- If the battery fluid leaks, wipe away any fluid on the battery case before inserting new batteries. If the battery fluid gets in an eye, it could cause loss of eyesight. If fluid does enter an eye, wash it out thoroughly with clean water without rubbing the eye and then consult a doctor immediately. If the fluid gets on a person's body or clothing, it could cause skin injuries or burns. If this should happen, wash it off with clean water and then consult a doctor immediately.
- The unit power should be off when you install and replace batteries.
- Remove the batteries if you do not plan to use the unit for a long time. Batteries could rupture or leak, causing fire, injury or stains around them. If the battery fluid leaks, wipe away any fluid on the battery compartment before inserting new batteries.
- Do not disassemble a battery. The acid inside the battery could harm skin or clothing.

■ CAUTIONS ABOUT LASER RADIATION

This product has been designed and manufactured according to FDA regulations "title 21, CFR, chapter 1, subchapter J, based on the Radiation Control for Health and Safety Act of 1968," and is classified as a class 1 laser product. There is no hazardous invisible laser radiation during operation because invisible laser radiation emitted inside of this product is completely confined in the protective housings.

The label required in this regulation is shown at ①.

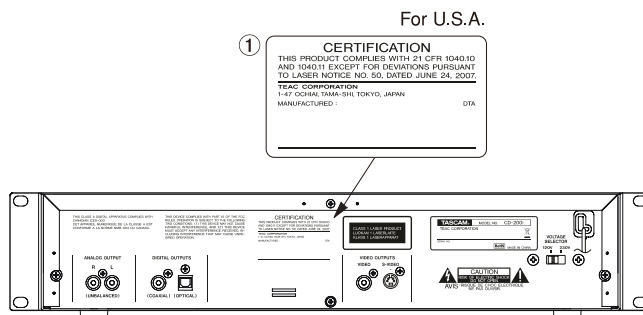

Cautions:

- DO NOT REMOVE THE PROTECTIVE HOUSING USING A SCREWDRIVER.
- USE OF CONTROLS OR ADJUSTMENTS OR PERFORMANCE OF PROCEDURES OTHER THAN THOSE SPECIFIED HEREIN MAY RESULT IN HAZARDOUS RADIATION EXPOSURE.
- IF THIS PRODUCT DEVELOPS TROUBLE, CONTACT YOUR NEAREST QUALIFIED SERVICE PERSONNEL, AND DO NOT USE THE PRODUCT IN ITS DAMAGED STATE.

Optical pickup

Type	: SF-P101VF
Manufacturer	: SANYO Electric Co., Ltd.
Laser output	: Less than 0.25 mW on the objective lens
Wavelength	: 760 to 820 nm

IMPORTANT SAFETY INSTRUCTIONS

■ RACK-MOUNTING THE UNIT

If you are mounting the unit in a rack, leave 2U (10 cm) or more of space above it to prevent interference with devices installed above it and 4 inch (10 cm) or more of space at the rear.

Use the rack-mounting kit to mount the unit in a standard 19-inch equipment rack, as shown below. Remove the feet of the unit before mounting.

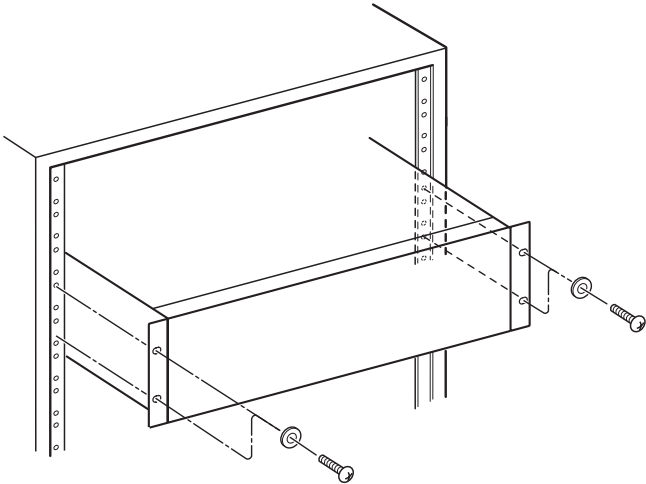

Contents

1 – Introduction	7	Setting the program	26
Main features	7	Checking the program	27
Included items	7	Replacing a program track	27
About this manual	7	Adding more program tracks	27
Trademarks	8	Clearing the program	27
Precautions and notes for placement and use	8	Repeat playback	28
Power supply	8	Time and text information display	28
Beware of condensation	8	Pitch control	29
Cleaning the unit	8	Intro Check	30
About discs	8		
Handling of compact discs	8	5 – iPod Playback	31
2 – Names and Functions of Parts	9	iPod dock	31
Front panel	9	Controlling an iPod	31
iPod dock	10	Settings made on the iPod	31
Rear panel	11	iPod playback	31
Display	12	Setting the iPod video output	31
Remote control unit (RC-CD200i)	13	6 – Message Lists	32
3 – Preparation for Use	15	Operation messages	32
Connecting audio and video devices	15	Warning messages	32
Connecting an iPod	16	Error messages	32
Opening the iPod dock	17	7 – Troubleshooting	33
Closing the iPod dock	17	8 – Specifications	34
Removing a dock adapter	17	Ratings	34
Removing the iPod	18	Input/Output ratings	34
Connecting external audio players	18	Audio performance (CD playback)	34
Preparing the remote control	19	Backup memory	34
Inserting batteries	19	General	35
Replacing the batteries	19	Dimensions	35
Cautions about the use of batteries	19		
Cautions about using the remote control	19		
Changing the output sound source	20		
4 – Playing Back CDs	21		
Discs that can be played	21		
Folders and tracks on data CDs	21		
Loading a CD	22		
Playback	22		
Selecting a track	23		
Skipping to the next or previous track ..	23		
Selecting by track number	23		
Search forward and backward	24		
Folder playback (with data CDs only)	24		
Selecting the folder	24		
Playback modes	25		
Select the playback mode	25		
Programmed playback	25		

1 – Introduction

Thank you for your purchase of the TASCAM CD-200i CD Player/iPod Dock.

Before connecting and using the unit, please take time to read this manual thoroughly to ensure you understand how to properly set up and connect the unit, as well as the operation of its many useful and convenient functions. After you have finished reading this manual, please keep it in a safe place for future reference.

You can also download the Owner's Manual from the TASCAM web site (<http://www.tascam.com>).

Main features

- In addition to audio CDs (CD-DA), plays data CDs (CD-ROM) on which WAV and MP3 format files are recorded.
- CD-R/RW playback
- 2U rack mount size
- Analog output (RCA) and digital outputs (coaxial and optical)
- Headphone output with level control
- 10-key wireless remote control
- Displays textual information (artist name, album name, track name, etc.) including CD text and ID3 tags.
- Three types of play mode (continuous, shuffle, and programmed)
- Repeat playback (single repeat, all repeat)
- $\pm 14.0\%$ pitch control
- Intro check
- Folder repeat for data CDs
- Various time display (track elapsed time, track remaining time and total remaining time for audio CDs, total elapsed time for data CDs).
- 10-second shockproof memory built-in (protection against skipping).
- The built-in iPod dock allows the unit to output sound and video playing back from an iPod, as well as to control and recharge the iPod.
- The stereo mini-jack audio line input allows sound to be input from portable audio devices other than iPods.

Included items

The included items are listed below.

Take care when opening the package not to damage the items. Keep the package materials for transportation in the future.

Please contact the store where you purchased this unit if any of these items are missing or have been damaged during transportation.

- Main unit 1
- Wireless remote control unit (RC-CD200i) 1
- AA batteries for the remote control unit 2
- A rack-mounting screw kit 1
- A warranty card 1
- Owner's manual (this manual) 1

NOTE

The batteries are not supplied for Taiwan.

About this manual

In this manual, we use the following conventions:

- The names of keys and controls are given in the following typeface: **PLAY/READY**.
- When the alphanumeric portion of the display shows a message, this is shown in the following typeface: **OPEN**.
- If a preset indicator in the display (i.e. one which cannot change) is shown, this is shown as follows: **INTRO**.
- The CD-DA format may also be mentioned as “audio CD” format.
- CDs on which MP3 or WAV audio files are recorded may be mentioned as “data CDs”.
- Additional information is introduced in the styles below when needed:

TIP

Useful hints when using the unit.

NOTE

Explanation of actions in special situation and supplement.

CAUTION

Instructions that should be followed to avoid injury, damage to the unit or other equipment, and loss of data.

1 – Introduction

Trademarks

- TASCAM is a registered trademark of TEAC Corporation.
- MPEG Layer-3 audio coding technology licensed from Fraunhofer IIS and Thomson.
- "Made for iPod" means that an electronic accessory has been designed to connect specifically to iPod and has been certified by the developer to meet Apple performance standards.
Apple is not responsible for the operation of this device or its compliance with safety and regulatory standards. iPod is a trademark of Apple Inc., registered in the U.S. and other countries.
- Other company names, product names and logos in this document are the trademarks or registered trademarks of their respective owners.

Precautions and notes for placement and use

- The operating temperature should be between 5°C and 35°C (41°F and 95°F).
- Make sure that the unit is mounted in a level position for correct operation.
- Do not place any object on the unit for heat dissipation.
- Avoid installing this unit on top of any heat-generating electrical device such as a power amplifier.

Power supply

Connect the unit to the standard power outlet. Hold the plug when connecting and disconnecting the power cord.

Beware of condensation

If the unit (or a compact disc) is moved from a cold to a warm place, or used after a sudden temperature change, there is a danger of condensation; vapor in the air could condense on the internal mechanism, making correct operation impossible. To prevent this, or if this occurs, let the player sit for one or two hours at the new room temperature before using.

Cleaning the unit

To clean the unit, wipe it gently with a soft dry cloth. Do not wipe with chemical cleaning cloths, benzene, paint thinner, ethyl alcohol or other chemical agents to clean the unit as they could damage the surface.

About discs

In addition to audio CDs (CD-DA), the CD-200i can play CD-R and CD-RW discs on which audio CD, MP3, or WAV

format files are recorded. The CD player can also play 3-inch CDs

Handling of compact discs

- Always place the compact discs in the trays with their label facing upward.
- To remove a disc from its case, press down on the center of the disc holder, then lift the disc out, holding it carefully by the edges.
- Do not touch the signal side (the unlabeled side). Fingerprints, oils and other substances can cause errors during playback.
- To clean the signal side of a disc, wipe gently with a soft dry cloth from the center towards the outside edge. Dirt on discs can lower the sound quality, so clean them and always store them in a clean state.
- Do not use any record spray, anti-static solutions, benzene, paint thinner or other chemical agents to clean CDs as they could damage the delicate playing surface. It may cause CDs to become unplayable.
- Do not apply labels or other materials to discs. Do not use discs that have had tape, stickers or other materials applied to their surface. Do not use discs that have sticky residue from stickers, etc. Such discs could become stuck in the unit or cause it to malfunction.
- Never use a commercially available CD stabilizer. Using stabilizers with this player will damage the mechanism and cause it to malfunction.
- Do not use cracked discs.
- Only use circular compact discs. Avoid using non-circular promotional, etc. discs.



- Music discs with copy control, a copy-protection system, have been released from several record companies in an attempt to protect the copyright. Since some of these discs do not comply with the CD specifications, they may not be playable on the CD-200i.

2 – Names and Functions of Parts

Functions work with the output sources (CD, iPod and AUX IN) indicated next to the part name in the explanation below when selected.

Front panel

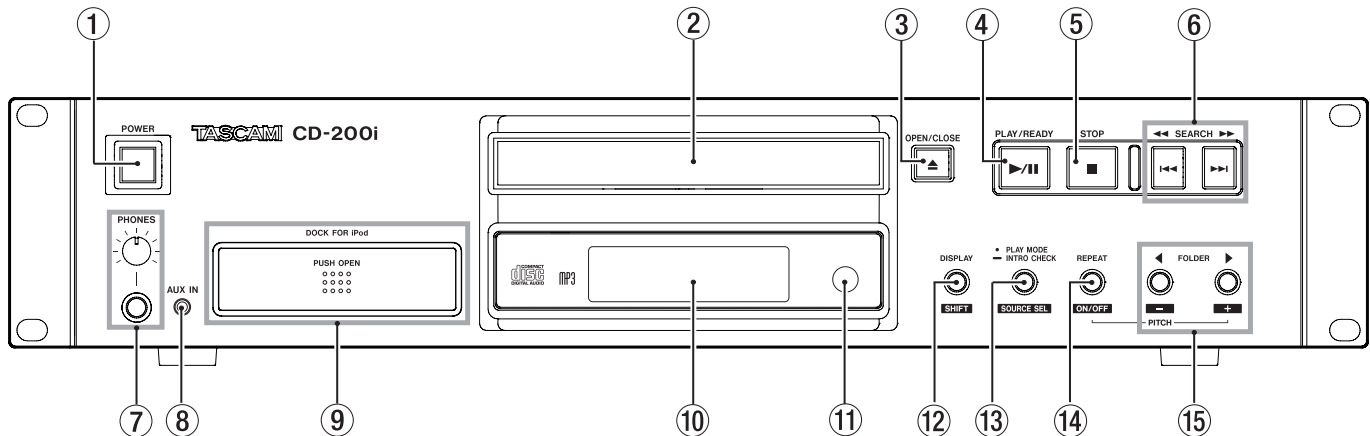

- ① **POWER switch**
Press this switch to turn the unit on or off.

CAUTION

Before turning on the power, minimize the volume of connected devices. Failure to do so could cause a sudden burst of loud noise, which might result in hearing damage, for example.

- ② **Disc tray**
Insert discs (CD, CD-R, CD-RW) here.
- ③ **OPEN/CLOSE key**
Use to open and close the disc tray.
- ④ **PLAY/READY (▶/||) key (CD and iPod)**
Press during playback to pause. When playback is stopped or paused, press to start playback.
- ⑤ **STOP (■) key (CD and iPod)**
When the output source is set to CD, press this key to stop playback.
When the output source is set to iPod, press this key to pause playback.
- ⑥ **SKIP/SEARCH ◀◀/|◀◀/▶▶/▶▶ keys (CD and iPod)**
Press briefly to select tracks (skip). Press and hold to search a track.
- ⑦ **PHONES jack and knob (CD, iPod and AUX IN)**
Use this standard stereo phones jack to connect stereo headphones. Use a plug adapter when connecting headphones with mini-plugs.
Use the **PHONES** knob to adjust the headphone output level.

CAUTION

Use the PHONES knob to minimize the volume before connecting headphones. Failure to do so could cause a sudden burst of loud noise, which might result in hearing damage, for example.

- ⑧ **AUX IN jack**
This is a stereo mini-jack audio line input that can be used to connect portable digital players and other external audio devices.

CAUTION

Minimize the volume on the external device before connecting it to the AUX IN jack. Failure to do so could cause a sudden burst of loud noise, which might result in hearing damage, for example.

- ⑨ **DOCK FOR iPod**
Press the front of the iPod dock panel to unlock it so that it can be pulled forward. Insert the appropriate dock adapter and connect the iPod.
When not in use, remove the iPod and press the dock panel while pressing and holding the **CLOSE** button until it shuts with a clicking sound. (See “Connecting an iPod” on page 16.)
- ⑩ **Display**
Displays various information.
- ⑪ **Remote Sensor**
When operating the remote control unit (RC-CD200i), point it towards here.

2 – Names and Functions of Parts

⑫ DISPLAY (SHIFT) key (CD and iPod)

When the output source is set to CD, press this key to change the type of time and text information shown on the display. When this key is pressed, the type of information currently displayed is shown for two seconds. Press the key again during this time to change the type of information shown. The information that can be shown depends on the type of disc and the status of operation. (See “Time and text information display” on page 28.)

When iPod is selected, you can switch whether its video is shown on the iPod itself or output through this unit’s VIDEO OUT jack.

You cannot, however, switch the video output destination during video playback. Switch it while the iPod is stopped or stop the playback once and then switch it if the iPod is already playing back.

If switched during video playback, the new output destination is used when playback is stopped then started again.

When pressed at the same time as another key, this key acts as the shift key, enabling the functions labeled under each key in black characters on a white background.

⑬ PLAY MODE/INTRO CHECK (SOURCE SEL) key (CD and iPod)

When the output source is set to CD, press this key briefly to change the playback mode. The three types of playback modes are continuous, shuffle and programmed. (See “Playback modes” on page 25.)

During playback or when stopped, press and hold this key to use the intro check playback feature. The beginning of each track on the CD plays for 10 seconds in order. During intro check playback, press and hold this key again to return to the previous playback mode and continue playing the current track. (See “Intro Check” on page 30.)

Press this key while holding down the DISPLAY (SHIFT) key to cycle through the sound output sources in the following order (see “Changing the output sound source” on page 20.):

→ CD → iPod → AUX IN

When the output source is set to iPod, press to cycle through the three iPod shuffle modes, which include Off, Song and Album.

NOTE

- The intro check function cannot be used with iPods.
- iPod and AUX IN cannot be selected if devices are not connected to this unit.

⑭ REPEAT (PITCH ON/OFF) key (CD and iPod)

Press this key to cycle through the repeat playback modes in the following order (see “Repeat playback” on page 28.):

→ Repeat single track → Repeat all tracks → Repeat off

Press this key while holding down the DISPLAY (SHIFT) key to turn the pitch control function ON and OFF. (See “Pitch control” on page 29.)

NOTE

The pitch control function cannot be used with iPods.

⑮ FOLDER ◀/▶ (PITCH -/+) key (CD and iPod)

Use these keys when the output source is set to CD and a data CD is loaded to change the playback folder. Select ALL to set the entire disc as the playback area. (See “Folder playback (with data CDs only)” on page 24.)

When the output source is set to iPod, use these to select (skip between) albums.

Use these keys while holding down the DISPLAY (SHIFT) key to set the pitch control value. (See “Pitch control” on page 29.)

NOTE

The pitch control function cannot be used with iPods.

iPod dock

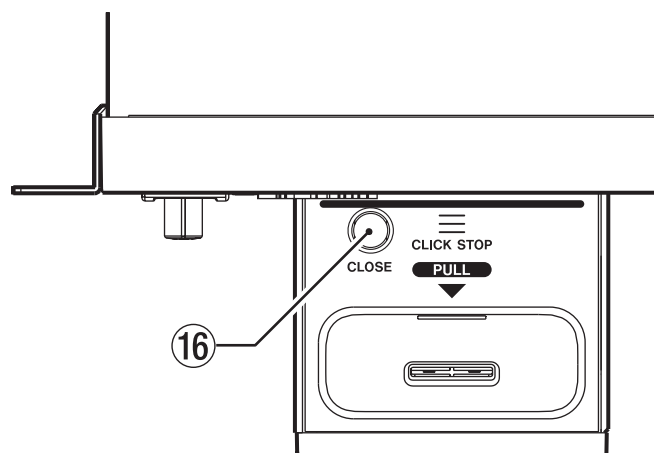

⑯ CLOSE button

Press this button to unlock the iPod dock when you want to close it.

To close the iPod dock, press the dock panel while pressing and holding this button.

2 – Names and Functions of Parts

Rear panel

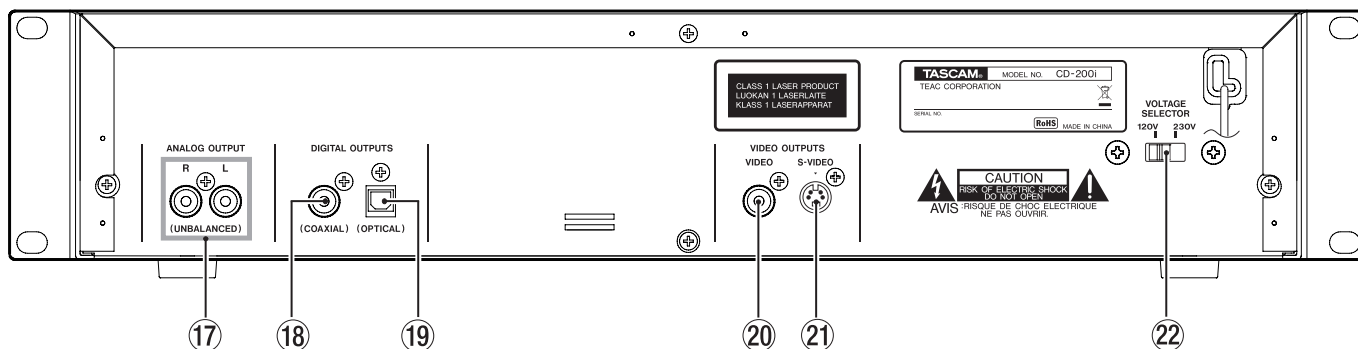

17 ANALOG OUTPUT (UNBALANCED) jacks (CD, iPod and AUX IN)

These jacks output analog signals (–10 dBV) of the CD or iPod playback sound signal or the signals input through the **AUX IN** jack.

18 DIGITAL OUTPUT (COAXIAL) jack (CD)

This jack outputs the CD playback signal in S/PDIF digital format.

NOTE

The iPod playback sound signal and the AUX IN input can only be output from the analog jacks. Digital output of these signals is not possible.

CAUTION

- When MP3 or WAV file is playing, the sampling frequency of digital output is 44.1 kHz.
- Digital output is possible when the pitch control function is on with Audio CD, MP3, or WAV file, but the sampling frequency is changed by an amount proportional to the pitch control value.
- When pitch control is ON, digital output signal from CD-200i cannot be received in some equipment.

19 DIGITAL OUTPUT (OPTICAL) jack (CD)

This jack outputs the CD playback signal in S/PDIF digital format.

NOTE

The iPod playback sound signal and the AUX IN input can only be output from the analog jacks. Digital output of these signals is not possible.

CAUTION

- When MP3 or WAV file is playing, the sampling frequency of digital output is 44.1 kHz.
- Digital output is possible when the pitch control function is on with Audio CD, MP3, or WAV file, but the sampling frequency is changed by an amount proportional to the pitch control value.
- When pitch control is ON, digital output signal from CD-200i cannot be received in some equipment.

20 VIDEO OUTPUT (iPod)

iPod playback video signal is transmitted through this composite video output jack.

Please change the iPod's TV signal setting (NTSC or PAL) and TV Screen (or Widescreen) setting to suit the connected device.

21 S-VIDEO OUTPUT (iPod)

iPod playback video signal is transmitted from this S-VIDEO output jack.

Please change the iPod's TV signal setting (NTSC or PAL) and TV Screen (or Widescreen) setting to suit the connected device.

22 VOLTAGE SELECTOR

Switches the voltage to either 230 V or 120 V.

NOTE

- The voltage selector is only available on units for specific markets.
- In North America, use only on 120V supply.

2 – Names and Functions of Parts

Display

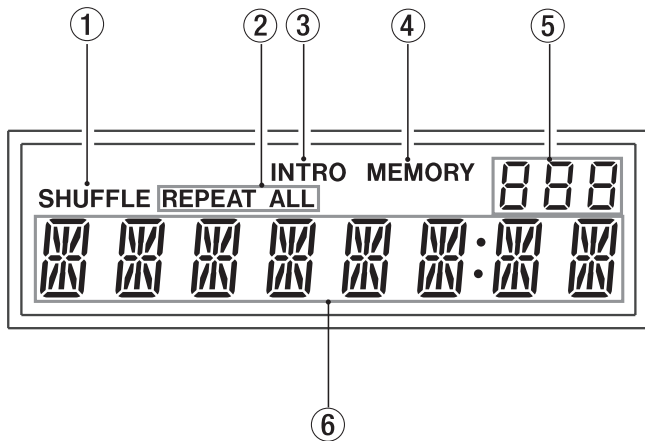

- ① **SHUFFLE (CD and iPod)**
The **SHUFFLE** indicator appears during shuffle playback mode.

If the output source is an iPod, this indicator lights during song shuffle playback and blinks during album shuffle playback.
- ② **REPEAT, ALL (CD and iPod)**
REPEAT ALL appears when it is set and **REPEAT** appears when single repeat is set.
- ③ **INTRO (CD)**
INTRO lights when this function is on.
- ④ **MEMORY (CD)**
MEMORY lights when programmed playback is on and blinks while you are setting the program.
- ⑤ **Folder number (CD)**
When a data CD is in the unit, the folder number is shown when set to folder playback, and **ALL** is shown when set to disc playback (all folders). When an audio CD is in the unit, **CD** is shown.
- ⑥ **Alphanumeric display (CD and iPod)**
The track number and time or text information is shown. The status of the unit (**OPEN**, **CLOSE**, **TOC* READ**, etc.) and messages (**NO DISC**, etc.) are also shown. Items with more than eight characters are scrolled when shown.

* *TOC* means "Table Of Contents," which is track information written on the disc

CAUTION

When a fourth-generation iPod or iPod mini is connected, and the output source is set to iPod, the **SHUFFLE** and **REPEAT** indicators are not shown on this unit's display. Check the iPod itself to confirm the iPod's current playback and repeat mode.

2 – Names and Functions of Parts

Remote control unit (RC-CD200i)

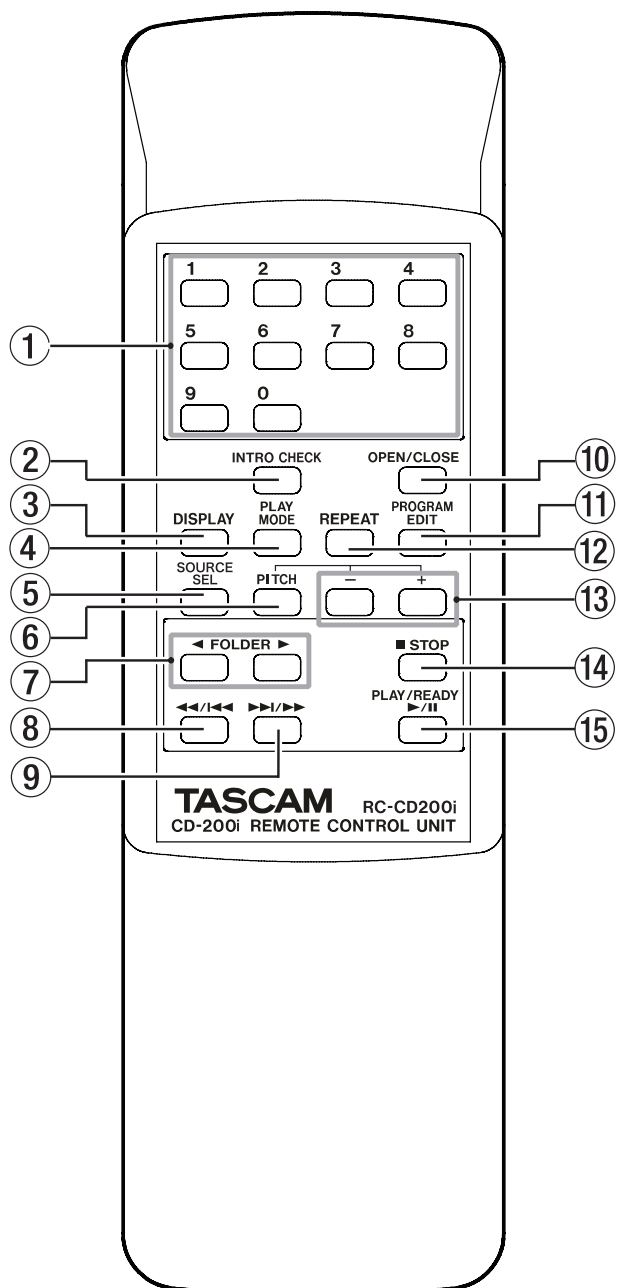

- ① **Numeric keys (CD)**
Use the numeric keys to select tracks by their track numbers (See “Selecting by track number” on page 23.) A track number can have a maximum of two digits for audio CDs and a maximum of three digits for data CDs.
- ② **INTRO CHECK key (CD)**
During playback or when paused, press and hold this key to use the intro check playback feature. The beginning of each track on the CD will be played for 10 seconds in order. During intro check playback, press and hold this key again to return to the previous playback mode. (See “Intro Check” on page 30.)
- ③ **DISPLAY key (CD and iPod)**
When the output source is set to CD, press this key to change the type of time and text information shown on the display. When this key is pressed, the type of information currently displayed is shown for two seconds. Press the key again during this time to change the type of information shown. The information that can be shown depends on the type of disc and the status of operation. (See “Time and text information display” on page 28.)

When iPod is selected, you can switch whether its video is shown on the iPod itself or output through this unit’s **VIDEO OUTPUT** jack.

You cannot, however, switch the video output destination during video playback. Switch it while the iPod is stopped or stop the playback once and then switch it if the iPod is already playing back.

If switched during video playback, the new output destination is used when playback is stopped then started again.

- ④ **PLAY MODE key (CD and iPod)**
Changes the playback mode when the output source is set to CD. The three types of playback modes are continuous, shuffle and programmed. (See “Playback modes” on page 25.)

When the output source is set to iPod, press to cycle through the three iPod shuffle modes, which include Off, Song and Album.
- ⑤ **SOURCE SELECT key**
Press this key to cycle through the sound output sources in the following order (see “Changing the output sound source” on page 20.):

→ CD → iPod → AUX IN
- ⑥ **PITCH ON/OFF key (CD)**
Press this key to turn the pitch control function ON and OFF. (See “Pitch control” on page 29.)

2 – Names and Functions of Parts

⑦ **FOLDER ◀/▶ keys (CD and iPod)**

Use these keys when the output source is set to CD and a data CD is loaded to change the playback folder. Select ALL to set the entire disc as the playback area. (See “Folder playback (with data CDs only)” on page 24.)

When the output source is set to iPod, use these to select (skip between) albums.

⑧ **◀◀/▶▶ key (CD and iPod)**

Press briefly to select tracks (skip). Press and hold to search a track.

⑨ **▶▶/▶▶ key (CD and iPod)**

Press briefly to select tracks (skip). Press and hold to search a track.

⑩ **OPEN/CLOSE key (CD)**

Use to open and close the disc tray.

⑪ **PROGRAM EDIT key (CD)**

When the output source is set to CD, use this to make, confirm and edit program settings. (See “Programmed playback” on page 25.)

⑫ **REPEAT key (CD and iPod)**

Press this key to cycle through the repeat playback modes in the following order:



⑬ **PITCH +/- keys (CD)**

Use these keys to set the pitch control value. (See “Pitch control” on page 29.)

⑭ **STOP key (CD and iPod)**

When the output source is set to CD, press this key to stop playback.

When the output source is set to iPod, press this key to pause playback.

⑮ **PLAY/READY key (CD and iPod)**

Press during playback to pause. When playback is stopped or paused, press to start playback.

3 – Preparation for Use

Before connecting other devices, read their operation manuals and connect them properly. Connect the power last.

Connecting audio and video devices

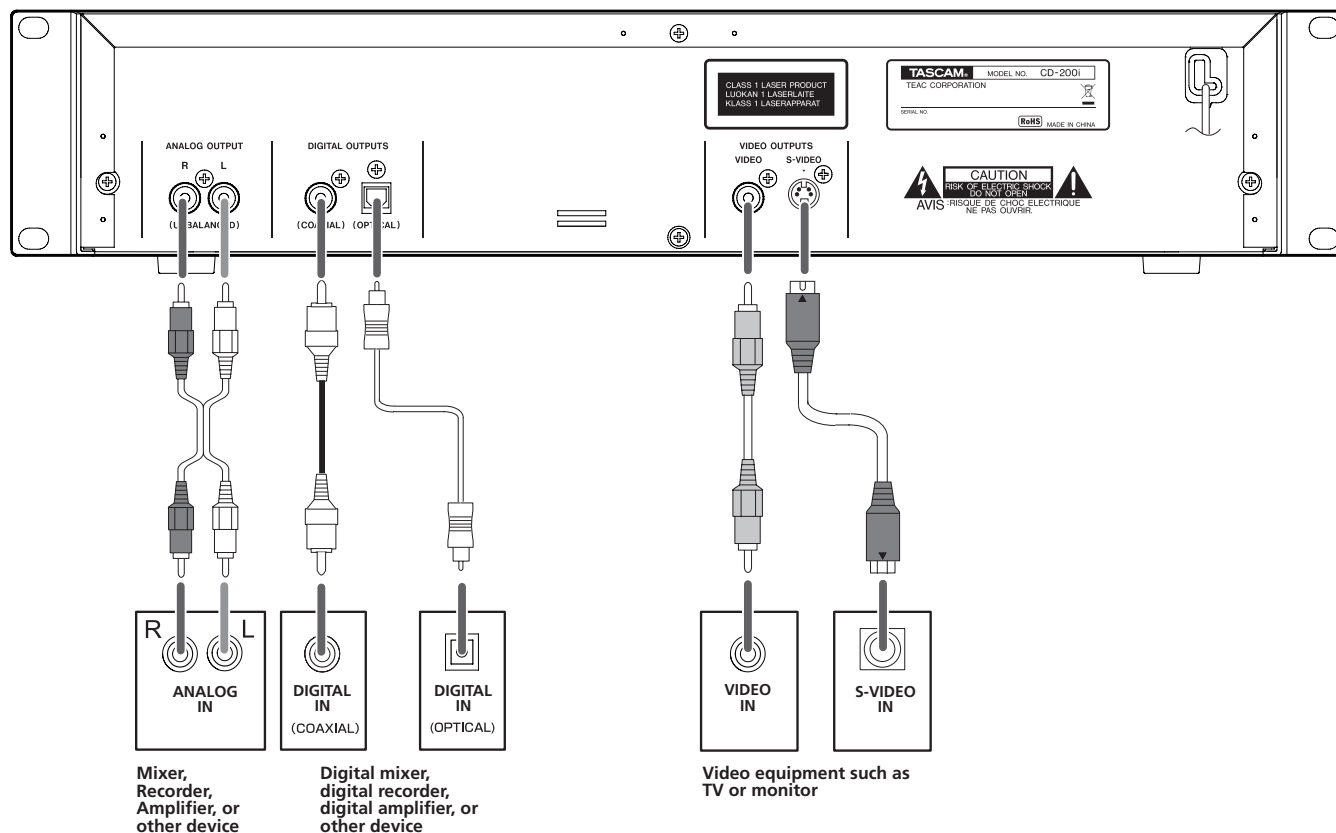

■ Connecting analog audio devices

Connect the analog output jacks of this unit to the input jacks of a stereo amplifier, mixer, recorder or other device with analog inputs.

NOTE

- Cables are not included with this unit.
- Do not bundle RCA cables with power cords or speaker cables. Doing so could cause reduced audio quality or noise.

■ Connecting digital audio devices

Connect a digital output jack (coaxial or optical) of this unit to the input jack of a stereo amplifier, mixer, recorder or other device with a digital input.

NOTE

The iPod playback sound signal and signals input through the AUX IN jacks can only be output as analog signals. They cannot be output as digital signals.

CAUTION

- This unit's digital output during MP3 and WAV file playback has a sampling frequency of 44.1 kHz.
- During playback of MP3 and WAV files on audio CDs, digital output is possible when the pitch control function is in use, but the sampling frequency is changed by an amount equivalent to the pitch control value. When the pitch control function is on, some devices might not be able to accept signals from the digital outputs of this unit.

■ Connecting video devices

Connect the VIDEO or S-VIDEO output jack of this unit to the video input jack of a television or other video device.

Please change the iPod's TV signal setting (NTSC or PAL) and TV Screen (or Widescreen) setting to suit the connected device.

3 – Preparation for Use

Connecting an iPod

Connecting an iPod with the iPod dock on the front panel allows the unit to output the sound of music and video playback from the iPod, as well as to control and recharge the iPod.

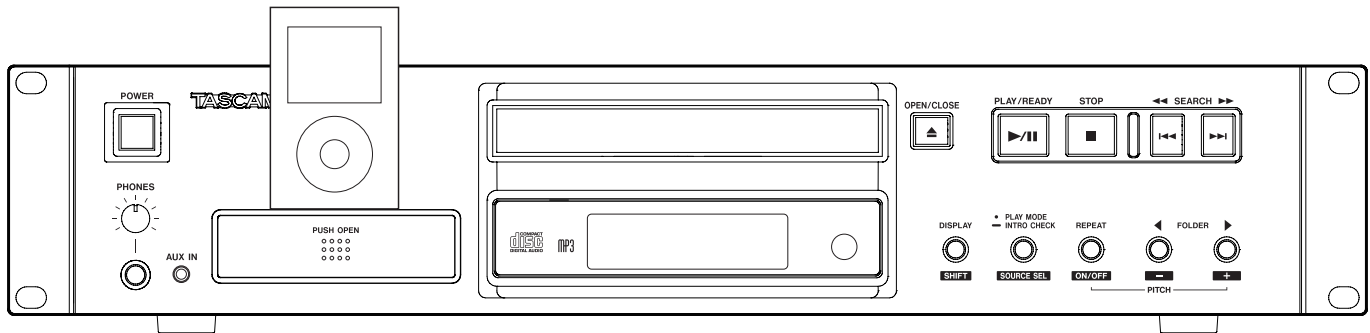

Always attach a dock adapter suitable for your iPod to the connector. Dock adapters are not included with this product. Use the dock adapter included with your iPod or a commercially available Apple iPod Universal Dock Adapter made by Apple Inc.

CAUTION

- When an iPod is inserted into this unit's iPod dock, the top of the iPod is higher than the top of the unit. Leave 2U (10 cm) or more space open about the unit to prevent interference with devices installed above it.
- This unit is compatible with iPod's equipped with fourth generation or later Dock connectors.
- iPod shuffles do not have dock connectors, so they cannot be used with the dock. They can, however, be connected using the AUX IN jack (see "Connecting external audio players" on page 18).
- Always remove any case from an iPod before connecting it. Connecting with a case on might prevent complete connection and proper operation and playback.
- Always use an adapter that is suitable for the iPod that you are using. The use of an unsuitable adapter could damage the connectors of both devices.

NOTE

When an iPod is connected to this unit's iPod dock, it will be recharged whenever this unit's power is ON. When the iPod is completely charged, the unit stops charging. When the unit's power is OFF, it does not charge connected iPods.

During charging, a battery icon appears on the iPod screen that shows the charging status. Please see the operation manual for the iPod that you are using for details.

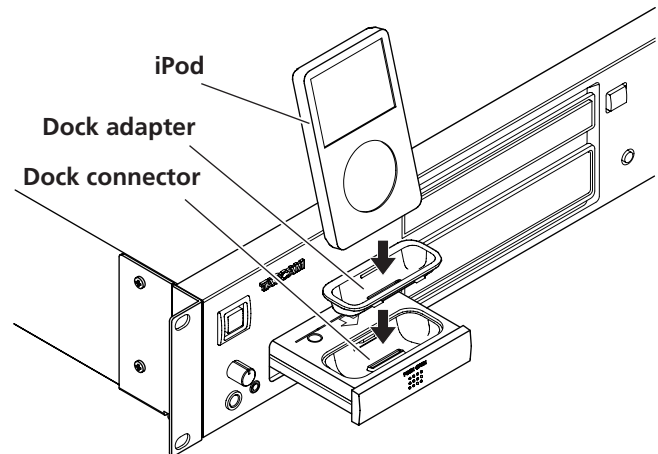

3 – Preparation for Use

Opening the iPod dock

Press the center of the iPod dock, where it says “PUSH OPEN” to open the dock, and then pull it out. Pull the iPod dock completely out until it locks into place before using it

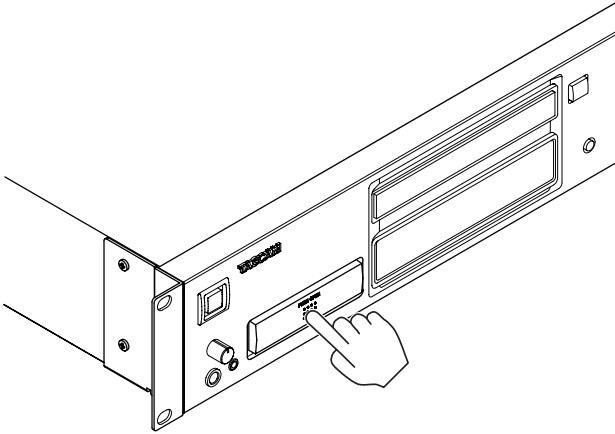

Locked position of dock after it is pulled out

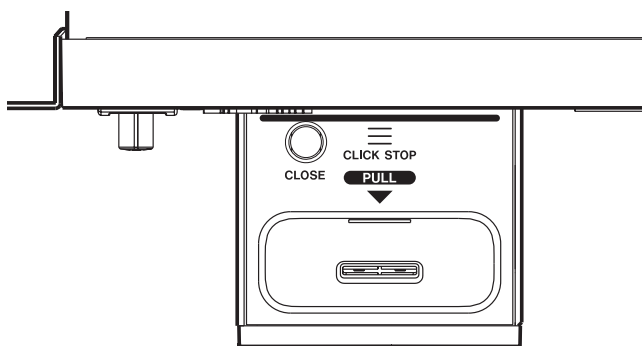
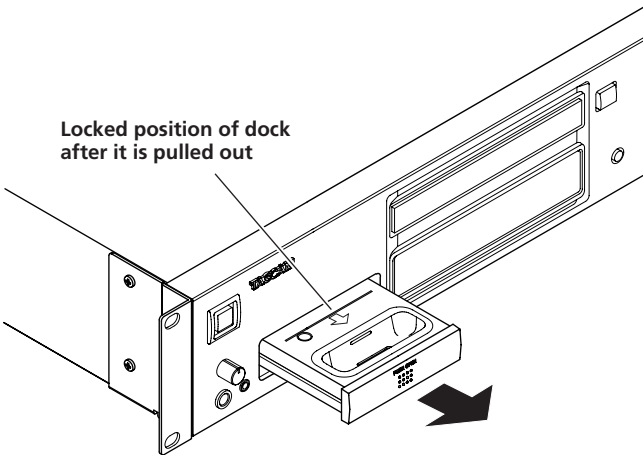

CAUTION

- Do not move the iPod dock left, right, up or down when it is pulled out.
- Do not place anything other than an iPod on the iPod dock when it is pulled out.

Closing the iPod dock

Remove the iPod, and then press the panel while pressing and holding the CLOSE button.

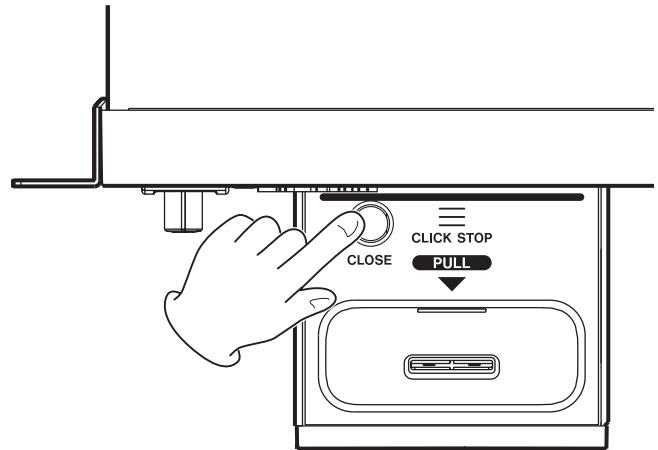

Removing a dock adapter

As shown in the illustration below, insert a flathead screwdriver into the hole in the dock adapter and then use the driver to remove the adapter.

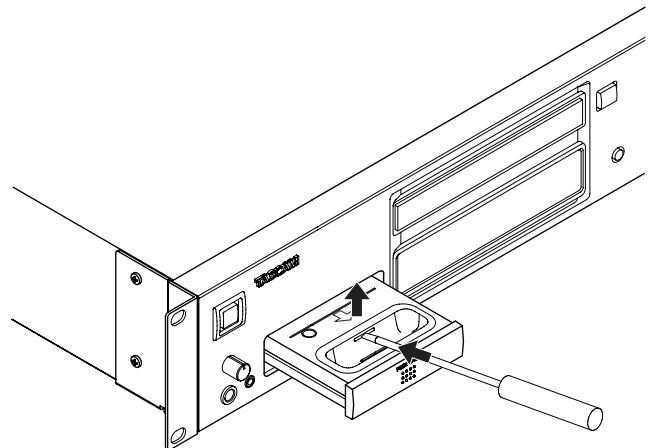

CAUTION

- When removing the dock adapter, use a hand to hold the iPod dock in place.
- Do not move the iPod dock left, right, up or down when it is pulled out.

3 – Preparation for Use

Removing the iPod

- Before connecting or disconnecting an iPod, set the output source to CD or AUX (not iPod), or turn the CD player's power OFF.
- When connecting and disconnecting an iPod, align it with the dock connector and proceed gently to prevent putting pressure on the dock connector.

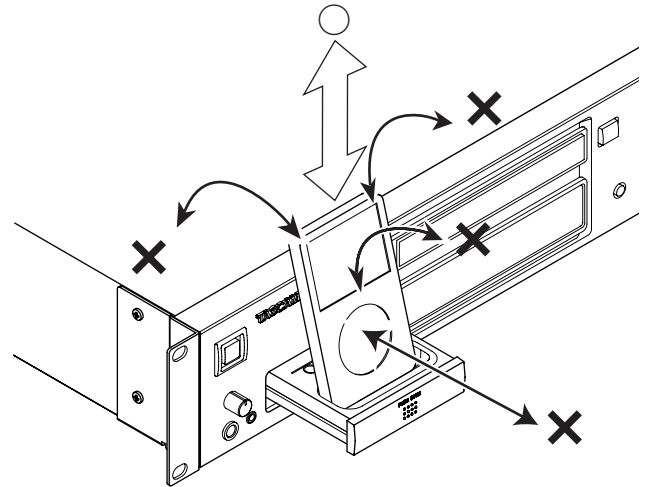

Connecting external audio players

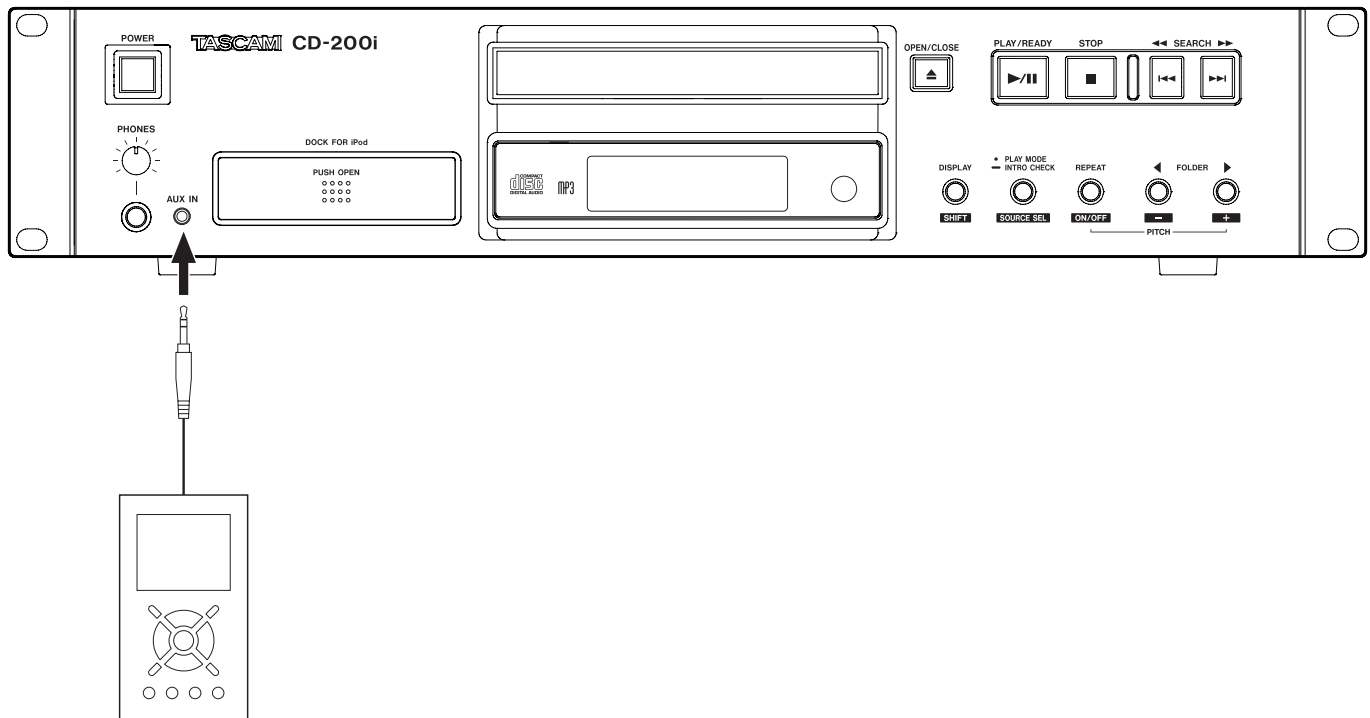

By using the **AUX IN** input on the front panel of this unit to connect the analog outputs of other audio players and iPods that do not have dock connectors, you can transmit the output of these devices from the output jacks of this unit. Since the **AUX IN** does not have an input level adjustment, adjust the output level of the connected device.

CAUTION

- *Minimize the volume of an external device before connecting it to the AUX IN. Failure to do so could cause a sudden burst of loud noise, which might result in hearing damage, for example.*
- *Before connecting or disconnecting something to the AUX IN jack, set the output source to CD or iPod (not AUX), or turn the CD-200i's power OFF.*

3 – Preparation for Use

Preparing the remote control

Inserting batteries

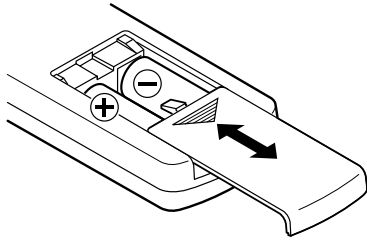

1. Open the lid.
2. Confirm +/- polarity, and insert two AA batteries.
3. Close the lid.

NOTE

The batteries are not supplied for Taiwan.

Replacing the batteries

Replace both batteries with new ones when the range of the remote control becomes short or if the function keys become unresponsive.

Cautions about the use of batteries

Misuse of batteries could cause them to leak, rupture or otherwise be damaged. Please read and abide by the precautions on them when using batteries. Also see "Cautions about batteries" on page 4.

Cautions about using the remote control

- When using other devices controlled by infrared rays, use of this remote control might operate these devices by mistake.
- Use the remote control within the following range.

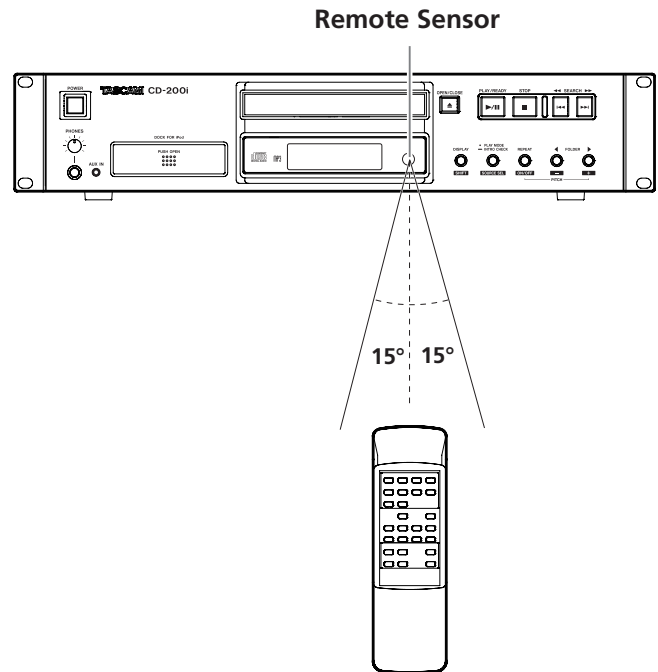

Operation distance

Directly in front: Within 7 meters

15° left or right: Within 7 meters

3 – Preparation for Use

Changing the output sound source

For the audio signal output by this unit, the CD playback sound, the playback sound of the iPod connected to the iPod dock or the sound input through the AUX IN jack can be selected.

Press the **PLAY MODE/INTRO CHECK (SOURCE SEL)** key while pressing the **DISPLAY (SHIFT)** key on the front panel, or press the **SOURCE SELECT** key on the remote control.

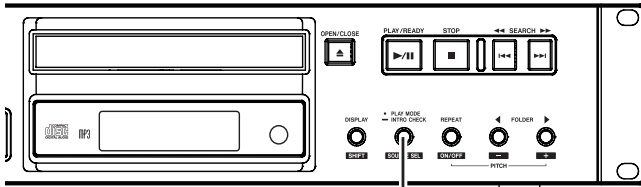

PLAY MODE/INTRO CHECK (SOURCE SEL) key

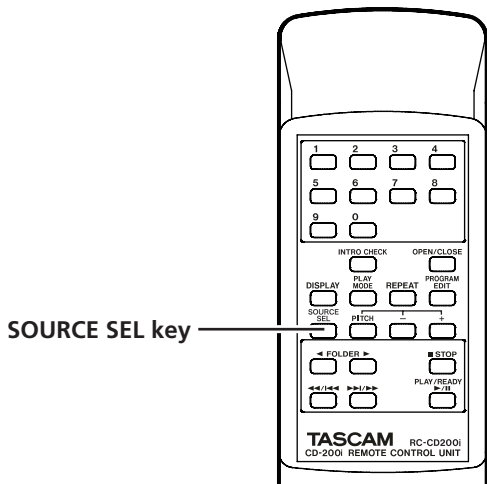

By the above operation, the sound output sources will cycle through in the following order:

→ CD → iPod → AUX IN



[When the output source is iPod]



[When the output source is AUX IN]

CAUTION

- iPod and AUX IN cannot be selected if devices are not connected to this unit.
- When changing the output source from CD to iPod, CD playback or paused mode is stopped. Moreover, when changing the output source from iPod to AUX IN, if the iPod is playing, playback pauses.

NOTE

Even when the output source is changed, CD playback mode settings, the current folder and program contents are not erased.

4 – Playing Back CDs

Discs that can be played

This unit can play the following types of files and discs.

■ CD-DA (audio CD) format discs

Music CDs that are commercially available and CD-R and CD-RW discs that have been recorded as audio CD format can be played. In this manual, these types of discs are called “audio CDs.”

CAUTION

This unit cannot read CD-R discs that have not been finalized.

■ CD-ROM (data CD) format discs

This unit can play back discs with MP3 files or WAV files in ISO 9660 Level 1, Level 2 or Joliet format. In this manual, these types of discs are called “data CDs.”

NOTE

MP3 files that have a sampling frequency of 32, 44.1 or 48 kHz and a bit rate of 32–320 kbps or variable bit rate (VBR) can be played back.

WAV files that have a sampling frequency of 8 kHz – 48 kHz and are 8-bit or 16-bit can be played back.

CAUTION

- *During MP3 and WAV file playback, the digital output of this unit has a sampling frequency of 44.1 kHz. Digital output is possible when pitch control is ON, but the sampling frequency is altered in proportion to the pitch control value. When the pitch control function is ON, therefore, some equipment might not be able to receive the digital output of this unit.*
- *When using a computer or other device to create discs with MP3 files, read the manual for the software that you are using carefully.*
- *This unit's display can only show single-byte characters (alphabet and numbers). File with names that use Japanese, Chinese or other double-byte characters can be played back, but their names cannot be shown correctly on the display.*
- *The unit identifies MP3 files with the “.mp3” file extension. This unit cannot play MP3 files that do not have the “.mp3” file extension, so always include the “.mp3” file extension at the end of the name of an MP3 file. The unit cannot play files that are not in the MP3 data format even if they have the “.mp3” file extension.*
- *The unit identifies WAV files with the “.wav” file extension. This unit cannot play WAV files that do not have the “.wav” file extension, so always include the “.wav” file extension at the end of the name of an WAV file. The unit cannot play files that are not in the WAV data format even if they have the “.wav” file extension.*
- *Discs with 1,000 or more files or 513 or more folders might not play correctly.*

- *Depending on disc conditions, this unit might not be able to play some discs, or skips in the sound might occur.*

Folders and tracks on data CDs

This unit treats all the audio files (WAV and MP3) on data CDs as “tracks.” Some data CDs store files inside folders in the same way that ordinary computers do. In addition, multiple folders can be stored inside another folder creating a multilevel structure.

This unit assigns a folder number to each folder to manage them. Folder numbers are assigned sequentially starting with the first folder at the highest level followed by the folders (subfolders) inside it. Folders inside a higher-level folder are numbered in order before the next folder in the higher-level is numbered as shown in the illustration below.

If the root folder of a data CD contains one or more audio files, it will be numbered as the first folder.

Each audio file is also assigned a track number. Track numbers are assigned in order starting from those in the lowest numbered folder.

During continuous playback of data CDs, tracks are played back just like an audio CD in the order of their assigned numbers.

Folders that do not directly contain audio files are not given numbers. For example, folders C and D in the illustration below would not be assigned numbers.

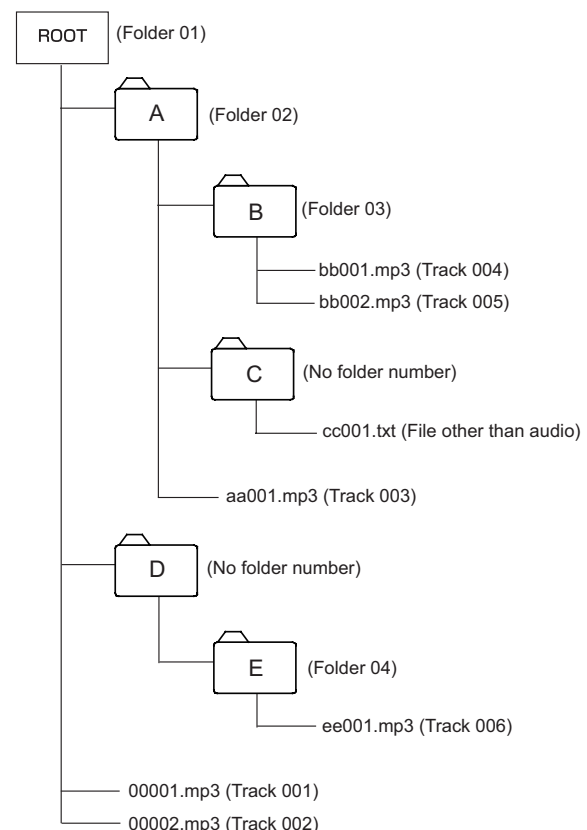

An Example of Data CD Structure

4 – Playing Back CDs

Loading a CD

To load a CD, press the **OPEN/CLOSE** key on the main unit or on the remote control to open the disc tray, and put the CD into the tray with the label facing up.

Press the **OPEN/CLOSE** key again to close the disc tray. After loading the disc, the unit reads the disc's information and shows on the display the total number of tracks and total playback time if it is an audio CD and the total number of tracks in the current folder if it is a data CD.

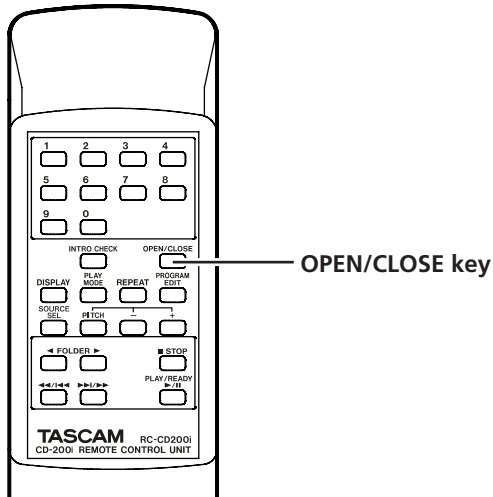
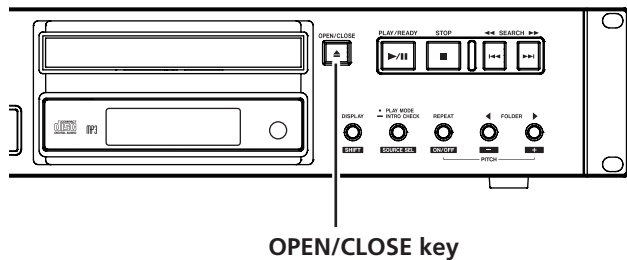

NOTE

Instead of pressing the **OPEN/CLOSE** key to close the disc tray, you can press the **PLAY/READY** key to close the disc tray and begin playback immediately.

CAUTION

If you open the disc tray while this unit is in use, the following settings are lost.

- Program
- Current folder (for data CDs)

Playback

The following procedures assume that the necessary connections have been completed, the unit's power has been turned on and a CD (audio or data) has been loaded.

Press the **PLAY/READY key on the main unit or remote control to begin playback of a CD.**

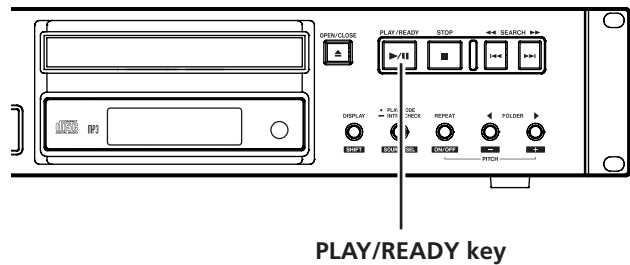

■ Stopping playback:

Press the **STOP** key on the main unit or the remote control.

■ Pausing playback:

Press the **PLAY/READY** key on the main unit or the remote control.

In this manual, unless stated otherwise, explanations are given assuming that continuous playback mode is set. (See “Playback modes” on page 25.)

4 – Playing Back CDs

Selecting a track

There are two ways to select a track. You can move (skip) to the previous or next track, or you can select a track directly by its track number.

Skipping to the next or previous track

Press a SEARCH ◀◀/▶▶ (|◀◀/▶▶|) key on the main unit or a search (◀◀/|◀◀, ▶▶|/▶▶) key on the remote control.

After selecting the track, press the PLAY/READY key on the main unit or the remote control to start track playback.

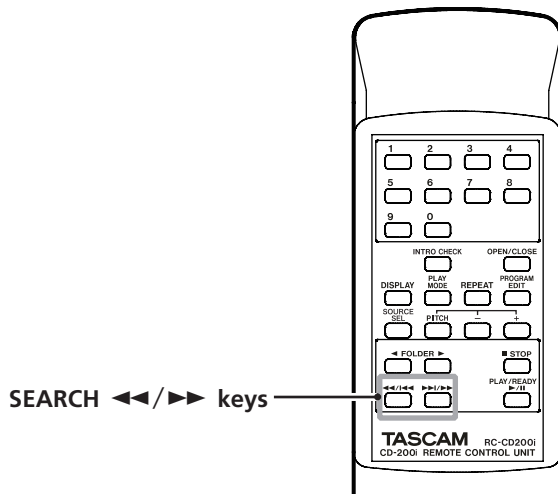
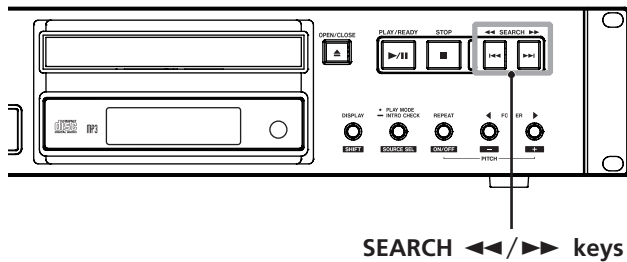

Selecting by track number

Use the numeric keys (0–9) on the remote control to directly set a track for playback by number.

Track numbers can have up to two digits for audio CDs and up to three digits for data CDs.

- 1 Use the remote control numeric keys (0–9) to input the track number. Input the track number starting with the first digit as in the example below.

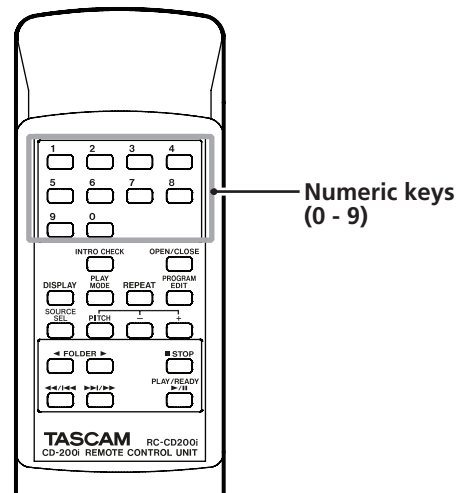

- To select track 1:

Press the “1” key one time.

- To select track 12:

Press the “1” key followed by the “2” key.

- 2 Press the PLAY/READY key on the main unit or the remote control.

The selected track begins to play.

If you press the STOP key on the main unit or the remote control, the display stops showing the track number input and the display returns to its previous state.

NOTE

The numeric keys cannot be used to select a track when in program or shuffle mode.

4 – Playing Back CDs

Search forward and backward

You can search forward and backward in a track while listening to it.

- 1 Play or pause the desired track.
- 2 Press and hold a SEARCH \lll/\ggg (\lll/\ggg) key on the main unit or a search (\lll/\lll , \ggg/\ggg) key on the remote control to start searching forward or backward.
- 3 Release the key that you are holding to stop searching and return the unit to the state it was in before searching (playback or pause).

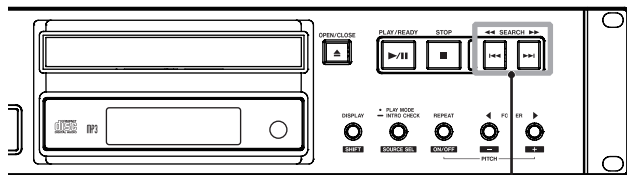

SEARCH \lll/\ggg keys

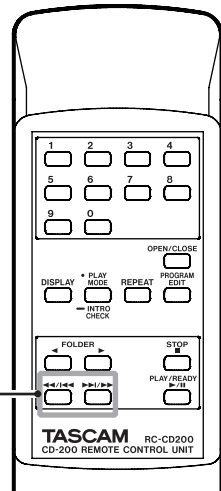

Search \lll/\ggg keys

NOTE

MP3 and WAV files can also be searched forward and backward.

Folder playback (with data CDs only)

When playing a data CD, you can set a designated folder (the current folder) as the playback area. Follow the procedures below to set the playback folder. You can also set the playback area to be the entire disc by selecting "ALL."

Selecting the folder

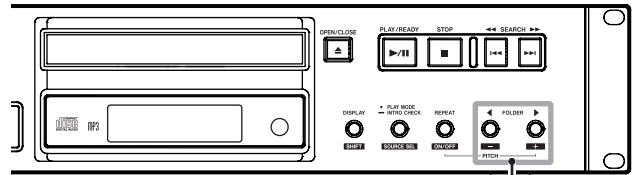

FOLDER \lll/\ggg [PITCH -/+] keys

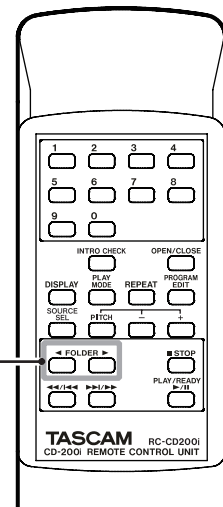

FOLDER \lll/\ggg keys

When using a data CD, by pressing the FOLDER \lll/\ggg (PITCH -/+) keys on the main unit or the FOLDER \lll/\ggg keys on the remote control, you can skip to the previous or next folder. This will skip to the beginning of the first track in the previous or next folder. If you hold down one of these keys, you can skip through folders continually.

NOTE

- When you skip to a different folder, it becomes the current folder.
- During folder playback, REPEAT ALL plays back all tracks inside the current folder repeatedly.
- During folder playback, SHUFFLE plays back all tracks inside the current folder randomly.
- During folder playback, only tracks in the current folder can be included in a program.

4 – Playing Back CDs

Playback modes

This unit can play tracks using three types of playback modes.

Continuous playback (default setting)

The tracks on a disc are played back in numerical order.

NOTE

In folder playback mode, the tracks in the current playback folder on a data CD are played back in numerical order.

Shuffle playback

The tracks on the disc are played back in random order regardless of their track numbers. Playback stops after all tracks have been played once.

NOTE

In folder playback mode, the tracks in the playback folder on a data CD are played back in random order. See "Folder playback (with data CDs only)" on page 24 for details.

Programmed playback

Tracks are played back in the programmed order. See "Programmed playback" on page 25 for details.

Select the playback mode

Press the **PLAY MODE/INTRO CHECK (SOURCE SEL)** key on the main unit or the **PLAY MODE** key on the remote control to cycle through the playback modes.

During playback, however, only continuous playback and shuffle playback modes can be set.

To select programmed playback, press the **PLAY MODE/INTRO CHECK (SOURCE SEL)** key on the main unit or the **PLAY MODE** key on the remote control when playback is stopped or no CD is loaded.

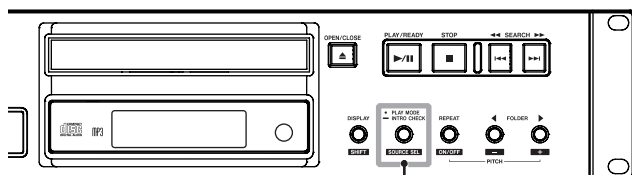

PLAY MODE/INTRO CHECK (SOURCE SEL) key

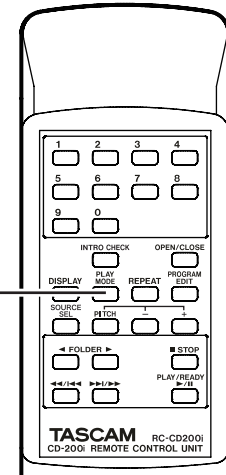

PLAY MODE key

An indicator for the current mode will appear on the display as shown below.

Display	Playback mode
No indication	Continuous playback
SHUFFLE	Shuffle playback
MEMORY	Programmed playback

The selected playback mode is retained even when the power is turned off.

NOTE

Immediately after pressing the PLAY MODE/INTRO CHECK (SOURCE SEL) key on the main unit or the PLAY MODE key on the remote control, the selected mode is shown on the main display area as follows.

Continuous playback mode set: CONTINUE

Shuffle playback mode set: SHUFFLE

Programmed playback mode set: PROGRAM

Programmed playback

To use programmed playback, you must set a program either before or after setting the playback mode to programmed playback mode. (See "Select the playback mode" on page 25.)

When in programmed playback mode, press the **PLAY/READY** key on the main unit or the remote control to start playback of the set program in order from the first track (program step 01). Press a **SEARCH** \lll/\ggg (\lll/\ggg) key on the main unit or a search (\lll/\ggg , \ggg/\lll) key on the remote control to skip to the previous or next program step.

In programmed playback mode, when playback is stopped the total number of tracks in the program and the total program time are shown (total program time is not shown when using a data CD).

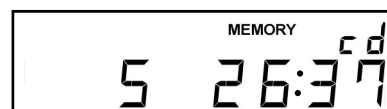

4 – Playing Back CDs

NOTE

- To select programmed playback, press the **PLAY MODE/INTRO CHECK (SOURCE SEL)** key on the main unit or the **PLAY MODE** key on the remote control when playback is stopped or no CD is loaded.
- During folder playback, only tracks in the current folder can be included in a program.

Setting the program

When no program is set, follow the procedures below to set a program using the remote control.

NOTE

- The program cannot be set from the main unit.
- You can set a program at any time regardless of the current playback mode.
- The program is cleared when the disc tray is opened.

- 1 Press the **PROGRAM EDIT** key while playback is stopped.

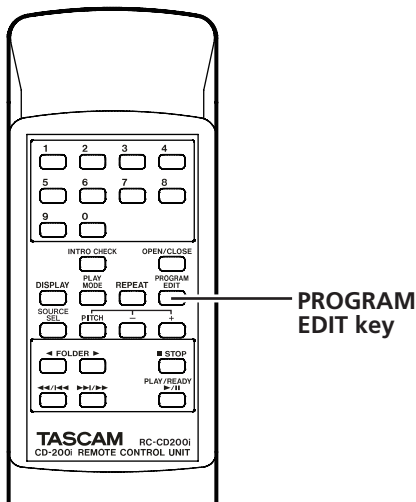

The unit enters program setting mode, and if no program has been set, it will be possible to set a track to program step 01 (**MEMORY** indicator blinks).

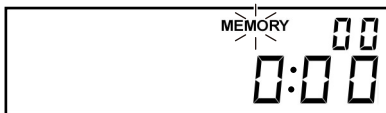

[Audio CD]



[Data CD]

NOTE

If the program is already set, the track number and playback time of the track set as program step 01 is shown.

- 2 Use the numeric keys or search (**◀◀/|◀◀**, **▶▶/|▶▶**) keys to select a track to set as program step 01. (The **MEMORY** indicator and the track number blink.) When using the numeric keys, input the number starting with the leftmost digit.

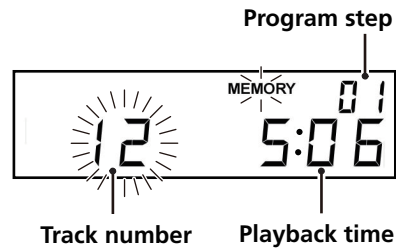

[Audio CD]

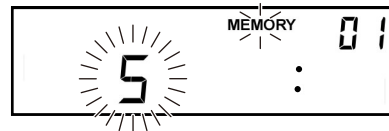

[Data CD]

NOTE

- When using a data CD, the screen switches to file name display if more than a second passes after pressing a numeric key or search (**◀◀/|◀◀**, **▶▶/|▶▶**) key, but it is still possible to add the track to the program.
- If you press the **STOP** key while a track is selected, selection of that track is canceled, and the screen returns to the state where you can select a track.

- 3 Press the **PROGRAM EDIT** key.

The selected track is added to program step 01. The unit is now ready for you to add another track for the next program step.

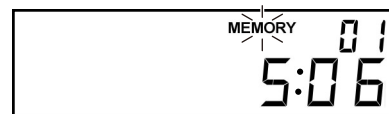

- 4 By repeating steps two and three above, you can add more tracks sequentially as desired.
- 5 If you are finished adding tracks to the program, press the **PROGRAM EDIT** key when the empty program step where it is possible to add a track appears. The unit exits program setting mode.

NOTE

- The same track can be added to the program multiple times.

4 – Playing Back CDs

- If you press the STOP key when the empty program step where it is possible to add a track appears, all steps in the program are cleared.
- If you try to add more than 99 tracks, a “PGM FULL” error message appears. Only 99 tracks can be added.

Checking the program

You can check the contents of the program.

- 1 Press the PROGRAM EDIT key on the remote control while playback is stopped to put the unit into program setting mode.

The track number and playback time of the track set as program step 01 is shown on the screen (playback time is not displayed if the loaded disc is a data CD) and MEMORY blinks.

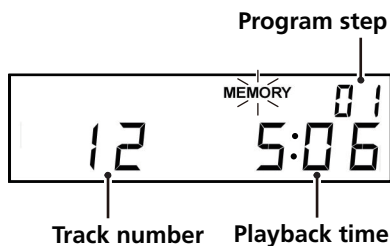

- 2 Press the PROGRAM EDIT key to show the track information of the next program step.



- 3 If you press the PROGRAM EDIT key when the final program step is shown, it becomes possible to add another program step. (No track number is displayed and the MEMORY indicator blinks.)

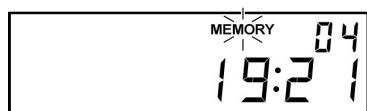

- 4 Press the PROGRAM EDIT key again to exit the program setting mode.

Replacing a program track

You can replace a track that has already been added to the program.

- 1 Press the PROGRAM EDIT key on the remote control while playback is stopped to put the unit into program mode.
- 2 Follow the steps in “Checking the program” above and press the PROGRAM EDIT key to show the program step with the track that you want to replace.
- 3 Use the numeric keys or skip (◀◀/|◀◀, ▶▶/|▶▶) keys to select the desired track and press the PROGRAM EDIT key.

After replacing a track, the display shows the empty step at the end of the program and you can add another track to the end of the program if desired.

4. Press the PROGRAM EDIT key again to exit program setting mode.

Adding more program tracks

You can add tracks to the end of an already set program.

1. Press the PROGRAM EDIT key on the remote control while playback is stopped to put the unit into program setting mode.
- 2 Press the PROGRAM EDIT key until the empty program step where it is possible to add a track appears. (No track number is displayed and the MEMORY indicator blinks.)
- 3 Use the numeric keys or skip (◀◀/|◀◀, ▶▶/|▶▶) keys to select a track and press the PROGRAM EDIT key.
- 4 In this state, you can repeat step 3 to add more tracks, or you can press the PROGRAM EDIT key to exit program setting mode.

CAUTION

- Although tracks can be added to the end of a program and tracks can be replaced with different tracks, tracks cannot be inserted into the middle of a program.
- If you want to insert a track into the middle of the program, replace and add program tracks to alter the program contents.

Clearing the program

You can clear the entire program that has been set.

- 1 Press the PROGRAM EDIT key on the remote control while playback is stopped to put this unit into program setting mode.
- 2 Press the PROGRAM EDIT key until the empty program step appears. (No track number is displayed and MEMORY blinks.)
- 3 Press the STOP key. “-CLEAR-” appears on the display. After the program is cleared, program setting mode resumes without any tracks added to the program.



NOTE

In addition to the above procedure, opening the disc tray also clears the program.

4 – Playing Back CDs

Repeat playback

You can play a selected track or all tracks repeatedly.

Press the REPEAT (PITCH ON/OFF) key on the main unit or the REPEAT key on the remote control to select from one of the following repeat modes.

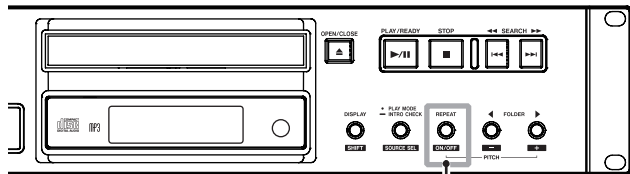

REPEAT (PITCH ON/OFF) key

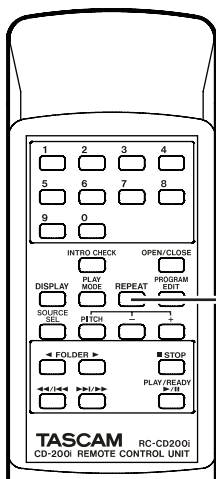

REPEAT key

Single repeat (REPEAT indicator appears):

The selected track is played back repeatedly.

All repeat (REPEAT and ALL indicators appear):

All tracks* are played back repeatedly.

* When set to folder playback with a data CD, all tracks in the folder are repeated. When using programmed playback, all tracks in the program are repeated.

Off (no indicator on the display):

Repeat playback is OFF.

Turning repeat playback OFF:

Press the REPEAT key on the main unit or the remote control until the ALL and REPEAT indicators do not appear.

NOTE

- If single repeat playback is turned ON during playback, the current track is played back repeatedly. If all repeat playback is turned ON during playback, playback continues as it is until the end of the disc or current folder is reached. Then, playback continues from the beginning of the disc or current folder. If repeat playback is turned ON when stopped, repeat playback begins when the PLAY/READY key is pushed.

- The repeat function's ON/OFF state is retained even when the power is turned OFF.
- During folder playback, REPEAT ALL plays back all tracks inside the current folder repeatedly.
- You can use the shuffle and the repeat at the same time.
- You can use the programmed playback and the repeat at the same time.
- You can change the setting of repeat playback during playback.

Time and text information display

You can set what type of time and text information is shown on the display.

Press the DISPLAY (SHIFT) key on the main unit or the DISPLAY key on the remote control to show for two seconds the type of information (playback time or text information) that is currently set to appear in the main area of the display. Press this key again while this is being shown to change the type of information displayed.

The contents that can be displayed differ depending on the type of disc loaded, its status and the operation state of the unit.

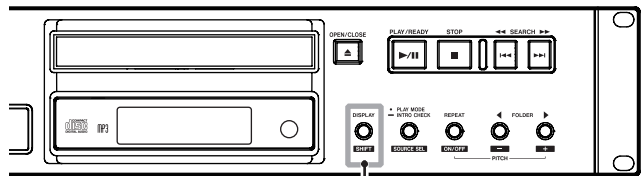

DISPLAY (SHIFT) key

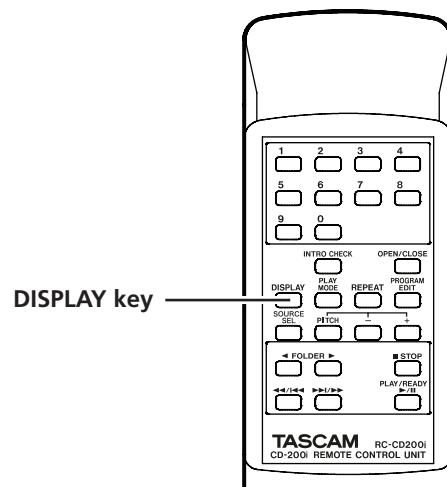

DISPLAY key

4 – Playing Back CDs

Audio CDs with CD text

When stopped, the display cycles through total time, album title and album artist. When playing back or paused, the display cycles through track elapsed time, track remaining time, total remaining time, track title and track artist.

Audio CDs without CD text

When stopped, playback time is displayed. When playing back or paused, the display cycles through track elapsed time, track remaining time and total remaining time.

Data CDs

When stopped, the display switches between total number of tracks and album title (current folder). When playing back or paused, the display cycles through track elapsed time, title, artist and file.

NOTE

- After pressing the **DISPLAY (SHIFT)** key on the main unit or the **DISPLAY** key on the remote control, the currently selected type of information to be shown on the main display appears for two seconds as follows.
 - Track elapsed time: *ELAPSED*
 - Track remaining time: *REMAIN*
 - Total remaining time: *T REMAIN*
 - Album/track title: *TITLE*
 - Album/track artist: *ARTIST*
 - File name: *FILENAME*
- The text information that can be shown on the display is ID3 tag information for data CDs and CD text information for audio CDs. When this information is not included for a disc or file or the information contains characters that cannot be displayed, "NO TITLE" (title information) or "NO NAME" (artist information) is shown.
- When an audio CD is in programmed playback mode the elapsed time and remaining time of the entire program is shown.
- The display contents setting is retained even when the power is turned off.

Pitch control

Using pitch control playback, CDs can be played back at a different pitch (sound frequency and playback speed).

Follow the procedures below to use pitch control playback.

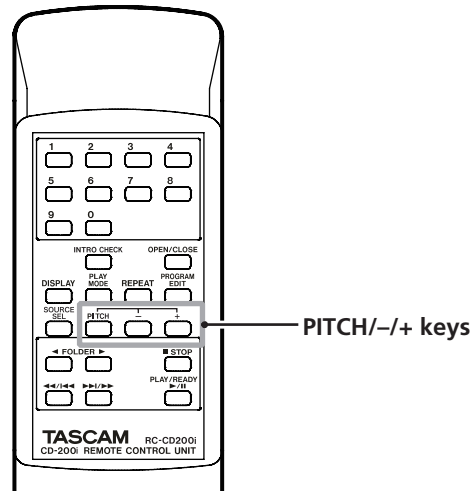
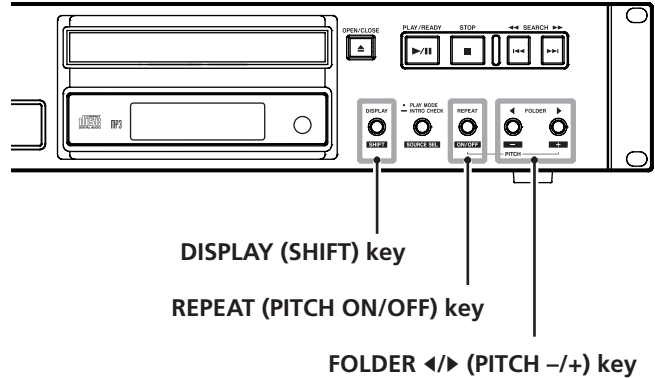

- 1 Press the **REPEAT (PITCH ON/OFF)** key while pressing and holding the **DISPLAY (SHIFT)** key on the main unit or press the **PITCH** key on the remote control to turn pitch control ON.

The current pitch control value is shown at this time.



- 2 Use the **FOLDER </> (PITCH -/+)** keys on the main unit or the **PITCH -/+** key on the remote control to set the pitch in 0.5% units in a range of $\pm 14.0\%$.

- To turn pitch control playback OFF:

Press the **REPEAT (PITCH ON/OFF)** key while pressing and holding the **DISPLAY (SHIFT)** key on the main unit or press the **PITCH** key on the remote control.



4 – Playing Back CDs

CAUTION

- During playback, turning pitch control playback ON or OFF might cause the playback sound to skip momentarily.
- Using pitch control playback with a data CD (MP3, WAV) sometimes causes the playback sound to skip.
- Digital output is possible when the pitch control function is ON during playback of MP3 and WAV files on audio CDs, but the sampling frequency is changed by an amount proportional to the pitch control value. When pitch control is ON, therefore, some equipment might not be able to receive the digital output signal from the CD-200i.
- The pitch control function cannot be used with iPods.

Intro Check

During playback or when stopped, press and hold the PLAY MODE/INTRO CHECK (SOURCE SEL) key on the main unit or the INTRO CHECK key on the remote control to playback only the first 10 seconds of each track.

The **INTRO** indicator lights when this function is ON.

When Intro Check is ON, press and hold the PLAY MODE/INTRO CHECK (SOURCE SEL) key on the main unit or the INTRO CHECK key on the remote control again to return to the continuous playback mode and turn the **INTRO** indicator OFF.

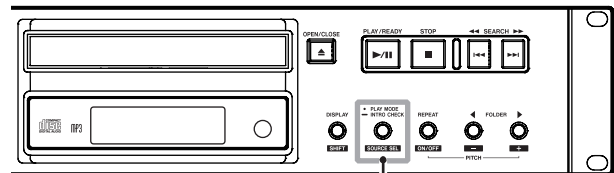

PLAY MODE/INTRO CHECK (SOURCE SEL) key

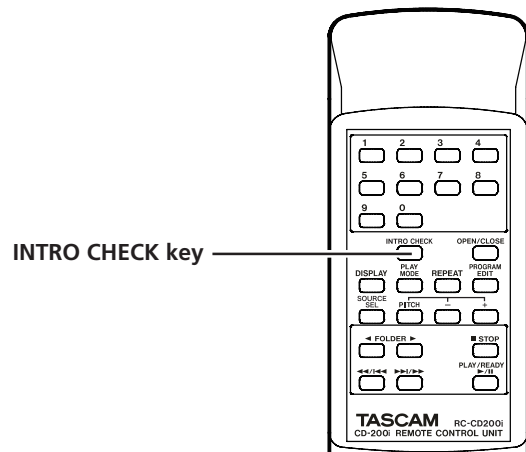

INTRO CHECK key

- When using Intro Check, press the SEARCH <</>> (|<</>>|) keys on the main unit or the search (<</|<<, >>|>>) keys on the remote control to skip to the preceding or next track.
- Press the STOP key to stop Intro Check.

NOTE

- The intro check function can be used with data CDs.
- The intro check function can be used during program and folder playback modes.
- The intro check function cannot be used with iPods.

5 – iPod Playback

By connecting an iPod with the iPod dock on the front panel, this unit can control the iPod and output its sound/video. Moreover, it can also recharge the iPod when this unit's power is ON.

iPod dock

Connect an iPod following the instructions on page 16. Always attach a dock adapter suitable for your iPod to the connector. Dock adapters are not included with this product. Use the dock adapter included with your iPod or a commercially available Apple iPod Universal Dock Adapter made by Apple Inc.

- Read the instructions on page 16 carefully and proceed with caution in order to avoid damage to the connectors and sudden bursts of noise when connecting and disconnecting an iPod.
- See our website (<http://www.tascam.com/>) for information about compatible devices.

Controlling an iPod

The following keys on the CD-200i front panel and remote control (RC-CD200i) can be used to control the iPod.

PLAY/READY key (▶/||): Play/Pause

STOP key (■): Pause

SKIP keys (◀◀/|◀◀, ▶▶/|▶▶): Previous and Next (press and hold for Rewind and Fast-forward)

FOLDER keys (◀/▶): Skip through albums

REPEAT key: Cycle through repeat single track, repeat all tracks and repeat off modes

PLAY MODE key: Cycle through continuous, song shuffle and album shuffle playback modes

DISPLAY key: Sets whether the iPod video is shown on the iPod itself or output from this unit's **VIDEO OUT** jack

CAUTION

Depending on the iPod software version, operation from the CD-200i might not work.

Settings made on the iPod

Make the following settings on the iPod in order to output video. These settings cannot be made from the CD-200i.

- TV Signal setting (NTSC or PAL)
- TV Screen (or Widescreen) setting

iPod playback

1. Press the **PLAY MODE/INTRO CHECK (SOURCE SEL)** while pressing and holding **DISPLAY (SHIFT)** key at the same time, or press the **SOURCE SEL** on

the remote control, and set the output sound source to iPod.

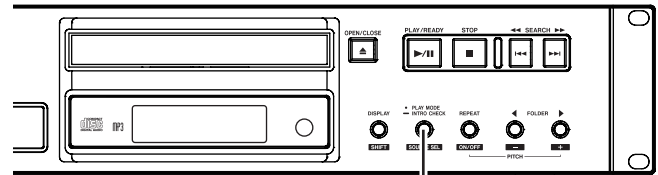

PLAY MODE/INTRO CHECK (SOURCE SEL) key

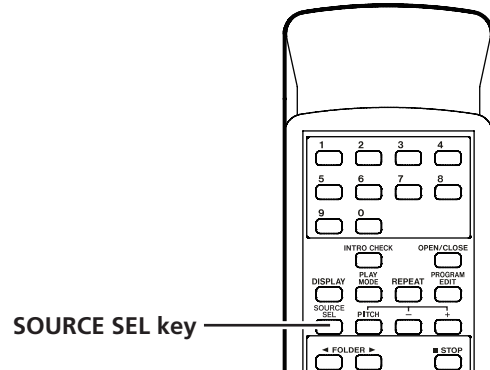

SOURCE SEL key

Doing this makes it possible to control the iPod from the CD-200i front panel and remote control (RC-CD200), as well as to output the iPod's sound and video signals.

Setting the iPod video output

When iPod is selected, you can use the **DISPLAY** key on the main unit or the remote control to switch whether its video is shown on the iPod itself or output through this unit's **VIDEO OUT** jack.

You cannot, however, switch the video output destination during video playback. Switch it while the iPod is stopped or stop the playback once and then switch it if the iPod is already playing back.

If switched during video playback, the new output destination is used when playback is stopped then started again.



[Video Out: iPod]



[Video Out: CD-200i VIDEO OUT]

NOTE

- When **VIDEO ON** is selected, the iPod video signal is always transmitted from this unit's video outputs, regardless of the selected (audio) output source.
- When playing the video clip by iPod Touch, pressing the **DISPLAY** key stops the video playback.

6 – Message Lists

Operation messages

The following messages are shown on the main display according to the operation of the CD player.

Message	Message lit or blinking	Meaning	Response
-CLEAR-	Lit	All programs have been cleared.	
CLOSE	Lit	The disc tray is closing.	
NO DISC	Lit	There is no disc or the disc cannot be verified.	
NO FILES	Lit	The disc has no files that can be played back.	Load a disc that has MP3 or WAV files.
NO NAME	Lit	There is no artist data or no file data that can be displayed	Text information must be 7-bit ASCII compatible text to be displayed.
NO TITLE	Lit	There is no title data that can be displayed.	Text information must be 7-bit ASCII compatible text to be displayed.
OPEN	Lit	The disc tray is open.	
TOC READ	Lit	TOC information is being read.	
NO IPOD	Lit	No iPod is connected.	Connect an iPod.
-IPOD-	Lit	The output source is set to iPod.	
-AUX-	Lit	The output source is set to AUX.	

Warning messages

If an operation cannot be completed, one of the following messages is shown. It will appear for about two seconds before disappearing automatically.

Message	Message lit or blinking	Meaning	Response
NO PGM	Lit	No program has been created.	Add tracks to the program.
PGM FULL	Lit	You cannot add more than 99 tracks to the program.	Either stop trying to add to the program, clear the program, or replace one of the tracks in the program.

Error messages

If one of the following error messages is shown, please refer to the Response column and try to resolve it. If this does not correct the problem, please contact a TEAC repair center.

Message	Message lit or blinking	Meaning	Response
COMM ERR	Blinking	Cannot communicate with the CD drive.	Contact a TEAC repair center.
COMM ERR	Lit	An error occurred during communication with the CD drive.	Contact a TEAC repair center.
DEC ERR	Lit	The file type is not supported or otherwise could not be played	Change the disc
DISC ERR	Lit	The TOC or file system could not be read, or focus adjustment was not possible.	Clean or change the disc.
DRV ERR	Lit	The CD drive hardware is broken.	Contact a TEAC repair center.
READ ERR	Lit	The track cannot be accessed.	Clean or change the disc.

7 – Troubleshooting

If you have problems with your system, look through this chart and see if you can solve the problem yourself before calling your dealer or TEAC service center.

■ No power

➔ Is the unit's power plug completely inserted into a working power outlet?

■ Remote control doesn't work.

➔ Check to see if the batteries are properly installed in the remote control.

➔ If the batteries are dead, change the batteries.

■ No sound

➔ Check the connection to the monitor system again.

➔ Check the volume and settings of the amplifier.

■ There is unwanted noise.

➔ Are the connecting cables all properly connected and functioning?

■ A CD cannot be played back.

➔ If you are using a data CD with MP3 files, confirm that the file bit-rates are compatible with this unit.

➔ Is the disc scratched or dirty?

■ The files on a data CD cannot all be played back.

➔ Is the unit in folder playback mode?

■ The iPod cannot be connected to the iPod dock.

➔ Confirm that the correct dock adapter has been inserted into this unit's iPod dock.

➔ Confirm that no debris or dust is stuck to this unit's iPod dock and then try to connect the iPod again.

■ The iPod cannot be controlled.

➔ Is the iPod connected correctly with the unit's dock connector?

➔ Is the unit's power plug completely inserted into a working power outlet?

➔ Is the iPod selected as the output source?

➔ Unlock the HOLD switch on the iPod.

➔ Remove the iPod from the iPod dock once and then wait a moment before reconnecting the iPod.

➔ Updating the iPod software frequently resolves problems. Please visit Apple's website and check for the latest information.

■ There is no sound or video from the iPod.

➔ Is the iPod playing?

➔ Is the iPod connected correctly with the unit's dock connector?

➔ Is the unit's power plug completely inserted into a working power outlet?

➔ Is the video or S-video cable correctly connected?

➔ Is the television input set to the video input jack to which this unit is connected?

➔ Are the iPod video output and television output settings matched correctly (NTSC or PAL)?

8 – Specifications

Ratings

■ Compatible disc formats

CD-DA (12-cm/8-cm), CD-ROM (12-cm/8-cm) ISO 9660 LEVEL 1/2/ROMEO/JOLIET format (CD-R/CD-RW DISC compatible)

■ Playable format

Audio CD (CD-DA),
MPEG1 Audio Layer III (MP3)
WAV

■ MP3 playback specifications

Audio Mode: STEREO/JOINT STEREO/DUAL CHANNEL/MONO
Sampling Frequency: 32 kHz/44.1 kHz/48 kHz
Bit Rate: 32 kbps - 320 kbps, and VBR

■ WAV playback specifications

Sampling Frequency: 8 kHz/11.025 kHz/12 kHz/16 kHz/22.05 kHz/24 kHz/32 kHz/44.1 kHz/48 kHz
Sampling Bit Rate: 8 bit/16 bit

■ Audio CD playback specifications

Sampling Frequency: 44.1 kHz
Sampling Bit Rate: 16 bit
Number of Channels: 2

Input/Output ratings

■ AUX IN (UNBALANCED) Jack

Connector: 3.5 mm stereo mini jack
Reference Input Level: -16 dBV
Maximum Input Level: 0 dBV
Input impedance: 22 k Ω

■ ANALOG OUTPUT (UNBALANCED) Terminal

Connector: RCA pin jack
CD Reference Output Level: -10 dBV
CD Maximum Output Level: +6 dBV
Output Impedance: 200 Ω

■ PHONES Jack

Connector: Standard Stereo Jack
Maximum Output Level: 20 mW + 20 mW
Load Impedance: 32 Ω

■ DIGITAL OUTPUT (OPTICAL) Terminal

Connector: Optical Jack
Compatible Signal Format: IEC-60958 Type II (S/PDIF)

■ DIGITAL OUTPUT (COAXIAL) Terminal

Connector: RCA Pin Jack
Compatible Signal Format: IEC-60958 Type II (S/PDIF)

■ Video Output

Connector: RCA Pin Jack
Compatible Signal Format: Composite video signal
Output Impedance: 75 Ω

■ S-VIDEO Output

Connector: 4-pin mini-DIN connector
Compatible Signal Format: Separate video signal

Audio performance (CD playback)

Frequency Response: 20 Hz - 20 kHz \pm 1.5 dB
Signal-to-Noise Ratio (S/N): More than 90 dB (20 kHz LPF + A-weighted)
Dynamic Range: More than 90 dB (20 kHz LPF + A-weighted)
Total Harmonic Distortion: Less than 0.01% (1 kHz, 20 kHz LPF)
Channel Separation: More than 90 dB (1 kHz, 1 kHz BPF)

Backup memory

The following settings are backed up even when the unit power is turned off. “(CD)” means that the settings are backed up when the output source is set to CD.

- Time and title display settings (CD)
- Playback mode (CD)
- Program (for loaded CD)
- Current folder (for loaded CD)
- Output source setting
- Repeat setting (CD)
- Pitch control ON/OFF (CD)
- Pitch control value (CD)

8 – Specifications

General

■ Power Requirement

AC 120 V, 60 Hz (U.S.A./Canada)

AC 230 V, 50 Hz (U.K./Europe)

AC 240 V, 50 Hz (Australia)

■ Power Consumption

12 W

■ Dimensions (W x H x D)

481 x 94.5 x 298 (mm) / 18.94 x 3.72 x 11.73 (in)

■ Weight

4.7 kg (10.36 lb)

■ Operating Temperature

5 to 35°C

■ Inclination of installation

5° or less

Dimensions

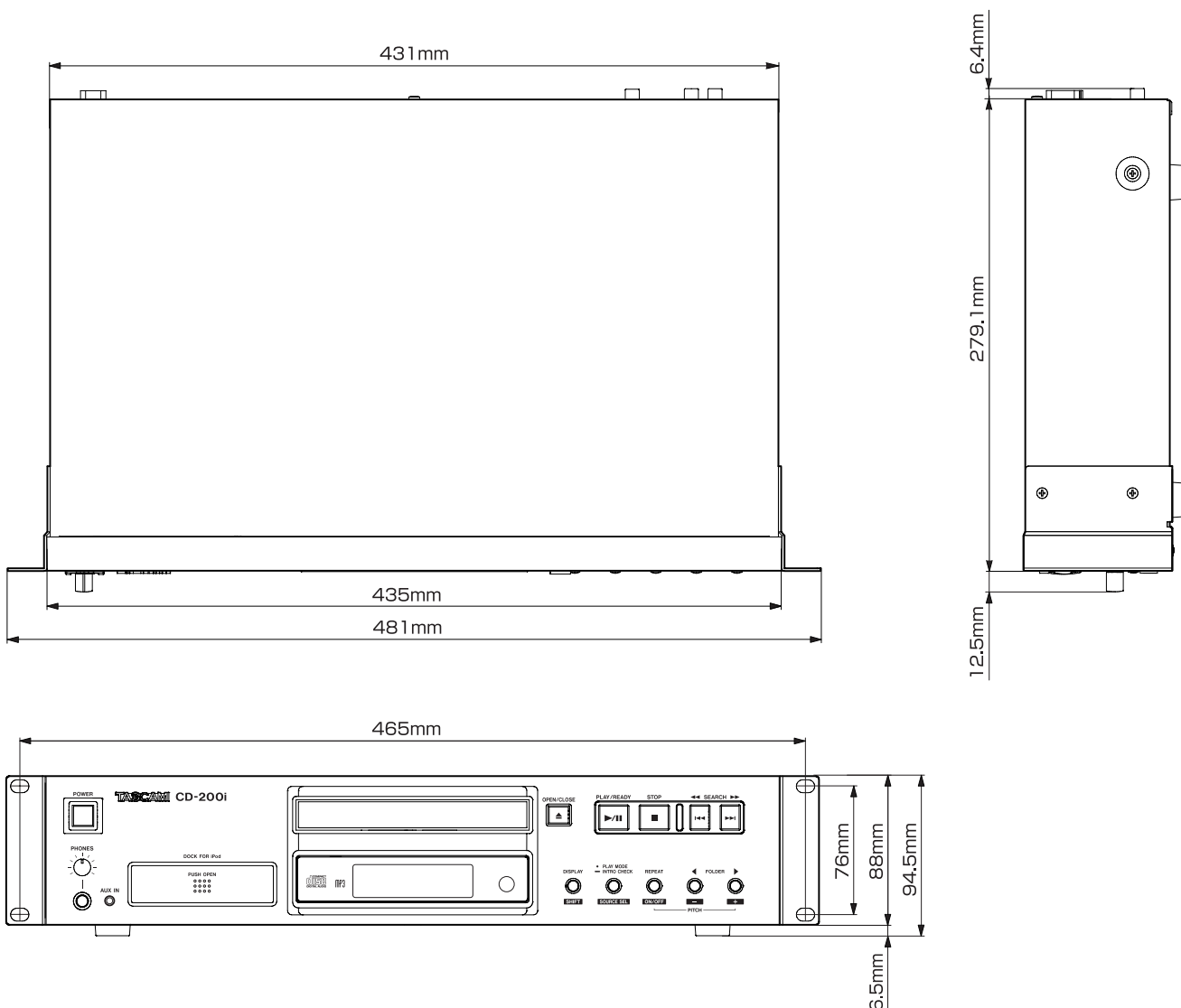

- Illustrations and other depictions may differ in part from the actual product.
- Specifications and external appearance may be changed without notification to improve the product.

TASCAM[®]
TEAC PROFESSIONAL

CD-200i

TEAC CORPORATION

Phone: +81-42-356-9143
1-47 Ochiai, Tama-shi, Tokyo 206-8530, Japan

www.tascam.jp

TEAC AMERICA, INC.

Phone: +1-323-726-0303
7733 Telegraph Road, Montebello, California 90640 USA

www.tascam.com

TEAC CANADA LTD.

Phone: +1905-890-8008 Facsimile: +1905-890-9888
5939 Wallace Street, Mississauga, Ontario L4Z 1Z8, Canada

www.tascam.com

TEAC MEXICO, S.A. de C.V.

Phone: +52-55-5010-6000
Río Churubusco 364, Colonia Del Carmen, Delegación Coyoacán, CP 04100, México DF, México

www.teacmexico.net

TEAC UK LIMITED

Phone: +44-8451-302511
Suites 19 & 20, Building 6, Croxley Green Business Park, Hatters Lane, Watford, Hertfordshire, WD18 8TE, UK

www.tascam.co.uk

TEAC EUROPE GmbH

Phone: +49-611-71580
Bahnstrasse 12, 65205 Wiesbaden-Erbenheim, Germany

www.tascam.de