



# Table of Contents

Table of Contents .....	1
Usage Notice.....	2
Safety Information .....	2
Precautions.....	3
Eye Safety Warnings .....	5
Product Features .....	5
Introduction.....	6
Package Overview.....	6
Product Overview .....	7
Main Unit.....	7
Control Panel .....	8
Input / Output Connections .....	9
Remote Control.....	11
Installation .....	12
Connecting the Projector.....	12
Connect to Computer/Notebook .....	12
Connect to Video Sources .....	13
Powering On/Off the Projector.....	15
Powering On the Projector.....	15
Powering Off the projector .....	16
Warning Indicator.....	16
Adjusting the Projected Image.....	17
Adjusting the Projector's Height.....	17
Adjusting the Projector's Zoom / Focus .....	18
Adjusting Projected Image Size .....	18
Adjusting Projected Image Position Using PureShift .....	19
User Controls .....	21
Control Panel & Remote Control .....	21
Control Panel .....	21
Remote Control.....	22
Using the USB Remote Mouse Control .....	24
Using the ENTER / HELP button .....	24
On-screen Display Menus .....	27
How to operate .....	27
Menu Tree.....	28
Image .....	29
Display .....	32
Setup.....	37
Options.....	49
Appendices.....	52
Troubleshooting.....	52
Image Problems .....	52
Other Problems .....	55
Projector Status Indication .....	55
Remote Control Problems .....	56
Replacing the Lamp.....	57
Compatibility Modes .....	59
RS232 Commands .....	60
Ceiling Mount Installation .....	63
Optoma Global Offices .....	64
Regulation & Safety notices .....	66
Wireless.....	68

## Safety Information

	The lightning flash with arrow head within an equilateral triangle is intended to alert the user to the presence of uninsulated "dangerous voltage" within the product's enclosure that may be of sufficient magnitude to constitute a risk of electric shock to persons.
	The exclamation point within an equilateral triangle is intended to alert the user to the presence of important operating and maintenance (servicing) instructions in the literature accompanying the appliance.

**WARNING:** TO REDUCE THE RISK OF FIRE OR ELECTRIC SHOCK, DO NOT EXPOSE THIS APPLIANCE TO RAIN OR MOISTURE. DANGEROUS HIGH VOLTAGES ARE PRESENT INSIDE THE ENCLOSURE. DO NOT OPEN THE CABINET. REFER SERVICING TO QUALIFIED PERSONNEL ONLY.

### Class B emissions limits

This Class B digital apparatus meets all requirements of the Canadian Interference-Causing Equipment Regulations.

### Important Safety Instruction

1. Do not block any ventilation openings. To ensure reliable operation of the projector and to protect from over heating, it is recommended to install the projector in a location that does not block ventilation. As an example, do not place the projector on a crowded coffee table, sofa, bed, etc. Do not put the projector in an enclosure such as a book case or a cabinet that restricts air flow.
2. Do not use the projector near water or moisture. To reduce the risk of fire and/or electric shock, do not expose the projector to rain or moisture.
3. Do not install near heat sources such as radiators, heaters, stoves or any other apparatus such as amplifiers that emits heat.
4. Clean only with dry cloth.
5. Only use attachments/accessories specified by the manufacturer.
6. Do not use the unit if it has been physically damaged or abused.  
Physical damage/abuse would be (but not limited to):
  - Unit has been dropped.
  - Power supply cord or plug has been damaged.
  - Liquid has been spilled on to the projector.
  - Projector has been exposed to rain or moisture.
  - Something has fallen in the projector or something is loose inside.Do not attempt to service the unit yourself. Opening or removing covers may expose you to dangerous voltages or other hazards. Please call Optoma before you send the unit for repair.
7. Do not let objects or liquids enter the projector. They may touch dangerous voltage points and short out parts that could result in fire or electric shock.
8. See projector enclosure for safety related markings.
9. The unit should only be repaired by appropriate service personnel.

## Precautions



*Please follow all warnings, precautions and maintenance as recommended in this user's guide.*

- Warning- Do not look into the projector's lens when the lamp is on. The bright light may hurt your eyes.
- Warning- To reduce the risk of fire or electric shock, do not expose this projector to rain or moisture.
- Warning- Please do not open or disassemble the projector as this may cause electric shock.
- Warning- When replacing the lamp, please allow the unit to cool down. Follow instructions as described on pages 57-58.
- Warning- This projector will detect the life of the lamp itself. Please be sure to change the lamp when it shows warning messages.
- Warning- Reset the "Lamp Reset" function from the on-screen display "Options | Lamp Settings" menu after replacing the lamp module (refer to page 51).
- Warning- When switching the projector off, please ensure the cooling cycle has been completed before disconnecting power. Allow 90 seconds for the projector to cool down.
- Warning- Do not use lens cap when projector is in operation.
- Warning- When the lamp is approaching the end of its lifetime, the message "Replacement suggested" will show on the screen. Please contact your local reseller or service center to change the lamp as soon as possible.
- Warning- To reduce the risk of injury to the eyes, do not look directly into the laser beam on the remote control and do not point the laser beam into anyone's eyes. This remote control is equipped with a Class II laser that emits radiation.



- ❖ When the lamp reaches the end of its life, the projector will not turn back on until the lamp module has been replaced. To replace the lamp, follow the procedures listed under "Replacing the Lamp" section on pages 57-58.

# Usage Notice

## **Do:**

- ❖ Turn off and unplug the power plug from the AC outlet before cleaning the product.
- ❖ Use a soft dry cloth with mild detergent to clean the display housing.
- ❖ Disconnect the power plug from AC outlet if the product is not being used for a long period of time.

## **Do not:**

- ❖ Block the slots and openings on the unit provided for ventilation.
- ❖ Use abrasive cleaners, waxes or solvents to clean the unit.
- ❖ Use under the following conditions:
  - In extremely hot, cold or humid environments.
    - ▶ Ensure that the ambient room temperature is within 5 - 35°C.
    - ▶ Relative Humidity is 5 - 35°C, 80% (Max.), non-condensing.
  - In areas susceptible to excessive dust and dirt.
  - Near any appliance generating a strong magnetic field.
  - In direct sunlight.



## Eye Safety Warnings



- ■ Avoid staring/facing directly into the projector beam at all times. Keep your back to the beam as much as possible.
- ■ When projector is used in a classroom, adequately supervise students when they are asked to point out something on the screen.
- ■ In order to minimize the lamp power, use room blinds to reduce ambient light levels.

## Product Features

- ■ XGA (1024x768) / WXGA (1280x800) Native resolution
- ■ Large Zoom range
- ■ Manual lens shift operation
- ■ Wireless LAN (for wireless model only)

# Introduction

## Package Overview

*Unpack and inspect the box contents to ensure all parts listed below are in the box. If something is missing, please contact your nearest customer service center.*

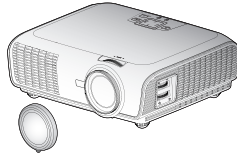

Projector with lens cap

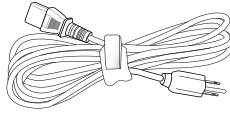

Power Cord 3.0m

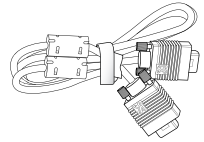

VGA Cable 1.8m

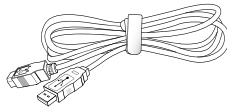

USB Cable 1.8m

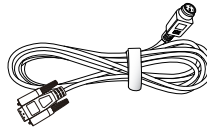

RS232 Cable 1.8m



IR Remote Control



❖ Due to different applications in each country, some regions may have different accessories.

### Documentation :

- User's Manual
- Warranty Card
- Quick Start Card
- WEEE Card  
(for EMEA only)

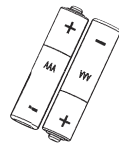

2 × AAA Batteries

## Product Overview

### Main Unit

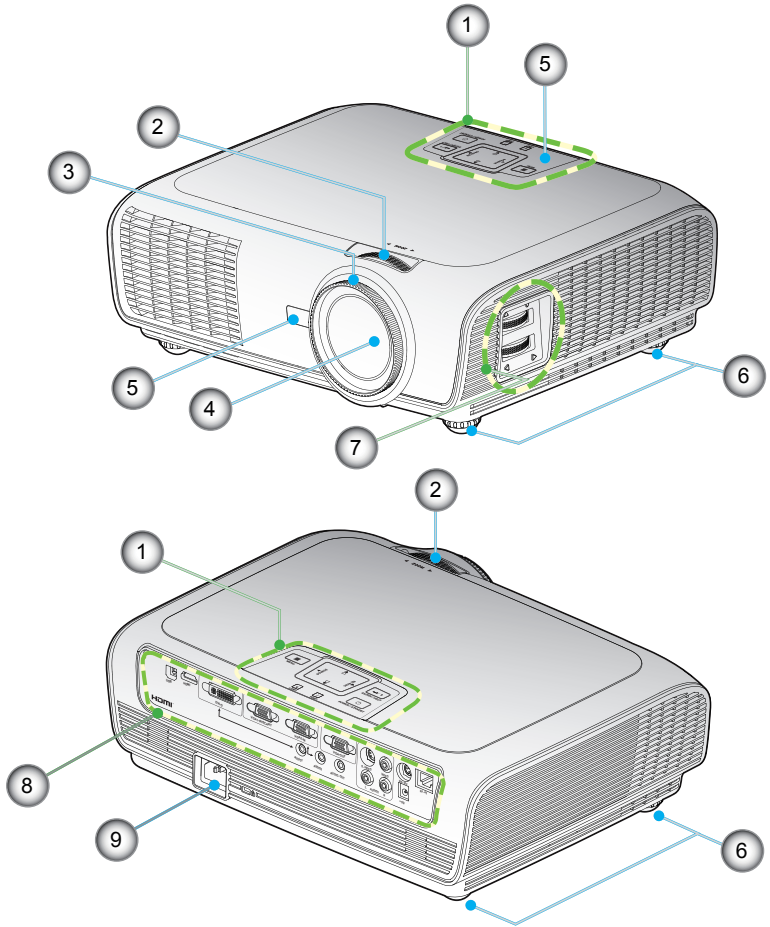

1. Control Panel
2. Zoom Ring
3. Focus Ring
4. Zoom Lens
5. IR Receivers

6. Tilt-Adjustment Feet
7. Lens Shift Adjustment
8. Input / Output Connections
9. Power Socket

# Introduction

## Control Panel

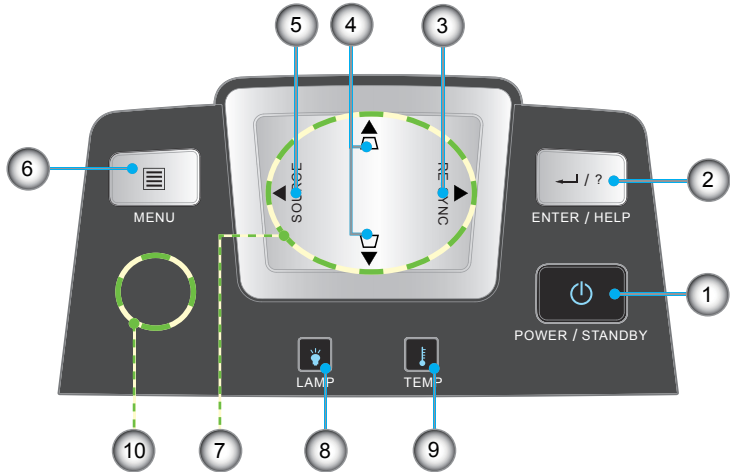

1. Power/Standby and Power LED
2. Enter/Help
3. Re-Sync
4. Keystone Correction
5. Source
6. Menu
7. Four Directional Select Keys
8. Lamp Fail LED
9. Temp LED
10. IR Receiver

# Introduction

## Input / Output Connections

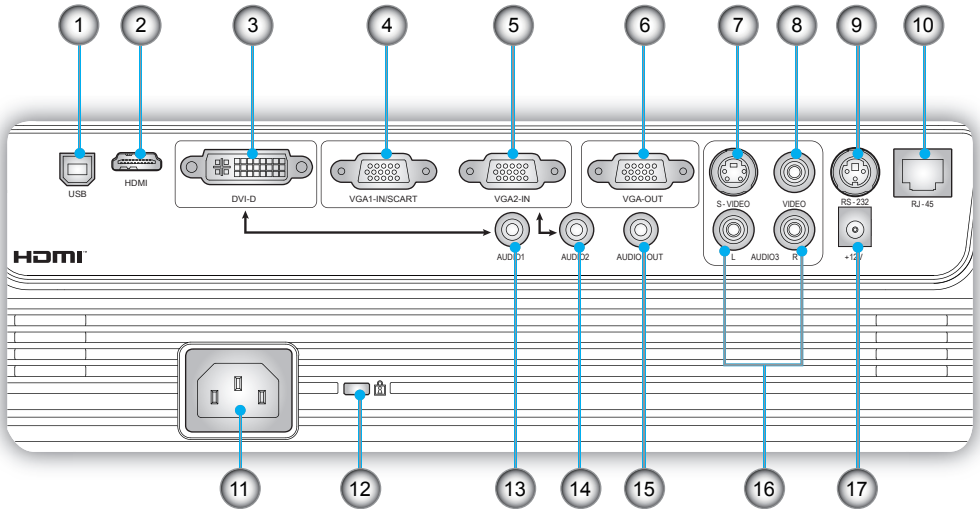

1. USB Connector (Connect to PC for Remote Mouse function)
2. HDMI Connector
3. DVI-D Connector (PC Digital (HDCP))
4. VGA1-In/SCART Connector  
(PC Analog Signal/Component Video Input/HDTV/SCART)
5. VGA2-In Connector  
(PC Analog Signal/Component Video Input/HDTV)
6. VGA-Out Connector (Monitor Loop-through Output)
7. S-Video Input Connector
8. Composite Video Input Connector
9. RS-232 Connector (3-pin)
10. RJ45 Networking Connector
11. Power Socket
12. Kensington™ Lock Port
13. Audio Input 1 (3.5mm Mini Jack) (default for DVI-D)
14. Audio Input 2 (3.5mm Mini Jack) (default for VGA)
15. Audio Output Connector (3.5mm Mini Jack)
16. Audio Input 3 (L/R RCA) (default for S-video & Composite)
17. 12V Trigger Relay Connector

# Introduction

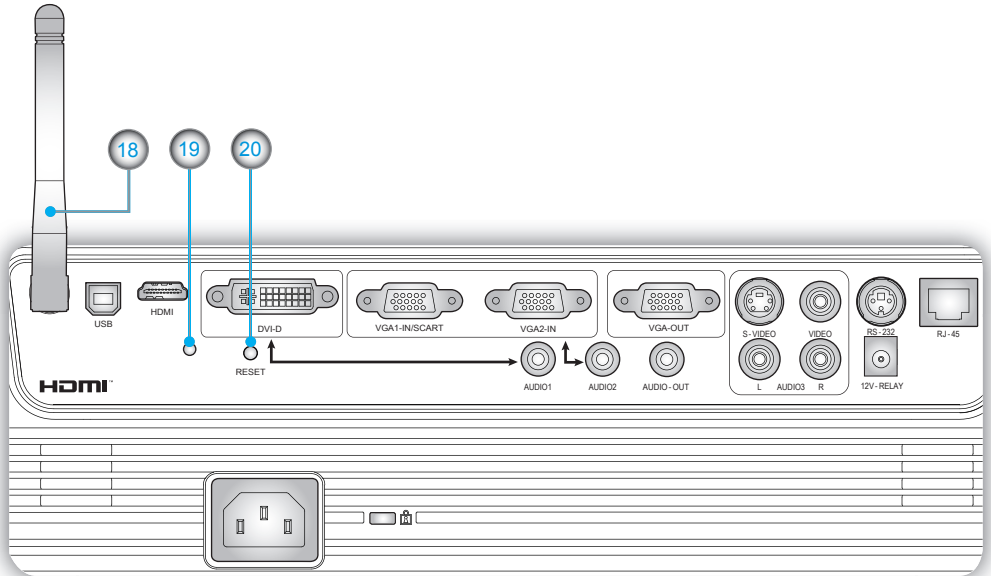

*The items below apply to models with the wireless feature:*

- 18. Antenna
- 19. Status Indicator LED
- 20. Reset button

# Introduction

## Remote Control

1. Indicator LED
2. Power On/Off
3. Laser Pointer
4. Page Up
5. Mouse Right Click
6. Four Directional Select Keys
7. Re-Sync
8. Page Down
9. Volume +/-
10. Zoom
11. HDMI
12. Video
13. VGA-2
14. VGA-1
15. S-Video
16. DVI-D
17. AV mute
18. Menu
19. Keystone +/-
20. Source
21. Enter/Help
22. Mouse Left Click
23. PC/Mouse control
24. Numbered keypad (for password input)
25. Wireless Button (for wireless model only)

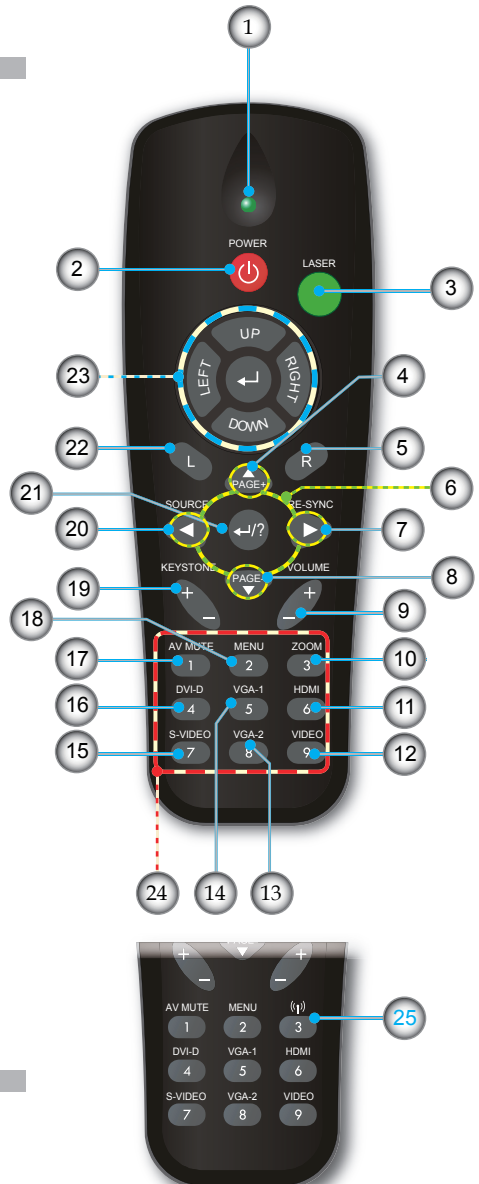

# Installation

## Connecting the Projector

### Connect to Computer/Notebook

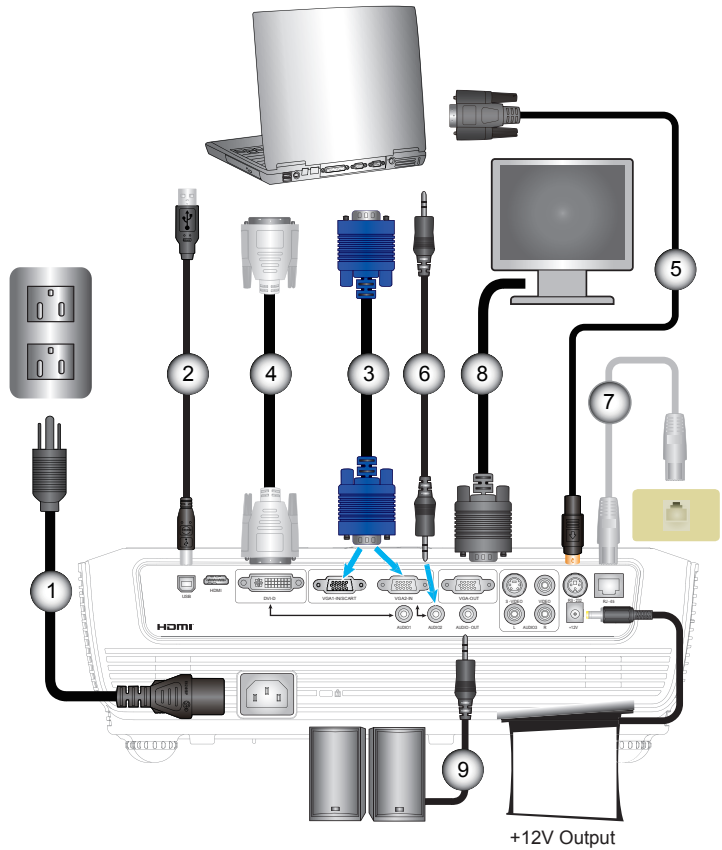

- ❖ Due to the difference in applications for each country, some regions may have different accessories.
- ❖ (\*) Optional accessory

1.....	Power Cord
2.....	USB Cable
3.....	VGA Cable
4.....	*DVI Cable
5.....	RS232 Cable
6.....	*Audio Input Cable
7.....	*Network Cable
8.....	*VGA Output Cable
9.....	*Audio Output Cable



# Installation

## Connect to Video/VGA1-IN/SCART/HDMI

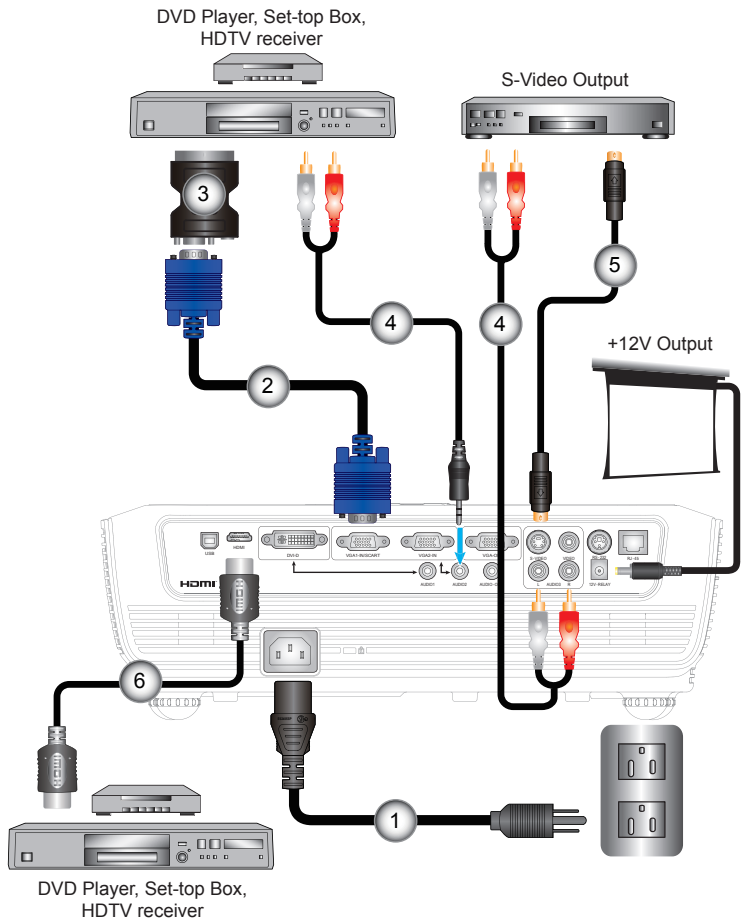

- ❖ Due to the difference in applications for each country, some regions may have different accessories.
- ❖ (\*) Optional accessory

- |        |                       |
|--------|-----------------------|
| 1..... | Power Cord            |
| 2..... | VGA Cable             |
| 3..... | *SCART/VGA Adaptor    |
| 4..... | *Audio Cable Jack/RCA |
| 5..... | *S-Video Cable        |
| 6..... | *HDMI Cable           |

# Installation

## Connect to Video/VGA1-IN/SCART/HDMI

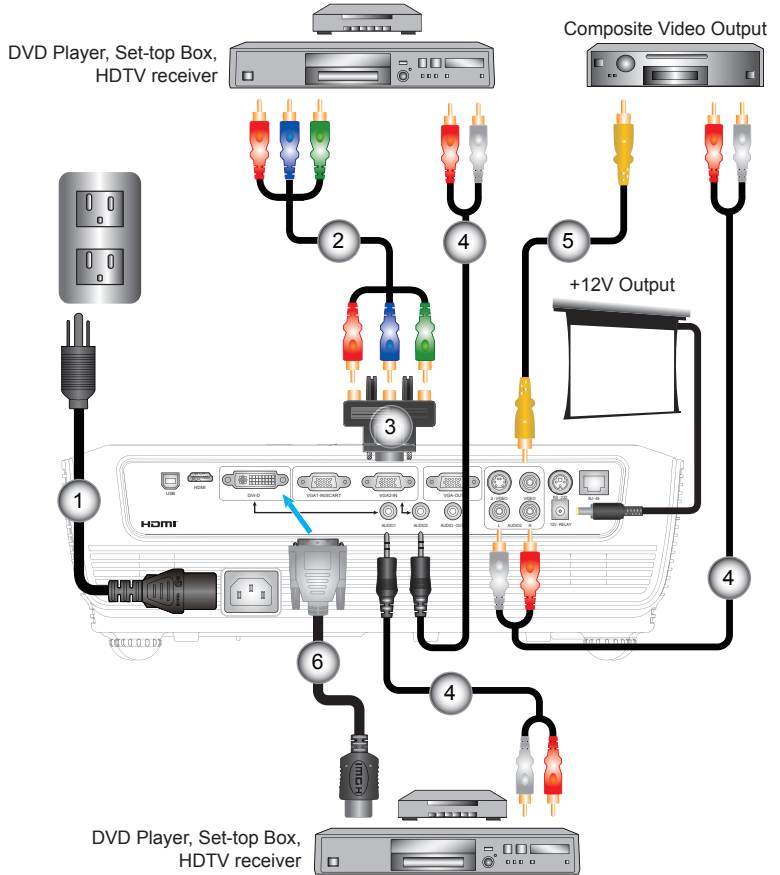

- ❖ Due to the difference in applications for each country, some regions may have different accessories.
- ❖ (\*) Optional accessory

1.....	Power Cord
2.....	*3 RCA Component Cable
3.....	*15-Pin to 3 RCA Component/HDTV Adaptor
4.....	*Audio Cable Jack/RCA
5.....	*Composite Video Cable
6.....	DVI to HDMI Cable

## Powering On/Off the Projector

### Powering On the Projector

1. Remove the lens cap. ❶
2. Securely connect the power cord and signal cable. When connected, the Power LED will turn red.
3. Turn on the lamp by pressing “” button either on the top of the projector or on the remote. The Power LED will now flash Blue. ❷

The startup screen will display in approximately 10 seconds. The first time you use the projector, you can select your preferred language from quick menu after the startup screen displays.

4. Turn on and connect the source that you want to display on the screen (computer, notebook, video player, etc). The projector will detect the source automatically. If not, push menu button and go to “OPTIONS”. Make sure that the “Source Lock” has been set to “Off”.
- ❖ If you connect multiple sources at the same time, press the “SOURCE” button on the control panel or direct source keys on the remote control to switch between inputs.

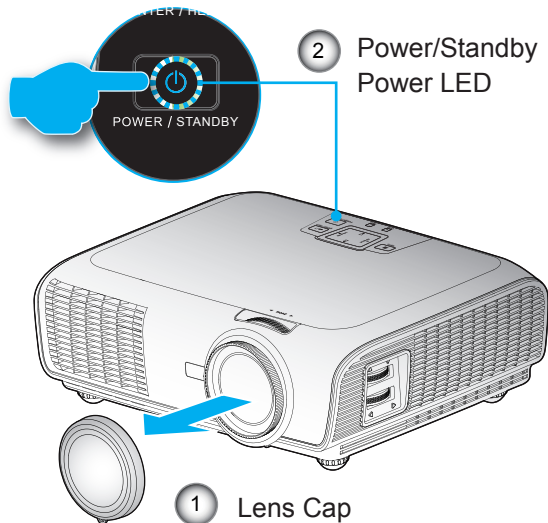

- ❖ Turn on the projector first and then select the signal sources.

## Powering Off the Projector

1. Press the “” button to turn off the projector lamp. The following message will be displayed on the screen.

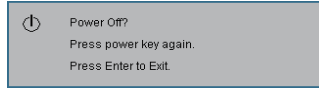

Press the “” button again to confirm the shut down. If the button is not pressed, the message will disappear in 5 seconds.

2. The cooling fans continue to operate for about 10 seconds for cooling cycle. When the Power LED turns Red, the projector has entered standby mode.

If you wish to turn the projector back on, you must wait until the projector has completed the cooling cycle and has entered standby mode. Once in standby mode, simply press “” button to restart the projector.

3. Disconnect the power cord from the electrical outlet and the projector.
4. Do not turn on the projector immediately following a power off procedure.



❖ Contact the nearest service center if the projector displays these symptoms. See pages 64-65 for more information.

## Warning Indicator

- ❖ When the “LAMP” indicator lights red, the projector will automatically shut down. Please contact your nearest service center for assistance.
- ❖ When the “TEMP” indicator lights red, it indicates the projector has overheated. The projector will shut down automatically. Under normal conditions, the projector can be switched on again after it has cooled down.
- ❖ When the “TEMP” indicator flashes red, it indicates the fan has failed.

## Adjusting the Projected Image

### Adjusting the Projector's Height

*The projector is equipped with elevator feet for adjusting the image height.*

1. Locate the adjustable foot you wish to modify on the underside of the projector.
2. Rotate the adjustable ring counter clockwise to raise the projector or clockwise to lower it. Repeat with the remaining feet as needed.

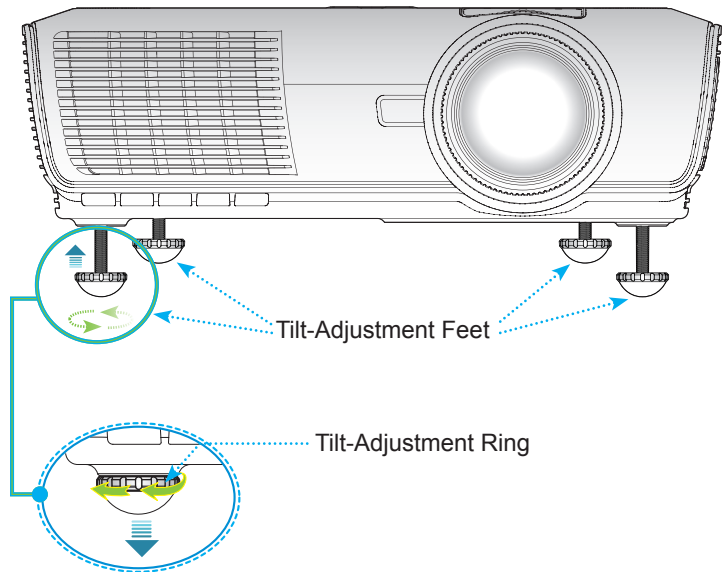

# Installation

## Adjusting the Projector's Zoom / Focus

You may turn the zoom to zoom in or out. To focus the image, rotate the focus ring until the image is clear. The projector will focus at distances from 3.28 to 32.81 feet (1.0 to 10.0 meters).

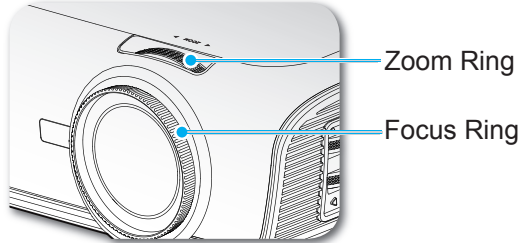

## Adjusting Projection Image Size

### ► WXGA model

Diagonal length (inch) size of 16:10 Screen	Screen Size W × H (16:10)				Projection distance (D)				Offset (Hd)	
	(m)		(feet)		(m)		(feet)		(m)	(feet)
	Width	Height	Width	Height	Wide	Tele	Wide	Tele		
30	0.65	0.40	2.12	1.32	0.97	1.47	3.17	4.83	0.10	0.33
40	0.86	0.54	2.83	2.77	1.29	1.96	4.22	6.44	0.13	0.44
50	1.08	0.67	3.53	2.21	1.61	2.54	5.28	8.05	0.17	0.55
60	1.29	0.81	4.24	2.65	1.93	2.95	6.33	9.66	0.20	0.66
70	1.51	1.94	4.95	3.09	2.25	3.44	7.39	11.27	0.24	0.77
80	1.72	1.08	5.65	3.53	2.57	3.93	8.45	12.88	0.27	0.88
90	1.94	1.21	6.36	3.97	2.90	4.42	9.50	14.49	0.30	0.99
100	2.15	1.35	7.07	4.42	3.22	4.91	10.56	16.10	0.34	1.10
110	2.37	1.48	7.77	4.86	3.54	5.40	11.61	17.72	0.37	1.21
130	2.80	1.75	9.19	5.74	4.18	6.38	13.72	20.94	0.44	1.44
150	3.23	2.02	10.60	6.62	4.83	7.36	15.84	24.16	0.50	1.66
180	3.88	2.42	12.72	7.95	5.79	8.84	19.00	28.99	0.61	1.99
200	4.31	2.69	14.13	8.83	6.44	9.82	21.12	32.21	0.67	2.21
250	5.38	3.37	17.67	11.04	8.04	12.27	26.39	40.26	0.84	2.76
300	6.46	4.04	20.20	13.25	9.65	-	31.67	-	1.01	3.31

### ► XGA model

Diagonal length (inch) size of 4:3 Screen	Screen Size W × H (4:3)				Projection distance (D)				Offset (Hd)	
	(m)		(feet)		(m)		(feet)		(m)	(feet)
	Width	Height	Width	Height	Wide	Tele	Wide	Tele		
30	0.65	0.4	2.13	1.31	1.0	1.6	3.28	5.25	0.12	0.39
40	0.86	0.54	2.82	1.77	1.3	2.1	4.27	6.89	0.16	0.53
50	1.08	0.67	3.54	2.20	1.6	2.7	5.25	8.86	0.20	0.66
60	1.29	0.81	4.23	2.66	2.0	3.2	6.56	10.50	0.24	0.80
70	1.51	0.94	4.95	3.08	2.3	3.8	7.55	12.47	0.28	0.93
80	1.72	1.08	5.64	3.54	2.6	4.3	8.53	14.11	0.32	1.06
90	1.94	1.21	6.36	3.97	3.0	4.8	9.84	15.75	0.36	1.19
100	2.15	1.35	7.05	4.43	3.3	5.4	10.83	17.72	0.41	1.33
120	2.58	1.62	8.46	5.31	4.0	6.4	13.12	21.00	0.49	1.59
150	3.23	2.02	10.60	6.63	4.9	8.0	16.08	26.25	0.61	1.99
180	3.88	2.42	12.73	7.94	5.9	9.7	19.36	31.82	0.73	2.38
200	4.31	2.69	14.14	8.83	6.6	10.7	21.65	35.10	0.81	2.65
250	5.38	3.37	17.65	11.06	8.2	13.4	26.90	43.96	1.01	3.32
300	6.46	4.04	21.19	13.25	9.9	-	32.48	-	1.21	3.98

❖ This table is for user's reference only.

# Installation

## Adjusting Projected Image Position Using PureShift

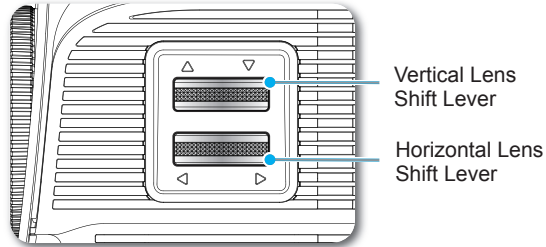

The PureShift feature provides a lens shift function that can be used to adjust the position of the projected image either horizontally or vertically within the range detailed below. PureShift is a unique system that provides lens shift while maintaining a much higher ANSI contrast ratio than traditional lens shift systems.



- ❖ The range of Vertical and Horizontal adjustment is limited as shown in the PureShift Range diagram.

### Adjusting the image position

The image can be set up to a maximum of 30% of its width either left or right of center, providing a 60% adjustment range. The vertical offset can be set between 105% - 130% of the screen height, providing 25% adjustment Range.

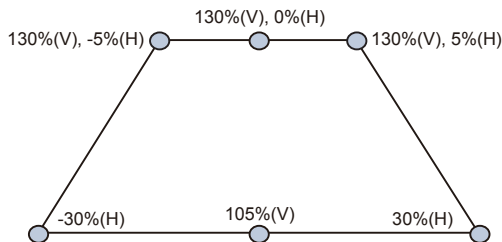

# Installation

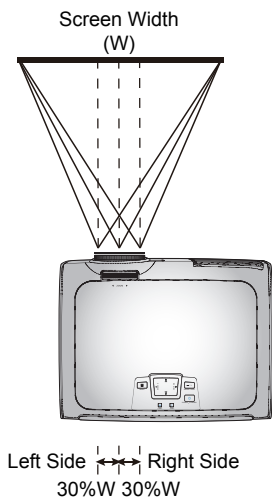
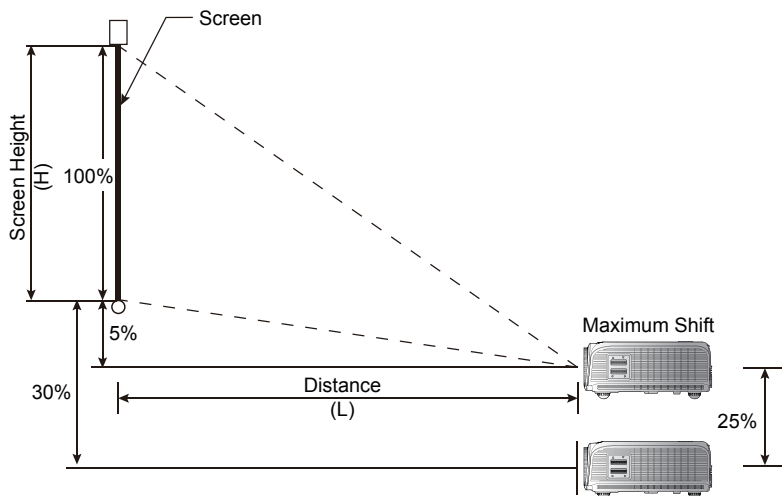



# User Controls







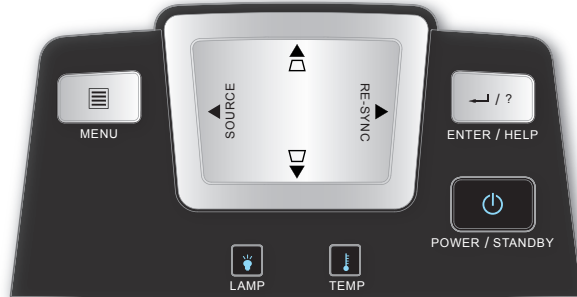



## Control Panel & Remote Control

There are two ways for you to control the functions:  
Control Panel and Remote Control.

### Control Panel



#### Using the Control Panel

 POWER / STANDBY Power LED	Refer to the “Power On/Off the Projector” section on pages 15-16. Indicate the projector’s status.
 ENTER / HELP	Confirm your item selection. Help Menu (refer to page 24).
 MENU	Press “MENU” to launch the on-screen display (OSD) menu. To exit OSD, Press “MENU” again.
RE-SYNC	Automatically synchronize the projector to the input source.
SOURCE	Press “SOURCE” to select an input signal.
Four Directional Select Keys	Use     to select items or make adjustments to your selection.
Keystone	Use   to adjust image distortion caused by tilting the projector. ( $\pm 16$ degrees)
 Lamp LED	Indicate the projector’s lamp status.
 Temp LED	Indicate the projector’s temperature status.

# User Controls

## Remote Control



### Using the Remote Control

POWER 

Refer to the “Power On/Off the Projector” section on pages 15-16.

LASER 

Aim the remote at the viewing screen, press and hold this button to activate the laser pointer.

PC/Mouse control

The PC/Mouse control can be used to control mouse movement. The mouse function is enabled using the USB cable to connect your computer and the projector.

L Button

Mouse left click.

R Button

Mouse right click.

PAGE +

Use this button to page up.

PAGE -

Use this button to page down.



Enter/Help

Confirm your item selection./ Help Menu (refer to page 24).





SOURCE

Press “SOURCE” to select an input signal.

RE-SYNC

Automatically synchronizes the projector to the input source.

Four Directional Select Keys

Use     to select items or make adjustments to your selection.

KEystone +/-

Adjust image distortion caused by tilting the projector.

VOLUME +/-

Adjust to increase / decrease the volume.

BRIGHTNESS

Adjust the brightness of the image.

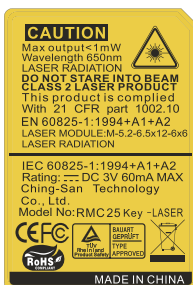

# User Controls

## Remote Control



### Using the Remote Control

MENU	Press "MENU" to launch the on-screen display (OSD) menu. To exit OSD, press "MENU" again.
ZOOM	Zoom in on an image. Press ◀▶ buttons to alter zoom. (This button has a different function on the wireless model.)
DVI-D	Press "DVI-D" to choose DVI-D source.
VGA-1	Press "VGA-1" to choose source from VGA1-IN/SCART connector.
AV MUTE	Momentarily turns off/on the audio and video.
S-VIDEO	Press "S-VIDEO" to choose S-Video source.
VGA-2	Press "VGA-2" to choose source from VGA2-In connector.
VIDEO	Press "VIDEO" to choose Composite video source.
Wireless (Ⓜ)	Press (Ⓜ) to choose wireless source. (This button has a different function on the non-wireless model.)



# User Controls

## Using the USB Remote Mouse Control

The remote control can be used as remote mouse control by connecting the projector to the computer via USB cable.

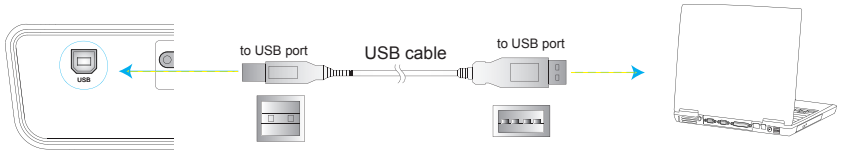

## Using the ENTER / HELP button

Press the “← / ?” button on the control panel or on the remote control to open the Help Menu.

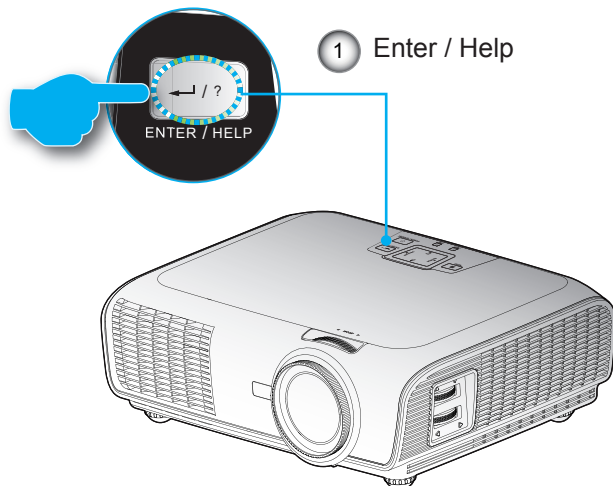

# User Controls

- ▶ If no input source is detected and help button is pressed:

The screenshots show a sequence of help pages for the error 'No Image appears on-screen.' The first page shows the error and navigation options. The second page lists general troubleshooting steps: ensuring cables are connected, pins are not bent, and AV MUTE is off. The third page provides specific instructions for notebooks, including a table of function key combinations for various brands and a path for Mac users.

HELP

? No Image appears on-screen.

UpDown Select Menu Exit

No Image appears on-screen.

- ▶ Ensure all the cables and power connections are correctly and securely connected as described in the Installation section of User's Manual.
- ▶ Ensure all the pins of connectors are not bent or broken.
- ▶ Ensure that the [AV MUTE] feature is not turned on.

[NEXT]

Exit

UpDown Select Menu Exit

No Image appears on-screen.

- ▶ If you are using a Notebook :
- 1. First, follow the steps above to adjust resolution of the computer.
- 2. Press the toggle output settings. Example : [Fn]+[F4]

Acer ⇨	[Fn]+[F5]	IBM/Lenovo ⇨	[Fn]+[F7]
Asus ⇨	[Fn]+[F8]	HP/Compaq ⇨	[Fn]+[F4]
Dell ⇨	[Fn]+[F8]	NEC ⇨	[Fn]+[F3]
Gateway ⇨	[Fn]+[F4]	Toshiba ⇨	[Fn]+[F5]

Mac Apple :

System Preference ⇨ Display ⇨ Arrangement ⇨ Mirror display

[PREV]

Exit

UpDown Select Menu Exit

- ▶ If input source is detected and help button is pressed, the following pages will appear to help diagnose any problems.

The screenshot shows a help page with four error messages and navigation options.

HELP

- ? Image has slanted sides.
- ? Image is too small or too large.
- ? Image is unstable or flickering.
- ? There is no audio heard or the volume is too low.

UpDown Select Menu Exit

# User Controls

Image has slanted sides.

- ▶ If possible, reposition the projector so that is centered on the screen and below the bottom of the screen.
- ▶ Press [KEYSTONE + / -] button until the sides are vertical on the remote control.

[KEYSTONE + / -]

 [Exit]

 UpDown    Select    Menu Exit

Image is too small or too large.



- ▶ Adjust the Zoom Ring on the top of projector.
- ▶ Move the projector closer to or further from the screen.
- ▶ Press [MENU] button on the remote control or projector panel, go to "DISPLAY | Format" and try the different settings.

[DISPLAY | Format]

 [Exit]

 UpDown    Select    Menu Exit

There is no audio heard or the volume is too low.

-  Is the volume setting at the minimum?
  - ▶ Turn up the volume setting.
-  Is the cable connected properly to the projector?
  - ▶ Check the physical connection and ensure the cable is connected properly from the source to projector.

[Volume]

 [Exit]







 UpDown    Select    Menu Exit

Image is unstable or flickering.

- ▶ Use [Phase / Frequency] to correct it.
- ▶ Change the monitor color setting on your computer.

[Phase]  
[Frequency]

 [Exit]

 UpDown    Select    Menu Exit

## On-screen Display Menus

The Projector has multilingual On-screen Display menus that allow you to make image adjustments and change a variety of settings. The projector will automatically detect the source.

### How to operate

1. To open the OSD menu, press “MENU” on the Remote Control or Projector Keypad.
2. When OSD is displayed, use ◀▶ keys to select any item in the main menu. While making a selection on a particular page, press ▼ or “Enter” key to enter sub menu.
3. Use ▲▼ keys to select the desired item and adjust the settings using ◀▶ keys.
4. Select the next item to be adjusted in the sub menu and adjust as described above.
5. Press “Enter” to confirm, and the screen will return to the main menu.
6. To exit, press “MENU” again. The OSD menu will close and the projector will automatically save the new settings.

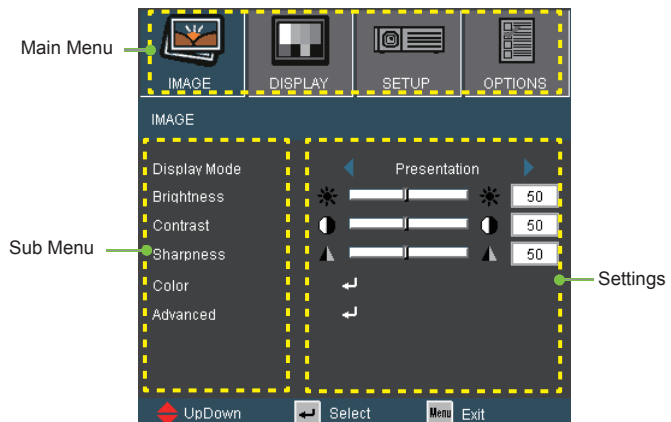

# User Controls

## Menu Tree

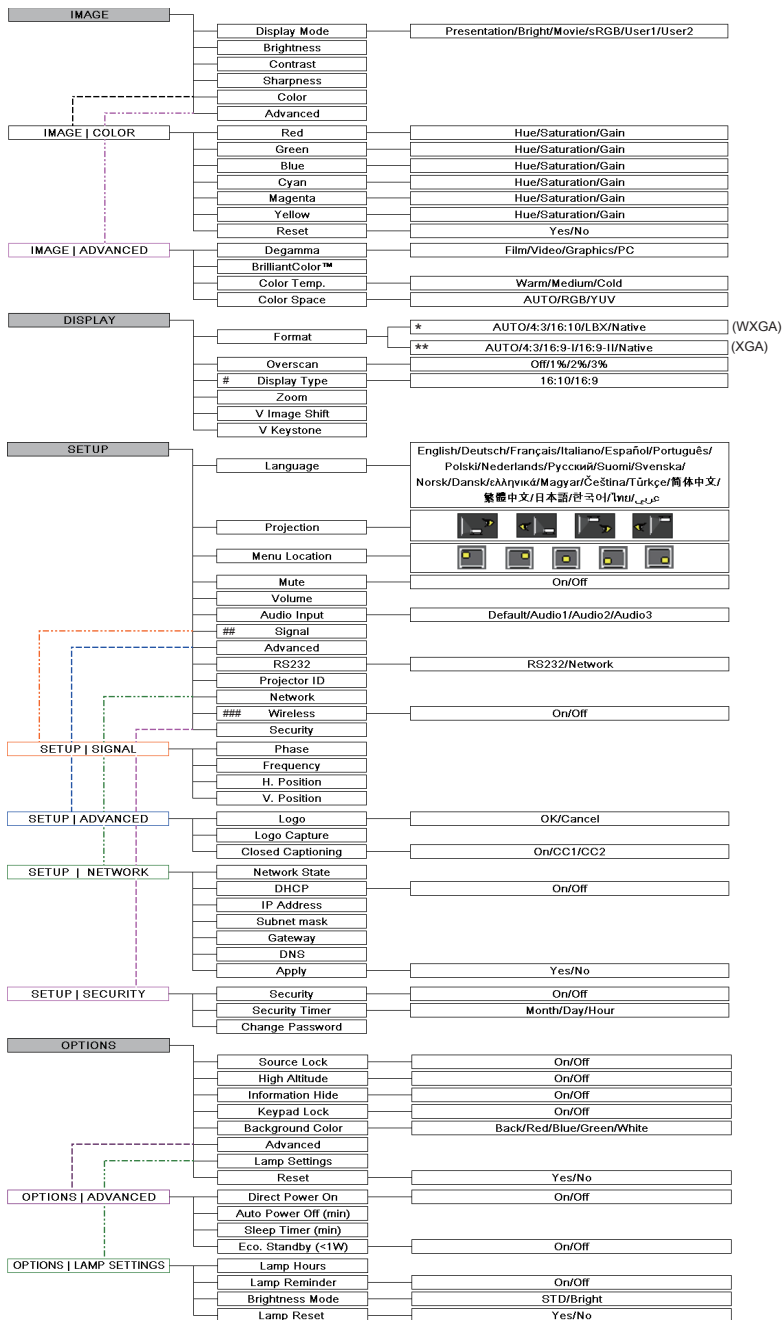



## IMAGE

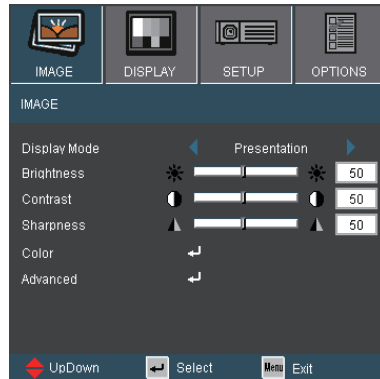

### Display Mode

There are many factory presets optimized for various types of images.

- ▶ Presentation: Good color and brightness from PC input.
- ▶ Bright: Maximum brightness from PC input.
- ▶ Movie: For home theater.
- ▶ sRGB: Standardised accurate color.
- ▶ User1: User's settings.
- ▶ User2: The initial default settings of this mode is from Movie mode. Any further adjustments by the user in User2 will be saved in this mode for future use.

### Brightness

Adjust the brightness of the image.

- ▶ Press the ◀ to darken image.
- ▶ Press the ▶ to lighten the image.

### Contrast

The contrast controls the degree of difference between the lightest and darkest parts of the picture.

- ▶ Press the ◀ to decrease the contrast.
- ▶ Press the ▶ to increase the contrast.

### Sharpness

Adjust the sharpness of the image.

- ▶ Press the ◀ to decrease the sharpness.
- ▶ Press the ▶ to increase the sharpness.

## IMAGE | Color

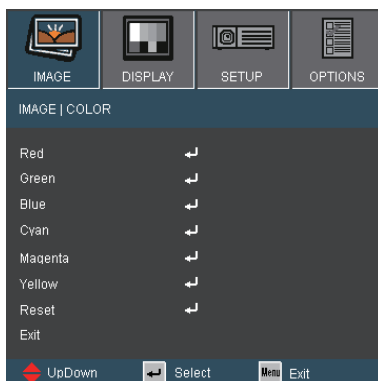

### Color

Use these settings for advanced adjustment of the individual Red, Green, Blue, Cyan, Magenta and Yellow Colors.

### Reset

Choose “Yes” to return the factory default settings for color adjustments.



### Hue

Adjust the color balance of red and green.

- ▶ Press the ◀ to increase the amount of green in the image.
- ▶ Press the ▶ to increase the amount of red in the image.

### Saturation

Adjust a video image from black and white to fully saturated color.

- ▶ Press the ◀ to decrease the amount of saturation in the image.
- ▶ Press the ▶ to increase the amount of saturation in the image.

### Gain

Use ◀ or ▶ to adjust Red, Green, Blue, Cyan, Magenta and Yellow colors for brightness (Gain).

## IMAGE | Advanced



### Degamma

This allows you to choose a degamma table that has been fine-tuned to bring out the best image quality for the input.

- ▶ Film: for home theater.
- ▶ Video: for video or TV source.
- ▶ Graphics: for image source.
- ▶ PC: for PC or computer source.

### BrilliantColor™

This adjustable item utilizes a new color-processing algorithm and system level enhancements to enable higher brightness while providing true, more vibrant colors in picture. The range is from “0” to “10”. If you prefer a stronger enhanced image, adjust toward the maximum setting. For a smoother, more natural image, adjust toward the minimum setting.

### Color Temp

If set to cold temperature, the image looks more blue. (cold image)  
If set to warm temperature, the image looks more red.  
(warm image)

### Color Space

Select an appropriate color matrix type from AUTO, RGB or YUV.

## DISPLAY



- ❖ “16:9” and “LBX” are only functional with WXGA model. “16:9-I” and “16:9-II” are only functional with XGA model.



- ❖ WXGA model: Two Display Types are supported 16:9 & 16:10.

At 16:9, available formats are Auto, 4:3, 16:9, LBX & Native.

At 16:10, available formats are Auto, 4:3, 16:10, Letter Box & Native.

(See page 36)

### Format

Use this function to choose your desired aspect ratio.

- ▶ Auto: Automatically selects the appropriate display format.
- ▶ 4:3: This format is for 4×3 input sources.
- ▶ 16:9: This format is for 16×9 input sources.
- ▶ 16:10: This format is for 16×10 input sources.
- ▶ 16:9-I: This format is for 16×9 input sources, like HDTV and DVD enhanced for Wide screen TV. (576i/p)
- ▶ 16:9-II: This format is for 16×9 input sources, like HDTV and DVD enhanced for Wide screen TV. (480i/p)
- ▶ Letter Box: This format is for non-16×9, letterbox source and for users who use external 16×9 lens to display 2.35:1 aspect ratio using full resolution.
- ▶ Native: This format displays the original image without any scaling.

# User Controls

Detail information about LBX mode :

- 1) Some Letter-Box DVDs are not enhanced for 16x9 TVs. In this situation, the image will not look right when displayed in 16:9 mode.

In this situation, please try to using the 4:3 mode to view the DVD.

If the content is not 4:3, there will be black bars around the image in 16:9 display. For this type of content, you can use LBX mode to fill the image on the 16:9 display.

- 2) If you use an external anamorphic lens, this LBX mode allows you to watch 2.35:1 content without black bars at the top and bottom of the screen. By doing so, lamp power & resolution are fully utilized.

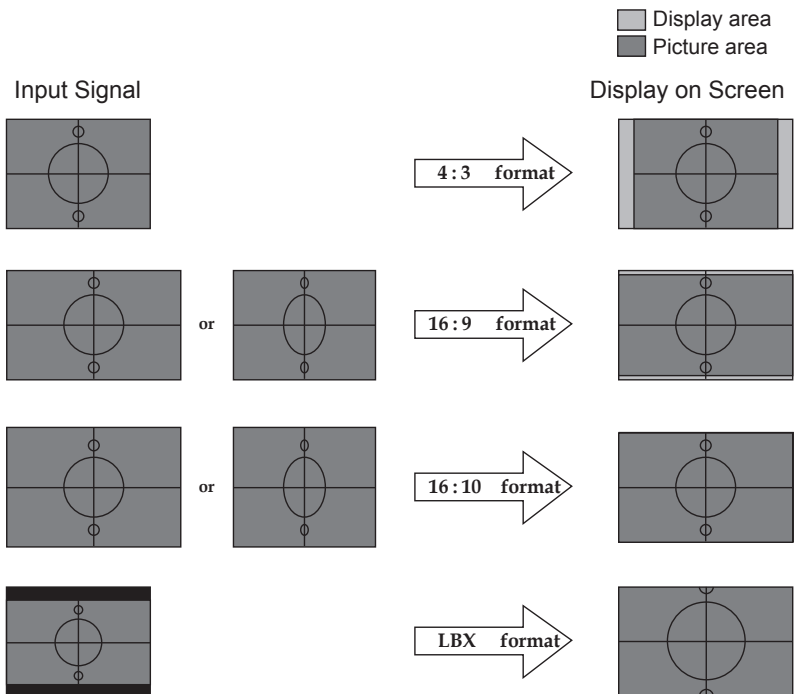

# User Controls

## ❖ WXGA model:

If this format is select, display type will auto become 16:10 (1280×800)

### ▶ Display Type: 16×10 (Re-size to 1280 × 800 center)

Format	Auto	4:3	16:10	LBX	Native
Source	480i/p	576i/p	720p	1080i/p	PC
4:3	Re-size to 1066 × 800 center				
16:10	Re-size to 1280 × 800 center				
LBX	Re-size to 1280 × 800 center				
Native	1:1 mapping center				

### ▶ Display Type: 16×9 (1280 × 720)

Format	Auto	4:3	16:9	LBX	Native
Source	480i/p	576i/p	720p	1080i/p	PC
4:3	Re-size to 960 × 720 center				
16:9	Re-size to 1280 × 720 center				
LBX	Re-size to 1280 × 720 center				
Native	1:1 mapping center				

## ❖ XGA model: (1024 × 768)

Format	Auto	4:3	16:9-I	16:9-II	Native
Source	480i/p	576i/p	720p	1080i	PC
4:3	Re-size to 1024 × 768 center				
16:9-I	Re-size to 1024 × 576 center				
16:9-II	Re-size to 854 × 480 center				
Native	1:1 mapping center				

## DISPLAY

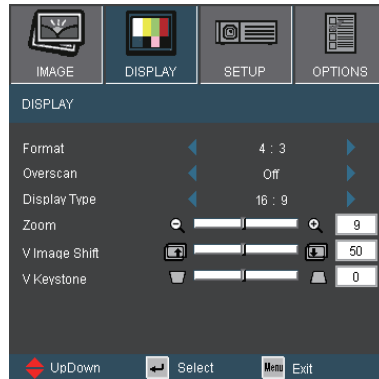

### Overscan

Overscan the image to remove video encoding noise on the edge of video source.

### Zoom

- ▶ Press the ◀ to reduce the size of an image.
- ▶ Press the ▶ to magnify an image on the projection screen.

### V Image Shift

Shift the projected image position vertically.

### V Keystone

Press the ◀ or ▶ to adjust image distortion vertically. If the image looks trapezoidal, this option can help make the image rectangular.

## DISPLAY



- ❖ “Display Type” is only functional with WXGA model.



- ❖ When “Display Type” is set to 16:9 the default format will become “4:3, 16:9, LBX, Native, AUTO” replacing original format “4:3, 16:10, LBX, Native, AUTO”.

(See page 32)

### Display Type

Choose the Display type as 16:10 (1280 x 800) or 16:9 (1280 x 720).

#### ▶ 16:10 screen

Source	480i/p	576i/p	720p	1080i/p	PC
Auto	If this format is select, screen type will auto become 16:10 (1280 × 800).				
4:3	Scale to 1066 × 800				
16:10	Scale to 1280 × 800				
LBX	Scale to 1280 × 960, then get the central 1280 × 800 image to display.				
Native	1:1 mapping centered		1280 × 720 centered	1:1 mapping centered display 1280 × 800	1:1 mapping centered

#### ▶ 16:9 screen

Source	480i/p	576i/p	720p	1080i/p	PC
Auto	If this format is select, screen type will auto become 16:10 (1280 × 800).				
4:3	Scale to 960 × 720				
16:9	Scale to 1280 × 720				
LBX	Scale to 1280 × 960, then get the central 1280 × 720 image to display.				
Native	1:1 mapping centered		1280 × 720 centered	1:1 mapping centered display 1280 × 720	1:1 mapping centered



## SETUP | Language



### Language





Choose the multilingual OSD menu. Press ◀ or ▶ into the sub menu and then use the ▲ or ▼ key to select your preferred language. Press “Enter” to finalize the selection.

## SETUP



- ❖ Rear-Desktop and Rear-Ceiling are to be used with a translucent screen.

### Projection

- ▶  **Front-Desktop**  
This is the default selection. The image is projected straight on the screen.
- ▶  **Rear-Desktop**  
When selected, the image will appear reversed.
- ▶  **Front-Ceiling**  
When selected, the image will turn upside down.
- ▶  **Rear-Ceiling**  
When selected, the image will appear reversed in upside down position.

## SETUP

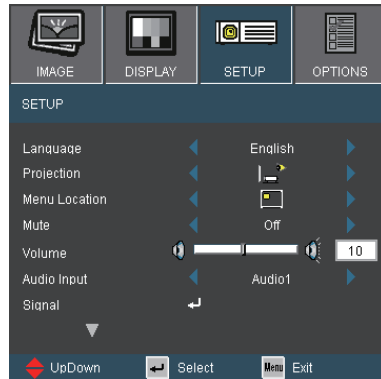

### Menu Location

Choose the menu location on the display screen.

### Mute

- ▶ Choose the “On” to turn mute on.
- ▶ Choose the “Off” to turn mute off.

### Volume

- ▶ Press the ◀ to decrease the volume.
- ▶ Press the ▶ to increase the volume.

### Audio Input

The default audio settings are on the back panel of the projector. Use this option to reassign any of the Audio Inputs (1, 2 or 3) to the current image source. Each Audio input can be assigned to more than one video source.

- ▶ AUDIO1: VGA1, S-VIDEO
- ▶ AUDIO2: VGA2, HDMI
- ▶ AUDIO3: DVI, VIDEO

## SETUP | Signal



- ❖ “Signal” is only supported in Analog VGA (RGB) signal.

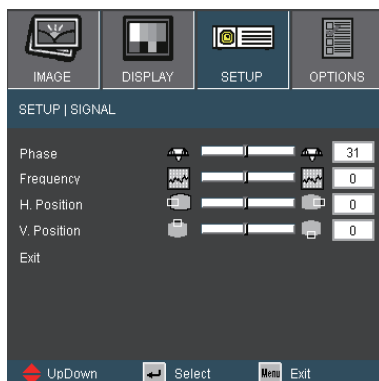

### Phase

Synchronize the signal timing of the display with the graphic card. If the image appears to be unstable or flickers, use this function to correct it.

### Frequency

Change the display data frequency to match the frequency of your computer's graphic card. Use this function only if the image appears to flicker vertically.

### H. Position

- ▶ Press the ◀ to move the image left.
- ▶ Press the ▶ to move the image right.

### V. Position

- ▶ Press the ◀ to move the image down.
- ▶ Press the ▶ to move the image up.

## SETUP | Advanced

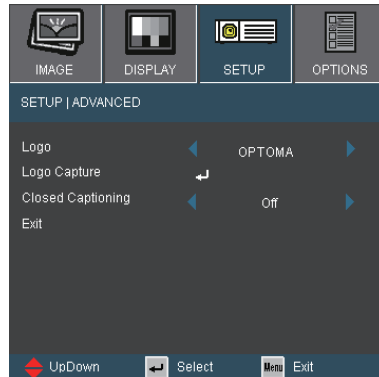

### Logo

Use this function to set the desired startup screen. If changes are made they will take effect the next time the projector is powered on.

- ▶ Optoma: The default startup screen.
- ▶ User: Uses the saved picture from the “Logo Capture” function.

### Logo Capture

Press “←” to immediately capture an image of the picture currently displayed on screen.

### Closed Captioning

- ▶ Off: select “off” to turn off the captioning feature.
- ▶ CC1: CC1 language: American English.
- ▶ CC2: CC2 language (depending on the TV channel of the user): Spanish, French, Portuguese, German, Danish.

## SETUP



### RS232

- ▶ RS232: Allow RS232 control of an individual projector.
- ▶ Network: Allow network LAN via web browser (Internet Explorer) to control projector.

### Projector ID

ID definition can be set up by menu (range 0~99), and allow user control an individual projector by RS232. Refer to page 61 for the complete list of RS232 commands.



- ❖ “Wireless” is only functional with wireless model.

### Wireless

Choose “On” to turn on the wireless mode.

## SETUP | Network

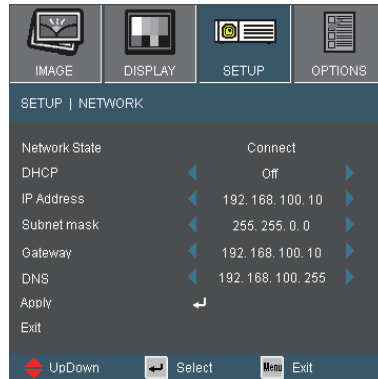

### Network State

Displays network information.

### DHCP

- ▶ On: Assign an IP address to the projector from an external DHCP server automatically.
- ▶ Off: Assign an IP address manually.

### IP Address

Select an IP address.

### Subnet Mask

Select subnet mask number.

### Gateway

Select the default gateway of the network connected to the projector.

### DNS

Select DNS number.

### Apply

Press "↵" and then choose "Yes" to apply the selection.

# User Controls

## How to use web browser to control your projector



(\*) It is **HIGHLY** recommended to contact a network administrator before installing the projector on your network.

(\*\*) There is no need to connect the computer to the router, hub or switch if it is already configured to work on the network wirelessly.

(\*\*\*) The ip address, subnet mask, gateway & dns values used are examples. The IP subnet will have to be within the range of your network.

To control the projector via web browser, the projector must have an IP address and must be connected to local network.(\*)

### ▶ DHCP ON:

- 1) If you have an existing DHCP server on your network, connect the projector to your router, hub or a switch with a straight through cable via RJ45 connection.(\*\*)
- 2) Bring up the MENU of the projector and go to **SETUP | NETWORK** to see the assigned IP address. Below is an example as to how the OSD will look.

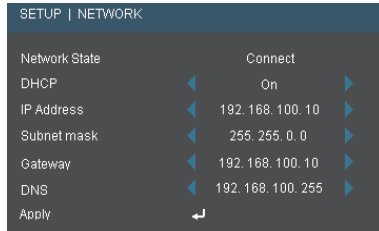

It is assumed that your computer is connected and already preconfigured to work on your network. Go to page 45 to see **Accessing Projector with web browser.**

### 3) Push "MENU" to close the OSD

### ▶ DHCP OFF:

- 1) Connect the projector and your computer to a hub or a switch with a straight through cable via RJ45 connection.
- 2) Push MENU button and go to **SETUP | NETWORK** to assign an IP address, Subnet Mask, Gateway and DNS in the dialogue box.

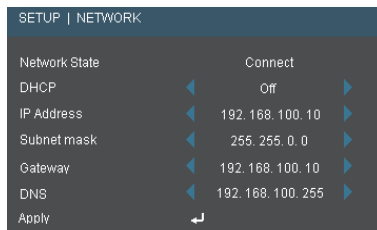

- 3) Select Apply and press "Enter" button to apply the changes and push MENU to close the OSD.(\*\*\*)



# User Controls

## Accessing Projector with web browser

(eg. Microsoft™ Internet Explorer)

- 1) Make sure your PC connects to the Wireless Projector successfully.
- 2) Open your browser, it will load the Wireless Projector home page automatically.
- 3) If not, enter the projector's IP address in the browser. This can be found on the projector's wireless start-up screen or in the OSD. (The default IP is 192.168.100.10)

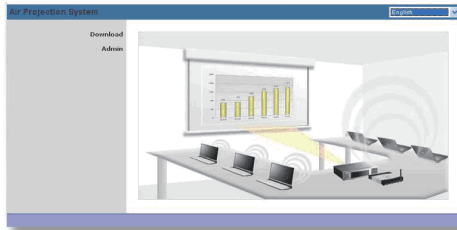

- 4) Click [Admin] and then enter password.  
NB. The password default value is "admin".
- 5) Click on [Projector control Panel] to access the projector controls.

## Advanced Wireless Features

For instructions on how to use these features, please refer to the "Wireless / Networking User manual" (On User Manual CD).



(\*) It is advised to write down the values currently set on your computer before making any changes.

## If you have a problems accessing projector controls via the Network connection.

- 1) Follow steps 1 ~ 3 for DHCP OFF as shown on Page 44.(\*)
- 2) On your computer, click Start, click Control Panel, click Network and Internet Connections, click Network Connections, click the network connection you want to configure (this would be your network card), click Properties, click Internet Protocol and click on Properties.

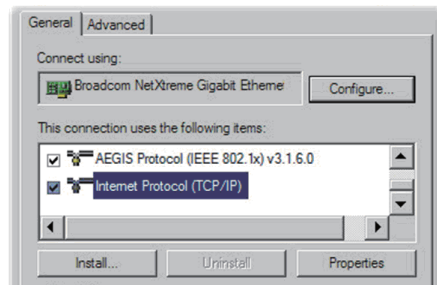

# User Controls

- 3) Select Use the following IP address and type in as below:

General

You can get IP settings assigned automatically if your network supports this capability. Otherwise, you need to ask your network administrator for the appropriate IP settings.

Obtain an IP address automatically

Use the following IP address:

IP address: 192 . 168 . 100 . 10

Subnet mask: 255 . 255 . 0 . 0

Default gateway: 192 . 168 . 100 . 10

Click on Ok and click on Ok again. Close all open windows.

- 4) On your computer, click Start, click Control Panel, click Network and Internet Connections, click Internet Options, click Connections, click LAN Settings and make sure that all fields are unchecked.

Automatic configuration

Automatic configuration may override manual settings. To ensure the use of manual settings, disable automatic configuration.

Automatically detect settings

Use automatic configuration script

Address: http://192.168.1.4/proxy.pac

Proxy server

Use a proxy server for your LAN (These settings will not apply to dial-up or VPN connections).

Address: 192.168.1.4 Port: 3128 Advanced...

Bypass proxy server for local addresses

OK Cancel

Click on OK and click on OK again. Close all open windows.

- 5) Open your Internet Explorer and type in the projector ip address as 192.168.100.10 and press enter key. You should now be able to access the projector web interface.

## SETUP | Security

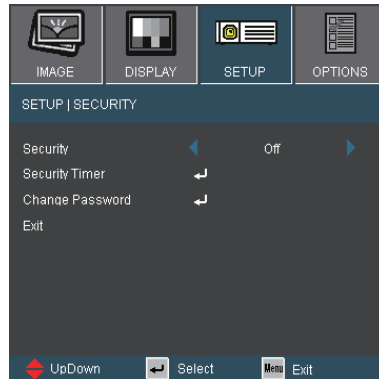

### Security

- ▶ On: Choose “On” to enable security verification when turning on the projector.
- ▶ Off: Choose “Off” to be able to switch on the projector without password verification.

### Security Timer

This function is used to select the number of hours the projector can be used (Month/Day/Hour). When you have reached the limit, you will be asked to enter the password again.



## SETUP | Security



❖ Pass-code default value is “1234” (first time).

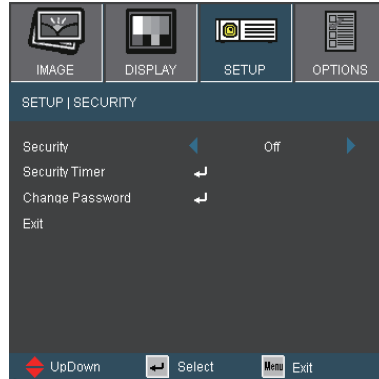

### Change Password

- ▶ First time:
  1. Press “←” to set the password.
  2. The password has to be 4 digits.
  3. Use number button on the remote to enter your new password and then press “←” key to confirm your password.
- ▶ Change Password:
  1. Press “←” to input old password.
  2. Use number button to enter current password and then press “←” to confirm.
  3. Enter new password (4 digits in length) using the number buttons on the remote, then press “←” to confirm.
  4. Enter new password again and press “←” to confirm.
- ▶ If the incorrect password is entered 3 times, the projector will automatically shut down.
- ▶ If you have forgotten your password, please contact your local office for support.

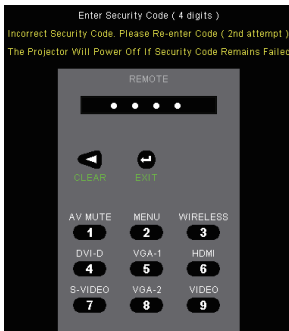

## OPTIONS

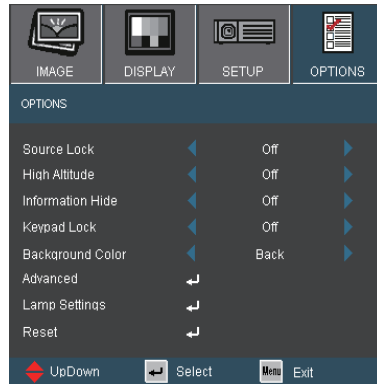

### Source Lock

- ▶ On: The projector will only search current input connection.
- ▶ Off: The projector will search for other signals if the current input signal is lost.

### High Altitude

When “On” is selected, the fans will spin faster. This feature is useful in high altitude areas where the air is thin.

### Information Hide

- ▶ On: Choose “On” to hide the info messages.
- ▶ Off: Choose “Off” to show the info messages.

### Keypad Lock

When the keypad lock function is “On”, the control panel will be locked however, the projector can be operated by the remote control. By selecting “Off”, you will be able to reuse the control panel.

### Background Color

Use this feature to display a “Black”, “Red”, “Blue”, “Green” or “White”, screen when no signal is available.

### Reset

Choose “Yes” to return the display parameters on all menus to the factory default settings.



- ❖ To turn off the keypad lock, press and hold “Enter” key on top of the projector for 5 seconds.

## OPTIONS | Advanced

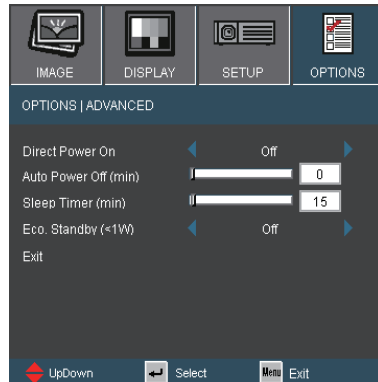

### Direct Power On

Choose “On” to activate Direct Power mode. The projector will automatically power on when AC power is supplied, without pressing the “POWER/STANDBY” key on the projector control panel or “POWER” key on the remote control.

### Auto Power Off (min)

Sets the countdown timer interval. The countdown timer will start, when there is no signal being sent to the projector. The projector will automatically power off when the countdown has finished (in minutes).

### Sleep Timer (min)

Sets the countdown timer interval. The countdown timer will start, with or without a signal being sent to the projector. The projector will automatically power off when the countdown has finished (in minutes).



❖ This disables VGA out and RJ45 control when the projector is in standby mode (<1W).

### Eco. Standby (<1W)

- ▶ On: Choose “On” to save power dissipation further < 1W.
- ▶ Off: Choose “Off” to return to normal standby mode and the VGA out port will be enabled.

## OPTIONS | Lamp Settings

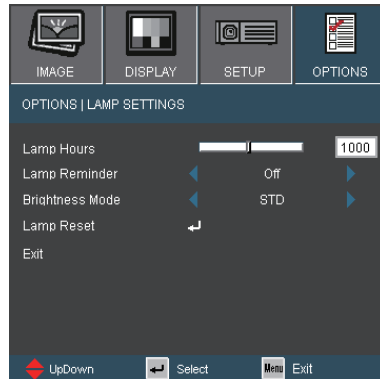

### Lamp Hours

Displays total lamp hours.

### Lamp Reminder

When turned on, a message will appear 30 hours before the end of suggested replacement lamp hour.

### Brightness Mode

- ▶ STD: Choose “STD” to dim the projector lamp which will lower power consumption and extend the lamp life by up to 130%.
- ▶ Bright: Choose “Bright” to increase the brightness.

### Lamp Reset

Reset the lamp hour counter after replacing the lamp.

## Troubleshooting

*If you experience a problem with your projector, please refer to the following information. If a problem persists, please contact your local reseller or service center.*

### Image Problems

#### **?** No image appears on-screen

- ▶ Ensure all the cables and power connections are correctly and securely connected as described in the “Installation” section.
- ▶ Ensure all the pins of connectors are not bent or broken.
- ▶ Check if the projection lamp has been securely installed. Please refer to the “Replacing the lamp” section.
- ▶ Make sure you have removed the lens cap and the projector is switched on.
- ▶ Ensure that the “AV MUTE” feature is not turned on.

#### **?** Partial, scrolling or incorrectly displayed image

- ▶ Press “RE-SYNC” on the remote.
- ▶ If you are using a PC:

##### For Windows 95, 98, 2000, XP:

1. Open the “My Computer” icon, the “Control Panel” folder, and then double click on the “Display” icon.
2. Select the “Settings” tab.
3. Verify that your display resolution setting is lower than or equal to UXGA (1600 × 1200).
4. Click on the “Advanced Properties” button.

If the projector is still not projecting the whole image, you will also need to change the monitor display you are using. Refer to the following steps.

5. Verify the resolution setting is lower than or equal to UXGA (1600 × 1200).
6. Select the “Change” button under the “Monitor” tab.



# Appendices

7. Click on “Show all devices”. Next, select “Standard monitor types” under the SP box; choose the resolution mode you need under the “Models” box.
  8. Verify that the resolution setting of the monitor display is lower than or equal to UXGA (1600 × 1200).
- ▶ If you are using a Notebook:
1. First, follow the steps above to adjust resolution of the computer.
  2. Press the appropriate keys listed below for your notebook manufacturer to send signal out from notebook to projector.  
Example: [Fn]+[F4]

Acer ⇨	[Fn]+[F5]	IBM/Lenovo ⇨	[Fn]+[F7]
Asus ⇨	[Fn]+[F8]	HP/Compaq ⇨	[Fn]+[F4]
Dell ⇨	[Fn]+[F8]	NEC ⇨	[Fn]+[F3]
Gateway ⇨	[Fn]+[F4]	Toshiba ⇨	[Fn]+[F5]

Mac Apple:

System Preference ⇨ Display ⇨ Arrangement ⇨ Mirror display

- ▶ If you experience difficulty changing resolutions or your monitor freezes, restart all equipment including the projector.

**[?]** The screen of the Notebook or PowerBook computer is not displaying your presentation

▶ If you are using a Notebook PC

Some Notebook PCs may deactivate their own screens when a second display device is in use. Each has a different way to be reactivated. Refer to your computer’s manual for detailed information.

**[?]** Image is unstable or flickering

- ▶ Use “Phase” to correct it. See page 40 for more information.  
▶ Change the monitor color setting on your computer.

**[?]** Image has vertical flickering bar

- ▶ Use “Frequency” to make an adjustment. See page 40 for more information.  
▶ Check and reconfigure the display mode of your graphic card to make it compatible with the projector.

# Appendices

## **[?]** Image is out of focus

- ▶ Make sure the lens cap is removed.
- ▶ Adjust the Focus Ring on the projector lens.
- ▶ Make sure the projection screen is between the required distance 3.28 to 32.81 feet (1.0 to 10.0 meters) from the projector.  
See page 18.



## **[?]** The image is stretched when displaying 16:9 DVD title

- ▶ When you play anamorphic DVD or 16:9 DVD, the projector will show the best image when the projector display mode is set to 16:9 in the OSD.
- ▶ If you play the LBX format DVD title, please change the format as LBX in projector OSD
- ▶ If you play 4:3 format DVD titles, please change the format to 4:3 in the projector OSD.
- ▶ If the image is still stretched, you will also need to adjust the aspect ratio by referring to the following:
- ▶ Please setup the display format as 16:9 (wide) aspect ratio type on your DVD player.

## **[?]** Image is too small or too large

- ▶ Adjust the Zoom Ring on the top of the projector.
- ▶ Move the projector closer to or further from the screen.
- ▶ Press "MENU" button on the remote control or projector panel, go to "Display → Format" and try the different settings.

## **[?]** Image has slanted sides

- ▶ If possible, reposition the projector so that it is horizontally centered on the screen and below the bottom of the screen.
- ▶ Press "KEYSTONE +/-" button on the remote control or press " / " on the projector panel, until the sides are vertical.

## **[?]** Image is reversed

- ▶ Select "SETUP → Projection" from the OSD and adjust the projection direction.



❖ Use of Keystone is not recommended.

## Other Problems

### **[?]** The projector stops responding to all controls

- ▶ If possible, turn off the projector, then unplug the power cord and wait at least 60 seconds before reconnecting power.
- ▶ Check that “Keypad Lock” is not activated by trying to control the projector with the remote control.

### **[?]** Lamp burns out or makes a popping sound

- ▶ When the lamp reaches its end of life, it will burn out and may make a loud popping sound. If this happens, the projector will not turn on until the lamp module has been replaced. To replace the lamp, follow the procedures in the “Replacing the Lamp” section on pages 57-58.

## Projector Status Indication

### **[?]** LED lighting message

Message	Power LED	Temp-LED	Lamp-LED
	(Blue/Red)	(Red)	(Red)
Standby State (Input power cord)	Red	○	○
Power on (Warming)	Flashing Blue	○	○
Lamp lighting	Blue	○	○
Power off (Cooling)	Flashing Red	○	○
Error (Over Temp.)	○	☀	○
Error (Fan fail)	○	Flashing (0.5s on, 0.5s off)	○
Error (Lamp fail)	○	○	☀

\* ON/STANDBY LED be ON when OSD appears, be OFF when OSD disappears.



Steady light ⇔ ☀

No light ⇔ ○

## **[?]** On Screen Messages

### ▶ Temperature warning:

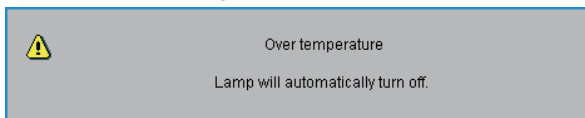

### ▶ Fan failed:

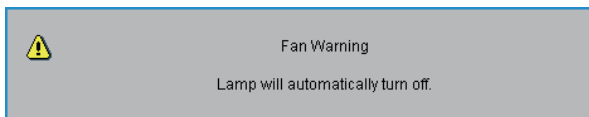

### ▶ Lamp warning:

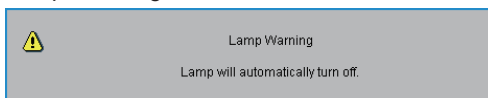

### ▶ Replacing the lamp:

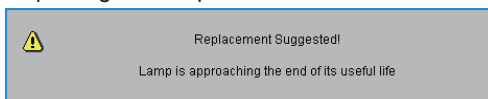

### ▶ Status Message:

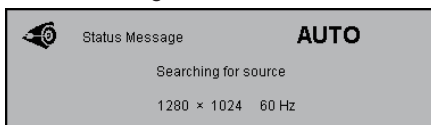

## Remote Control Problems

### **[?]** If the remote control does not work

- ▶ Check the operating angle of the remote control is within  $\pm 15^\circ$  both horizontally and vertically of one of the IR receivers on the projector.
- ▶ Make sure there are not any obstructions between the remote control and the projector. Move to within 7 m ( $\pm 0^\circ$ ) of the projector.
- ▶ Make sure the batteries are inserted correctly.
- ▶ Replace batteries if they are exhausted.

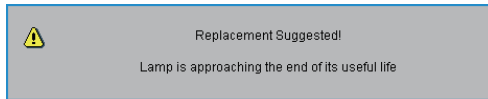

## Replacing the lamp

The projector automatically detects the lamp life. When the lamp life is nearing the end of use, you will receive a warning message.



When you see this message, please contact your local reseller or service center to change the lamp as soon as possible. Make sure the projector has been cooled down for at least 30 minutes before changing the lamp.

A yellow rectangular box containing several warning icons: a high temperature symbol, a high pressure symbol, a general warning triangle, a mercury symbol (Hg), and a crossed-out disposal symbol. Below the icons, the text reads: "CAUTION! HIGH TEMPERATURE COOL FOR 30 MINUTES. HIGH PRESSURE LAMP MAY EXPLODE IF IMPROPERLY HANDED. REFER TO LAMP REPLACEMENT INSTRUCTIONS. DISCONNECT POWER BEFORE CHANGING LAMP." Below this, it says "ATTENTION:" followed by the French translation: "A HAUTES TEMPERATURES REFROIDISSEZ PENDANT 30 MINUTES. Les lampes à haute pression peuvent exploser si elles sont mal utilisées. Confier l'entretien à une personne qualifiée. COUPER LE COURANT AVANT DE REMPLACER LES LAMPES."

-  **Warning:** If ceiling mounted, please use caution when opening the lamp access panel. It is recommended to wear safety glasses if changing the bulb when ceiling mounted. "Caution must be used to prevent any loose parts from falling out of projector."
-  **Warning:** Lamp compartment may be hot! Allow it to cool down before changing the lamp!
-  **Warning:** To reduce the risk of personal injury, do not drop the lamp module or touch the lamp bulb. The bulb may shatter and cause injury if it is dropped.

# Appendices



- ❖ The screws on the lamp cover and the lamp cannot be removed.
- ❖ The projector cannot be turned on if the lamp cover has not been placed back on the projector.
- ❖ Do not touch the glass area of the lamp. Hand oil can cause the lamp to shatter. Use a dry cloth to clean the lamp module if it was accidentally touched.

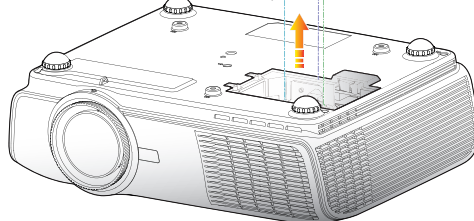
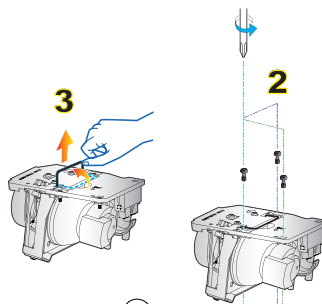
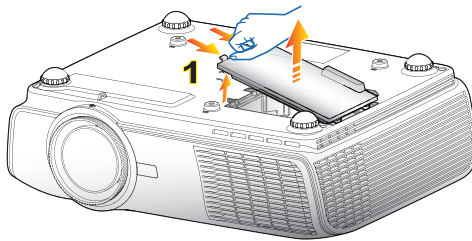

## ○ Lamp Replacement Procedure: ○

1. Switch off the power to the projector by pressing the “” button.
  2. Allow the projector to cool down for at least 30 minutes.
  3. Disconnect the power cord.
  4. Lift up and remove the cover. **1**
  5. Unscrew the three screws on the lamp module. **2**
  6. Lift up the lamp handle and remove the lamp module slowly and carefully. **3**
- To replace the lamp module, reverse the previous steps.
7. Turn on the projector and use “Lamp Reset” after the lamp module is replaced.

Lamp Reset: (i) Press “MENU” → (ii) Select “OPTIONS” → (iii) Select “Lamp Settings” → (iv) Select “Lamp Reset” → (v) Select “Yes”.

## Compatibility Modes

### ► Computer Compatibility

Mode	Resolution	V-Sync (Hz)	
		Analog	Digital
VGA	640 × 350	70, 85	70
VGA	640 × 400	85	***
VGA	640 × 480	60, 72, 75, 85	60, 72, 75
VGA	720 × 400	70, 85	70
SVGA	800 × 600	56, 60, 72, 75, 85	56, 60, 72, 75
XGA	1024 × 768	60, 70, 75, 85	60, 70, 75
SXGA	1152 × 864	70, 75, 85	70, 75, 85
SXGA	1280 × 1024	60, 75, 85	60, 75, 85
SXGA+	1400 × 1050	60	60
UXGA	1600 × 1200	60	60
MAC LC 13"	640 × 480	66.66	***
MAC II 13"	640 × 480	66.68	***
MAC 16"	832 × 624	74.55	***
MAC 19"	1024 × 768	75	***
MAC	1152 × 870	75.06	***
MAC G4	640 × 480	60	***
i MAC DV	1024 × 768	75	***
i MAC DV	1152 × 870	75	***
i MAC DV	1280 × 960	60	***
WXGA	1280 × 720	60	60, 75, 85
WXGA	1280 × 768	60	60, 75, 85
WXGA	1280 × 800	60	60, 75, 85



❖ For widescreen resolution (WXGA), the compatibility support is dependent on Notebook/PC models.

### ► Video Compatibility

NTSC	M (3.58MHz), 4.43 MHz, 480i/p @60Hz
PAL	B, D, G, H, I, M, N, 576i/p @50Hz
SECAM	B, D, G, K, K1, L
SDTV/HDTV	480i/p, 576i/p, 720p@50Hz/60Hz, 1080i/p@50Hz/60Hz

## RS232 Commands

### RS232 Pin Assignments

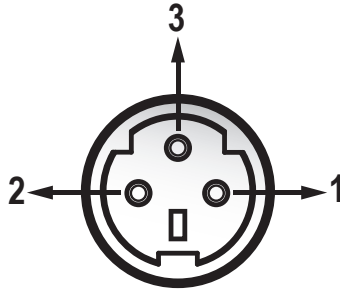

Pin no.	Name	I/O (From Projector Side)
1	TXD	OUT
2	RXD	IN
3	GND	GND

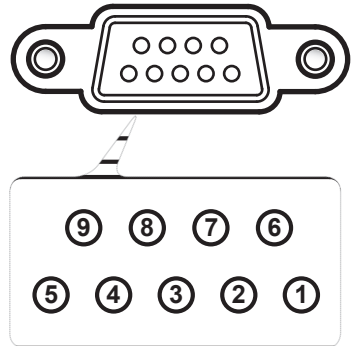

Pin no.	Spec.
1	N/A
2	RXD
3	TXD
4	N/A
5	GND
6	N/A
7	N/A
8	N/A
9	N/A



## RS232 Protocol Function List

### RS232 Commands

Baud Rate : 9600

Data Bits : 8

Parity: None

Stop Bits: 1

Flow Control : None

UART16550 FIFO: Disable

Projector Return (Pass): P

Projector Return (Fail): F

XX=00-99, projector's ID,

XX=00 is for all projectors

SEND to projector		Function	Description
232 ASCII Code	HEX Code		
--XX00 1	7E 30 30 30 30 20 31 0D	Power ON	
--XX00 0	7E 30 30 30 30 20 30 0D	Power OFF	
--XX01 1	7E 30 30 30 31 20 31 0D	Resync	
--XX02 1	7E 30 30 30 32 20 31 0D	AV Mute	On
--XX02 0	7E 30 30 30 32 20 30 0D		Off
--XX03 1	7E 30 30 30 33 20 31 0D	Mute	On
--XX03 0	7E 30 30 30 33 20 30 0D		Off
--XX04 1	7E 30 30 30 34 20 31 0D	Freeze	
--XX04 0	7E 30 30 30 34 20 30 0D	Unfreeze	
--XX05 1	7E 30 30 30 35 20 31 0D	Zoom Plus	
--XX06 1	7E 30 30 30 36 20 31 0D	Zoom Minus	
--XX07 1	7E 30 30 30 37 20 31 0D	Up (Pan under zoom)	
--XX08 2	7E 30 30 30 38 20 31 0D	Down (Pan under zoom)	
--XX09 1	7E 30 30 30 39 20 31 0D	Left (Pan under zoom)	
--XX10 1	7E 30 30 31 30 20 31 0D	Right (Pan under zoom)	
--XX11 1	7E 30 30 31 32 20 31 0D	Direct Source Commands	
--XX12 1	7E 30 30 31 32 20 32 0D		HDMI
--XX12 2	7E 30 30 31 32 20 33 0D		DVI-D
--XX12 3	7E 30 30 31 32 20 34 0D		VGA 1
--XX12 4	7E 30 30 31 32 20 35 0D		VGA 2
--XX12 5	7E 30 30 31 32 20 36 0D		VGA 1 SCART
--XX12 6	7E 30 30 31 32 20 37 0D		VGA 1 Component
--XX12 7	7E 30 30 31 32 20 38 0D		S-Video
--XX12 8	7E 30 30 31 32 20 39 0D		Video
--XX12 9	7E 30 30 31 32 20 3A 0D		Wireless
--XX12 10	7E 30 30 31 32 20 3B 0D		VGA 2 Component
--XX12 11	7E 30 30 31 32 20 3C 0D		* For EX765W / EW766W only
--XX12 13	7E 30 30 31 32 20 3D 0D		
--XX20 1	7E 30 30 32 30 20 31 0D	Display Mode	Presentation
--XX20 2	7E 30 30 32 30 20 32 0D		Bright
--XX20 3	7E 30 30 32 30 20 33 0D		Movie
--XX20 4	7E 30 30 32 30 20 34 0D		sRGB
--XX20 5	7E 30 30 32 30 20 35 0D		User1
--XX20 6	7E 30 30 32 30 20 36 0D		User2
--XX21 n	7E 30 30 32 31 20 a 0D	Brightness	n = 0 (a=30) ~ 100 (a=31 30 30)
--XX22 n	7E 30 30 32 32 20 a 0D	Contrast	n = 0 (a=30) ~ 100 (a=31 30 30)
--XX23 n	7E 30 30 32 33 20 a 0D	Sharpness	n = 0 (a=30) ~ 31 (a=33 31)
--XX170 n	7E 30 30 31 37 30 20 a 0D	Color	Red Hue n = -50 (a=2D 35 30) ~ 50 (a=35 30)
--XX171 n	7E 30 30 31 37 31 20 a 0D		Red Saturation n = 0 (a=30) ~ 100 (a=31 30 30)
--XX27 n	7E 30 30 32 37 20 a 0D		Red Gain n = 0 (a=30) ~ 100 (a=31 30 30)
--XX172 n	7E 30 30 31 37 32 20 a 0D		Green Hue n = -50 (a=2D 35 30) ~ 50 (a=35 30)
--XX173 n	7E 30 30 31 37 33 20 a 0D		Green Saturation n = 0 (a=30) ~ 100 (a=31 30 30)
--XX28 n	7E 30 30 32 38 20 a 0D		Green Gain n = 0 (a=30) ~ 100 (a=31 30 30)
--XX174 n	7E 30 30 31 37 34 20 a 0D		Blue Hue n = -50 (a=2D 35 30) ~ 50 (a=35 30)
--XX175 n	7E 30 30 31 37 35 20 a 0D		Blue Saturation n = 0 (a=30) ~ 100 (a=31 30 30)
--XX29 n	7E 30 30 32 39 20 a 0D		Blue Gain n = 0 (a=30) ~ 100 (a=31 30 30)
--XX176 n	7E 30 30 31 37 36 20 a 0D		Cyan Hue n = -50 (a=2D 35 30) ~ 50 (a=35 30)
--XX177 n	7E 30 30 31 37 37 20 a 0D		Cyan Saturation n = 0 (a=30) ~ 100 (a=31 30 30)
--XX30 n	7E 30 30 33 30 20 a 0D		Cyan Gain n = 0 (a=30) ~ 100 (a=31 30 30)
--XX178 n	7E 30 30 31 37 38 20 a 0D		Yellow Hue n = -50 (a=2D 35 30) ~ 50 (a=35 30)
--XX179 n	7E 30 30 31 37 39 20 a 0D		Yellow Saturation n = 0 (a=30) ~ 100 (a=31 30 30)
--XX31 n	7E 30 30 33 31 20 a 0D		Yellow Gain n = 0 (a=30) ~ 100 (a=31 30 30)
--XX180 n	7E 30 30 31 38 30 20 a 0D		Magenta Hue n = -50 (a=2D 35 30) ~ 50 (a=35 30)
--XX181 n	7E 30 30 31 38 31 20 a 0D		Magenta Saturation n = 0 (a=30) ~ 100 (a=31 30 30)
--XX32 n	7E 30 30 33 32 20 a 0D		Magenta Gain n = 0 (a=30) ~ 100 (a=31 30 30)
--XX33 1	7E 30 30 33 33 20 31 0D		Reset
--XX34 n	7E 30 30 33 34 20 a 0D	BrilliantColor <sup>TM</sup>	n = 0 (a=30) ~ 10 (a=31 30)
--XX35 1	7E 30 30 33 35 20 31 0D	Degamma	Film
--XX35 2	7E 30 30 33 35 20 32 0D		Video
--XX35 3	7E 30 30 33 35 20 33 0D		Graphics
--XX35 4	7E 30 30 33 35 20 34 0D		PC
--XX36 1	7E 30 30 33 36 20 31 0D	Color Temp.	Warm
--XX36 2	7E 30 30 33 36 20 32 0D		Medium
--XX36 3	7E 30 30 33 36 20 33 0D		Cold
--XX37 1	7E 30 30 33 37 20 31 0D	Color Space	Auto
--XX37 2	7E 30 30 33 37 20 32 0D		RGB
--XX37 3	7E 30 30 33 37 20 33 0D		YUV
--XX44 n	7E 30 30 34 34 20 a 0D		Saturation n = 0 (a=30) ~ 100 (a=31 30 30)
--XX45 n	7E 30 30 34 35 20 a 0D		Tint n = 0 (a=30) ~ 100 (a=31 30 30)
--XX60 1	7E 30 30 36 30 20 31 0D	Format	4:3
--XX60 2	7E 30 30 36 30 20 32 0D		16:9-1
--XX60 3	7E 30 30 36 30 20 33 0D		16:9-1/16:10 (WXGA)
--XX60 5	7E 30 30 36 30 20 35 0D		1.BkX (WXGA projector only)
--XX60 6	7E 30 30 36 30 20 36 0D		Native
--XX60 7	7E 30 30 36 30 20 37 0D		Auto
--XX61 n	7E 30 30 36 31 20 a 0D	Overscan	n = 0 (a=30) ~ 3 (a=33)
--XX62 n	7E 30 30 36 32 20 a 0D	Zoom	n = -7 (a=2D 37) ~ 25 (a=32 35)
--XX64 n	7E 30 30 36 34 20 a 0D	V Image Shift	n = 0 (a=30) ~ 100 (a=31 30 30)
--XX66 n	7E 30 30 36 36 20 a 0D	V Keystone	n = -40 (a=2D 34 30) ~ 40 (a=34 30)
--XX70 1	7E 30 30 37 30 20 31 0D	Language	English
--XX70 2	7E 30 30 37 30 20 32 0D		German
--XX70 3	7E 30 30 37 30 20 33 0D		French
--XX70 4	7E 30 30 37 30 20 34 0D		Italian
--XX70 5	7E 30 30 37 30 20 35 0D		Spanish
--XX70 6	7E 30 30 37 30 20 36 0D		Portuguese
--XX70 7	7E 30 30 37 30 20 37 0D		Polish
--XX70 8	7E 30 30 37 30 20 38 0D		Dutch
--XX70 9	7E 30 30 37 30 20 39 0D		Swedish
--XX70 10	7E 30 30 37 30 20 3A 0D		Norwegian/Danish
--XX70 11	7E 30 30 37 30 20 3B 0D		Finnish
--XX70 12	7E 30 30 37 30 20 3C 0D		Greek
--XX70 13	7E 30 30 37 30 20 3D 0D		Traditional Chinese
--XX70 14	7E 30 30 37 30 20 3E 0D		Simplified Chinese
--XX70 15	7E 30 30 37 30 20 3F 0D		Japanese
--XX70 16	7E 30 30 37 30 20 3A 0D		Korean
--XX70 17	7E 30 30 37 30 20 3B 0D		Russian
--XX70 18	7E 30 30 37 30 20 3C 0D		Hungarian
--XX70 19	7E 30 30 37 30 20 3D 0D		Czechoslovak
--XX70 20	7E 30 30 37 30 20 3E 0D		Arabic
--XX70 21	7E 30 30 37 30 20 3F 0D		Thai
--XX71 1	7E 30 30 37 31 20 31 0D	Projection	Front-Desktop
--XX71 2	7E 30 30 37 31 20 32 0D		Rear-Desktop
--XX71 3	7E 30 30 37 31 20 33 0D		Front-Ceiling
--XX71 4	7E 30 30 37 31 20 34 0D		Rear-Ceiling



1. There is a <CR> after all ASCII commands.
2. 0D is the HEX code for <CR> in ASCII code.

# Appendices

## SEND to projector

232 ASCII Code	HEX Code	Function	Projector Return	Description
-XX72 1	7E 30 37 32 20 31 0D	Menu Location	Top Left	
-XX72 2	7E 30 37 32 20 32 0D		Top Right	
-XX72 3	7E 30 37 32 20 33 0D		Centre	
-XX72 4	7E 30 37 32 20 34 0D		Bottom Left	
-XX72 5	7E 30 37 32 20 35 0D		Bottom Right	
-XX73 n	7E 30 37 33 20 a 0D	Signal	Frequency	n = -100 (a=2D 31 30 30) ~ 100 (a=31 30 30)
-XX74 n	7E 30 37 34 20 a 0D		Phase	n = 0 (a=30) ~ 63 (a=36 33)
-XX75 n	7E 30 37 35 20 a 0D		H. Position	n = -100 (a=2D 31 30 30) ~ 100 (a=31 30 30)
-XX76 n	7E 30 37 36 20 a 0D		V. Position	n = -100 (a=2D 31 30 30) ~ 100 (a=31 30 30)
-XX77 n	7E 30 37 37 20 aabcc 0D	Security	Security Timer	Month/Day/Hours n = mm/dd/hh mm = 00 (aa=30 30) ~ 99 (aa=39 39) dd = 00 (bb=30 30) ~ 29 (bb=32 39) hh = 00 (cc=30 30) ~ 23 (cc=32 33)
-XX78 1	7E 30 37 38 20 31 0D		Security Settings	Enable
-XX78 2	7E 30 37 38 20 32 0D			Disable
-XX79 n	7E 30 37 39 20 a 0D	Projector ID		n = 00 (a=30 30) ~ 99 (a=39 39)
-XX80 1	7E 30 38 30 20 31 0D	Mute	On	
-XX80 0	7E 30 38 30 20 30 0D		Off	
-XX81 n	7E 30 38 31 20 a 0D	Volume		n = 0 (a=30) ~ 20 (a=32 30)
-XX82 1	7E 30 38 32 20 31 0D	Logo	Optoma	
-XX82 2	7E 30 38 32 20 32 0D		User	
-XX83 1	7E 30 38 33 20 31 0D	Logo Capture		
-XX86 1	7E 30 38 36 20 31 0D	RS232 Port	RS232	
-XX86 2	7E 30 38 36 20 32 0D		Network	
-XX88 0	7E 30 38 38 20 30 0D	Closed Captioning	Off	
-XX88 1	7E 30 38 38 20 31 0D	Closed Captioning	CC1	
-XX88 2	7E 30 38 38 20 32 0D	Closed Captioning	CC2	
-XX89 1	7E 30 38 39 20 31 0D	Audio Input	Default	
-XX89 2	7E 30 38 39 20 32 0D		AUDIO1	
-XX89 3	7E 30 38 39 20 33 0D		AUDIO2	
-XX89 4	7E 30 38 39 20 34 0D		AUDIO3	
-XX100 1	7E 30 31 30 30 20 31 0D	Source Lock	On	
-XX100 0	7E 30 31 30 30 20 30 0D		Off	
-XX100 3	7E 30 31 30 30 20 33 0D	Next Source		
-XX101 1	7E 30 31 30 31 20 31 0D	High Altitude	On	
-XX101 0	7E 30 31 30 31 20 30 0D		Off	
-XX102 1	7E 30 31 30 32 20 31 0D	Information Hide	On	
-XX102 0	7E 30 31 30 32 20 30 0D		Off	
-XX103 1	7E 30 31 30 33 20 31 0D	Keypad Lock	On	
-XX103 0	7E 30 31 30 33 20 30 0D		Off	
-XX104 1	7E 30 31 30 34 20 31 0D	Background Color	Blue	
-XX104 2	7E 30 31 30 34 20 32 0D		Black	
-XX104 3	7E 30 31 30 34 20 33 0D		Red	
-XX104 4	7E 30 31 30 34 20 34 0D		Green	
-XX104 5	7E 30 31 30 34 20 35 0D		White	
-XX105 1	7E 30 31 30 35 20 31 0D	Advanced	Direct Power On	On
-XX105 0	7E 30 31 30 35 20 30 0D		Off	
-XX113 1	7E 30 31 31 33 20 31 0D		Signal Power On	On
-XX113 0	7E 30 31 31 33 20 30 0D		Off	
-XX106 n	7E 30 31 30 36 20 a 0D		Auto Power Off (min)	n = 0 (a=30) ~ 180 (a=31 39 39)
-XX107 n	7E 30 31 30 37 20 a 0D		Sleep Timer (min)	n = 0 (a=30) ~ 995 (a=39 39 39) , step +/-5
-XX114 1	7E 30 31 31 34 20 31 0D		Eco. Standby(1W)	On
-XX114 0	7E 30 31 31 34 20 30 0D		Off	
-XX108 1	7E 30 31 30 38 20 31 0D	Lamp Setting	Lamp Hours	On
-XX109 1	7E 30 31 30 39 20 31 0D		Lamp Reminder	On
-XX109 0	7E 30 31 30 39 20 30 0D		Off	
-XX110 1	7E 30 31 31 30 20 31 0D		Brightness Mode	Bright
-XX110 0	7E 30 31 31 30 20 30 0D			STD
-XX111 1	7E 30 31 31 31 30 31 0D		Lamp Reset	Yes
-XX111 0	7E 30 31 31 31 30 30 0D			No
-XX112 1	7E 30 31 31 32 20 31 0D	Reset		Yes
-XX112 0	7E 30 31 31 32 20 30 0D			No
-XX210 n	7E 30 32 31 30 20 a 0D		Message	n : characters (max length is 30)

## SEND to Remote

-XX140 1	7E 30 31 34 30 20 31 0D		Power	
-XX140 2	7E 30 31 34 30 20 32 0D		Re-sync	
-XX140 3	7E 30 31 34 30 20 33 0D		Keystone +	
-XX140 4	7E 30 31 34 30 20 34 0D		Keystone -	
-XX140 5	7E 30 31 34 30 20 34 0D		AV Mute	
-XX140 7	7E 30 31 34 30 20 37 0D		Zoom	* EX765 / EW766 Only
-XX140 9	7E 30 31 34 30 20 39 0D		Volume +	
-XX140 10	7E 30 31 34 30 20 31 30 0D		Volume -	
-XX140 11	7E 30 31 34 30 20 31 31 0D		Enter	
-XX140 12	7E 30 31 34 30 20 31 32 0D		Menu	
-XX140 13	7E 30 31 34 30 20 31 33 0D		Left	
-XX140 14	7E 30 31 34 30 20 31 34 0D		Up	
-XX140 15	7E 30 31 34 30 20 31 35 0D		Right	
-XX140 16	7E 30 31 34 30 20 31 36 0D		Down	
-XX140 18	7E 30 31 34 30 20 31 38 0D		1	* Security Code
-XX140 19	7E 30 31 34 30 20 31 39 0D		2	
-XX140 20	7E 30 31 34 30 20 32 0D		3	
-XX140 21	7E 30 31 34 30 20 32 31 0D		4	
-XX140 22	7E 30 31 34 30 20 32 32 0D		5	
-XX140 23	7E 30 31 34 30 20 32 33 0D		6	
-XX140 24	7E 30 31 34 30 20 32 34 0D		7	
-XX140 25	7E 30 31 34 30 20 32 35 0D		8	
-XX140 26	7E 30 31 34 30 20 32 36 0D		9	

## SEND from projector automatically

232 ASCII Code	HEX Code	Function	Projector Return	Description
		when standby/warming/cooling/out of range	IN/On	n : 0/1/2/3/4/6/7/8 = Standby/Warming/Cooling/Out of Range/ Lamp fail/Fan Lock/Over Temperature/Lamp Hours Running Out

## READ from projector

232 ASCII Code	HEX Code	Function	Projector Return	Description
-XX121 1	7E 30 31 32 31 20 31 0D	Input Source Commands	OKn	n : 0/1/2/3/4/5/6/7 = None/DVI/VGA1/VGA2/S-Video/Video/HDMI/Wireless
-XX122 1	7E 30 31 32 32 20 31 0D	Software Version	OKdd	
-XX123 1	7E 30 31 32 33 20 31 0D	Display Mode	OKn	n : 0/1/2/3/4/5 = Presentation/Bright/Movie/sRGB/User1/User2
-XX124 1	7E 30 31 32 34 20 31 0D	Power State	OKn	n : 0/1 = Off/On
-XX125 1	7E 30 31 32 35 20 31 0D	Brightness	OKn	
-XX126 1	7E 30 31 32 36 20 31 0D	Contrast	OKn	
-XX127 1	7E 30 31 32 37 20 31 0D	Aspect Ratio	OKn	n : 0/1/2/3 = 4:3/16:9/16:9/Window
-XX128 1	7E 30 31 32 38 20 31 0D	Color Temperature	OKn	n : 0/1/2 = Warm/Medium/Cold
-XX129 1	7E 30 31 32 39 20 31 0D	Projection Mode	OKn	n : 0/1/2/3 = Front/Desktop/Rear/Desktop/ Front-Ceiling/ Rear-Ceiling
-XX150 1	7E 30 31 35 30 20 31 0D	Information	OKabbbccddddd	a : 0/1 = Off/On bbbb: Lamp/hour cc: source 00/01/02/03/04/05/06/07 = None/DVI/VGA1/VGA2/S-Video/Video/HDMI/Wireless dddd: FW version e : Display mode 0/1/2/3/4/5 None/Presentation/Bright/Movie/sRGB/User1/User2 n : /1:2 = EX765/EW766
-XX151 1	7E 30 31 35 31 20 31 0D	Model name	OKn	

## Ceiling Mount Installation

1. To prevent damage to your projector, please use the Optoma ceiling mount.
2. If you wish to use a third party ceiling mount kit, please ensure the screws used to attach a mount to the projector meet the following specifications:

- ▶ Screw type: M4
- ▶ Screw length: 8mm



❖ Please note that damage resulting from incorrect installation will invalidate the warranty.



### ⚠ Warning:

1. If you buy a ceiling mount from another company, please be sure to use the correct screw size. Screw size will vary depending on the thickness of the mounting plate.
2. Be sure to keep at least 10 cm gap between the ceiling and the bottom of the projector.
3. Avoid installing the projector near a heat source.

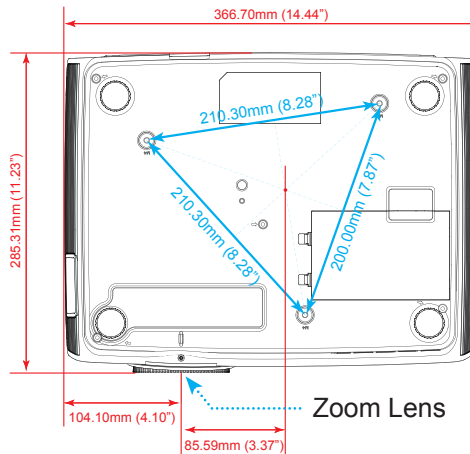

## Optoma Global Offices

*For service or support please contact your local office.*

### USA

715 Sycamore Drive  
Milpitas, CA 95035, USA  
www.optomausa.com

Tel : 408-383-3700  
Fax: 408-383-3702  
Service : [services@optoma.com](mailto:services@optoma.com)

### Canada

5630 Kennedy Road, Mississauga,  
ON, L4Z 2A9, Canada  
www.optoma.ca

Tel : 905-361-2582  
Fax: 905-361-2581  
Service : [canadacsragent@optoma.com](mailto:canadacsragent@optoma.com)

### Europe

42 Caxton Way, The Watford Business Park  
Watford, Hertfordshire,  
WD18 8QZ, UK  
www.optoma.eu  
Service Tel : +44 (0)1923 691865

Tel : +44 (0) 1923 691 800  
Fax: +44 (0) 1923 691 888  
Service : [service@tsc-europe.com](mailto:service@tsc-europe.com)

### France

Bâtiment E  
81-83 avenue Edouard Vaillant  
92100 Boulogne Billancourt, France

Tel : +33 1 41 46 12 20  
Fax: +33 1 41 46 94 35  
Service : [savoptoma@optoma.fr](mailto:savoptoma@optoma.fr)

### Spain

C/ José Hierro,36 Of. 1C  
28529 Rivas VaciaMadrid,  
Spain

Tel : +34 91 499 06 06  
Fax: +34 91 670 08 32

### Deutschland

Werftstrasse 25  
D40549 Düsseldorf,  
Germany

Tel : +49 (0) 211 506 6670  
Fax: +49 (0) 211 506 66799  
Service : [info@optoma.de](mailto:info@optoma.de)

### Scandinavia

Grev Wedels Plass 2  
3015 Drammen  
Norway

Tel : +47 32 26 89 90  
Fax: +47 32 83 78 98  
Service : [info@optoma.no](mailto:info@optoma.no)

### Latin America

715 Sycamore Drive  
Milpitas, CA 95035, USA  
www.optoma.com.br

Tel : 408-383-3700  
Fax: 408-383-3702  
www.optoma.com.mx

## Korea

WOOMI TECH.CO.,LTD.

4F,Minu Bldg,33-14, Kangnam-Ku,  
seoul,135-815, KOREA

Tel : +82+2+34430004

Fax: +82+2+34430005

## Japan

東京都足立区綾瀬3-25-18

株式会社オーエスエム

サポートセンター:0120-46-5040

E-mail : [info@osscreen.com](mailto:info@osscreen.com)

[www.os-worldwide.com](http://www.os-worldwide.com)

## Taiwan

5F., No. 108, Minchiuan Rd.

Shindian City,

Taipei Taiwan 231, R.O.C.

[www.optoma.com.tw](http://www.optoma.com.tw)

Tel : +886-2-2218-2360

Fax: +886-2-2218-2313

Service : [services@optoma.com.tw](mailto:services@optoma.com.tw)

[asia.optoma.com](http://asia.optoma.com)

## Hong Kong

Unit A, 27/F Dragon Centre,

79 Wing Hong Street,

Cheung Sha Wan,

Kowloon, Hong Kong

Tel : +852-2396-8968

Fax: +852-2370-1222

[www.optoma.com.hk](http://www.optoma.com.hk)

## China

5F, No. 1205, Kaixuan Rd.,

Changning District

Shanghai, 200052, China

Tel : +86-21-62947376

Fax: +86-21-62947375

[www.optoma.com.cn](http://www.optoma.com.cn)

## Regulation & Safety notices

*This appendix lists the general notices of your projector.*

### **FCC notice**

This device has been tested and found to comply with the limits for a Class B digital device pursuant to Part 15 of the FCC rules. These limits are designed to provide reasonable protection against harmful interference in a residential installation. This device generates, uses and can radiate radio frequency energy and, if not installed and used in accordance with the instructions, may cause harmful interference to radio communications.

However, there is no guarantee that interference will not occur in a particular installation. If this device does cause harmful interference to radio or television reception, which can be determined by turning the device off and on, the user is encouraged to try to correct the interference by one or more of the following measures:

- Reorient or relocate the receiving antenna.
- Increase the separation between the device and receiver.
- Connect the device into an outlet on a circuit different from that to which the receiver is connected.
- Consult the dealer or an experienced radio/television technician for help.

### **Notice: Shielded cables**

All connections to other computing devices must be made using shielded cables to maintain compliance with FCC regulations.

### **Caution**

Changes or modifications not expressly approved by the manufacturer could void the user's authority, which is granted by the Federal Communications Commission, to operate this projector.

## **Operation conditions**

This device complies with Part 15 of the FCC Rules. Operation is subject to the following two conditions:

1. This device may not cause harmful interference and
2. This device must accept any interference received, including interference that may cause undesired operation.

## **Notice: Canadian users**

This Class B digital apparatus complies with Canadian ICES-003.

## **Remarque à l'intention des utilisateurs canadiens**

Cet appareil numérique de la classe B est conforme à la norme NMB-003 du Canada.

## **Declaration of Conformity for EU countries**

- EMC Directive 2004/108/EC (including amendments)
- Low Voltage Directive 2006/95/EC
- R & TTE Directive 1999/5/EC (if product has RF function)

### **Disposal instructions**



**Do not throw this electronic device into the trash when discarding. To minimize pollution and ensure utmost protection of the global environment, please recycle it.**

# Optoma Wireless and Network control module User's Manual

<b>1. Overview</b> .....	<b>2</b>
<b>2. Quick Start</b> .....	<b>2</b>
<b>3. Client Utility</b> .....	<b>5</b>
3.1 Button Descriptions .....	5
3.2 Start/Stop Presentation .....	6
3.3 Start / Stop Playing Video/Music .....	7
3.4 Open Admin Web Page .....	8
3.5 Repeat.....	9
3.6 Searching Server .....	9
3.7 Magnifier Option .....	9
3.8 System Information.....	10
3.9 Exit Program.....	10
<b>4. WPS for Mac Client</b> .....	<b>11</b>
<b>5. Web Management</b> .....	<b>13</b>
5.1 Home Page.....	13
5.2 System Status.....	14
5.3 Network Setup .....	14
5.4 Projection Setup .....	17
5.5 Change Passwords .....	18
5.6 Reset to Default.....	18
5.7 Firmware Upgrade.....	19
5.8 Projection Control Panel.....	21
5.9 Alert Setting .....	21
5.10 Reboot System .....	22
5.11 Logout.....	22
<b>6. Mobishow</b> .....	<b>23</b>
6.1 Install from CD .....	23
6.2 Using MobiShow with a Smartphone .....	23
6.3 PtG Converter.....	30



# 1. Overview

Cable-free presenting with the Optoma wireless projector. Project presentations and video from a windows or Mac based PC device.

- 4-to-1 Split Screen Projection

With this 4-to-1 split screen feature, up to four PC screens can be projected on one projector screen at the same time. Allowing easy side-by-side comparison from four PCs to increase meeting productivity!

- Magnifier feature

Wireless projector supports Magnifier feature for a codec-free video clip watching experience. By resizing the video into the magnifier capture region, you will be able to watch any video on the big screen.

- Macintosh wireless Projection

Wireless Projector supports Mac client connections projecting wirelessly. By launching the Mac client software, which is stored on the User manual CD, wireless projector provides the same experience for Mac users to utilize the Wireless presentation features. Support Macintosh version 10.4 and above.

## ➤ Features

- Supports Windows Vista, XP & 2000.
- 4-to-1 split screen projection! Turn one projector into four, increase meeting productivity instantly.
- Provides session security login, wireless WEP key and Gatekeeper function to protect presentation contents and maintain effective security within office networks.
- Provides magnifier feature to enlarge small region for full-screen video playback.
- Provides a media playback feature, supporting both music and video streaming.

## 2. Quick Start

- 1) Firstly, plug in the wireless antenna and point it towards an unobstructed position, away from the projector. Check the LED light on the wireless module turns to green when AC power is supplied to the projector.

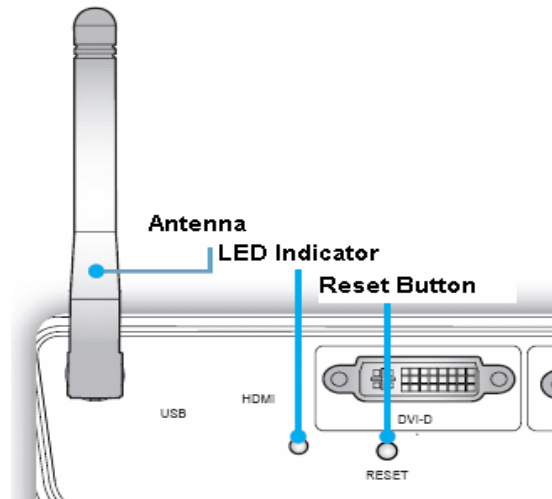

- 2) Press Wireless button on remote control, or select from On-Screen-Display (OSD) in Projector menu



- 3) When Projector shows the default screen, as below, it indicates the Wireless function is ready.

LOGIN CODE:1234



### Quick Guide

1. Make sure your WLAN is enabled, and connect to the Optoma AP.
2. Open your browser, or enter the IP address (refer to below server IP address)
3. Click on "Download", and execute the installation program.
4. Make sure your personal firewall allows Optoma software to pass through!
5. Click the "Play" button, and enter the LOGIN CODE to start projection!

---

SSID: Wireless Projector  
Server IP:192.168.100.10  
Channel: 6  
WEP: Disable  
Resolution:1024\*768  
Version:2.6.2.0

- 4) Make sure your PC/laptop WLAN is enabled and connected to the "wireless projector" network. Use the "Server IP" address to access the web-interface home page via a web browser. (default IP address is **192.168.100.10** )
- 5) Download the client software, and install the program. Click on the wireless icon to execute the program. When Wireless Projector IP is found, enter the "**Login Code**" (shown in the top-left corner of the projector screen) to start projecting wirelessly.

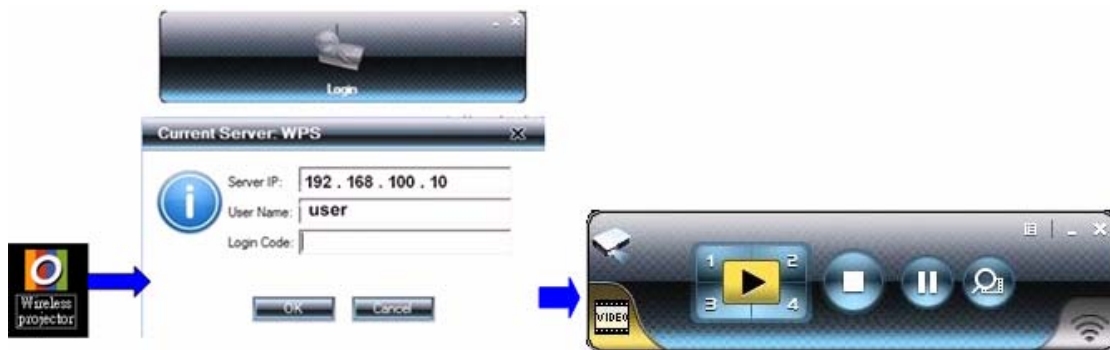

## 3. Client Utility

### 3.1 Button Descriptions

- 1) After successful login, you will see the main GUI of Wireless Projector application.



- 2) Use following buttons to operate Wireless Projector Application.



Presentation Mode



Video Mode



4-1 split-screen controls



Full Screen projection



Project to Split #1



Project to Split #2



Project to Split #3



Project to Split #4



Pause projecting



Stop projecting



Magnifier



5851 Server Login Code



While projecting is in progress, this icon will blink



Start Playing Video



Stop Playing Video



Open Video File



Mute Audio



Audio volume bar



Video transport bar



While playing video, this icon will blink



Function menu



Minimize the program



Exit the program

## 3.2 Start/Stop Presentation



Click  to project desktop (Full screen or split screen)



Click  to stop presentation.



Click  to pause presentation, which will hide any intermediate activities of your PC screen.



Click  to enable the magnifier feature. The software will enlarge and playback the image within the red rectangle to playback full screen, ie. You will need to resize the video window to fit into this rectangle.

NB. To enable this feature, you need to install Magnifier component and audio driver which are on the User Manual CD.

### 3.3 Start / Stop Playing Video/Music



Click  to switch to Video Mode.



Click  to browse for a video file to playback.

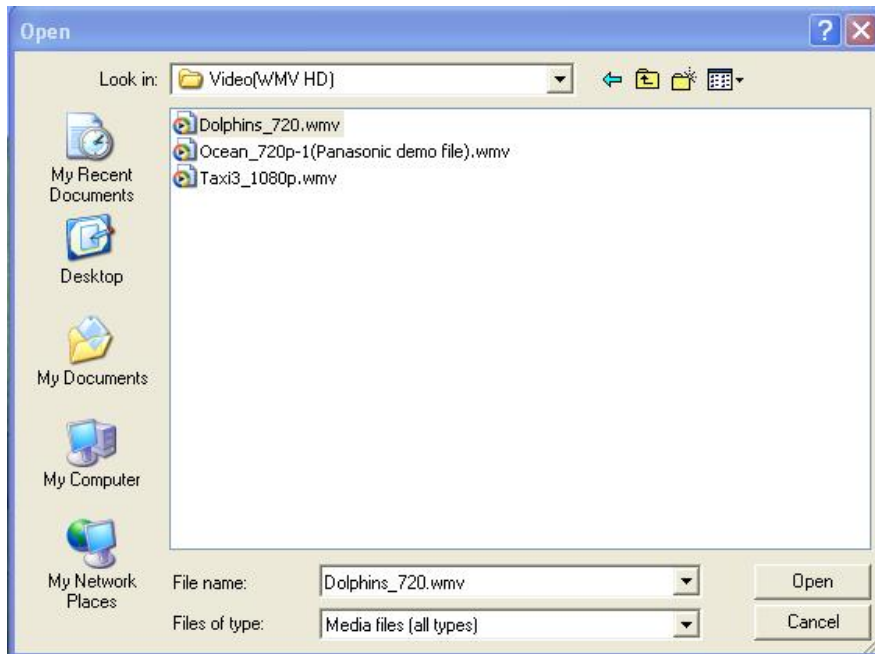

- Supported Video Format: MPG, MPEG, DAT, VOB, WMV9, ASF, MP3, WAV.

### 3.4 Open Admin Web Page

Click  to open function menu and select “**Web Admin**” management to link to the web interface home page. The web page functions are described in more detail in Chapter 5.

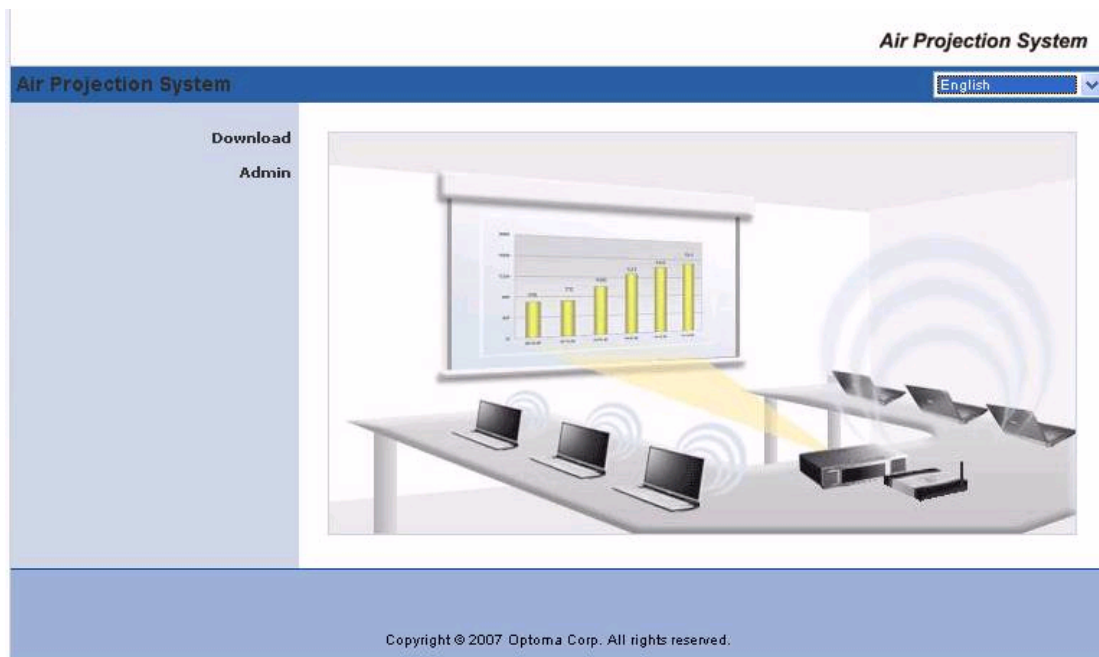
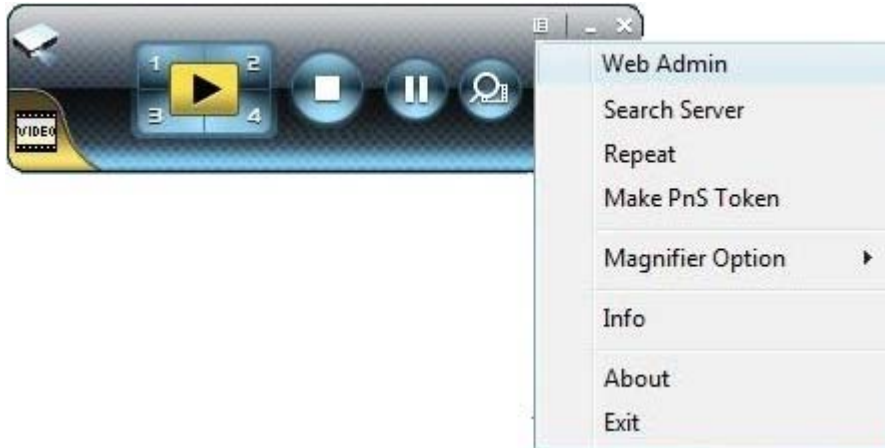

### 3.5 Repeat

Click “Repeat” to enable/disable video repeat capability.

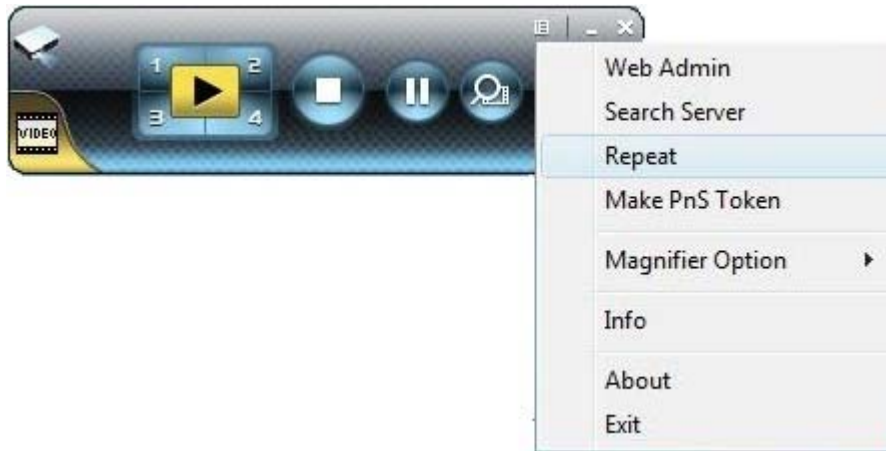

### 3.6 Searching Server

Click “Search Server” to search for Wireless Projectors again.

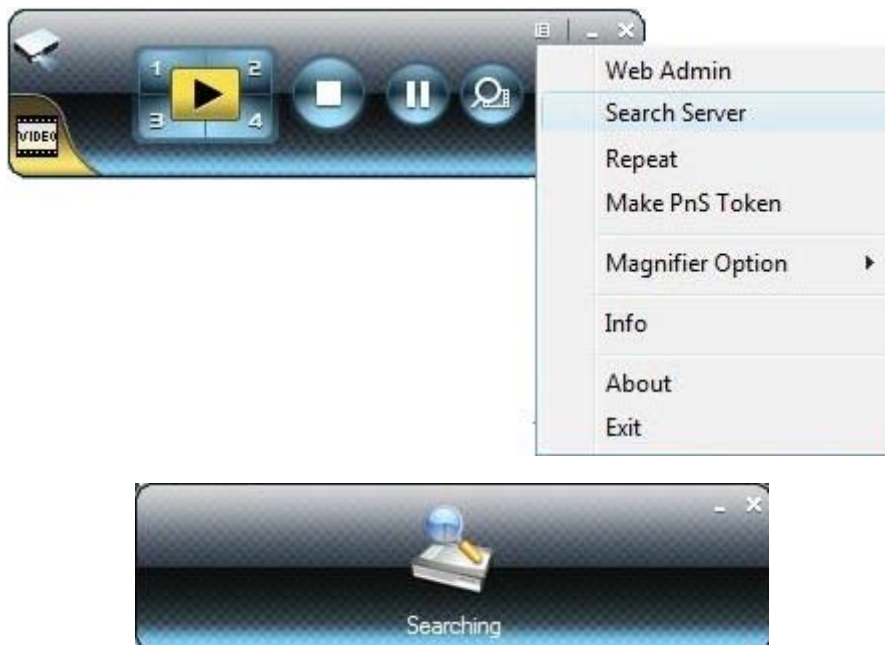

### 3.7 Magnifier Option

Use “Magnifier option” to change the aspect ratio of captured video region when using magnifier feature.





4:3 (320x240 pixels)



16:9 (355x220 pixels)

### 3.8 System Information

Click “Info” to show system information. It includes product model name, IP address and log-in code.



### 3.9 Exit Program

Click  to exit the program.

## 4. WPS for Mac Client

To project your Mac screen with Wireless Projector, please follow the steps:

- 1) Enable your WiFi and connect to Wireless Projector device.



- 2) Install Wireless Projector client software for Mac. (On User Manual CD)



- 3) Launch Wireless Projector software and enter the login code. (shown in the top-left corner of the projector screen)



4) Start Projection.



## 5. Web Management

### 5.1 Home Page

1. Make sure your PC connects to the Wireless Projector successfully.
2. Open your browser, it will load the Wireless Projector home page automatically.
3. If not, enter your IP address on the browser, you can see the IP on the projector screen. (The default IP is 192.168.100.10)

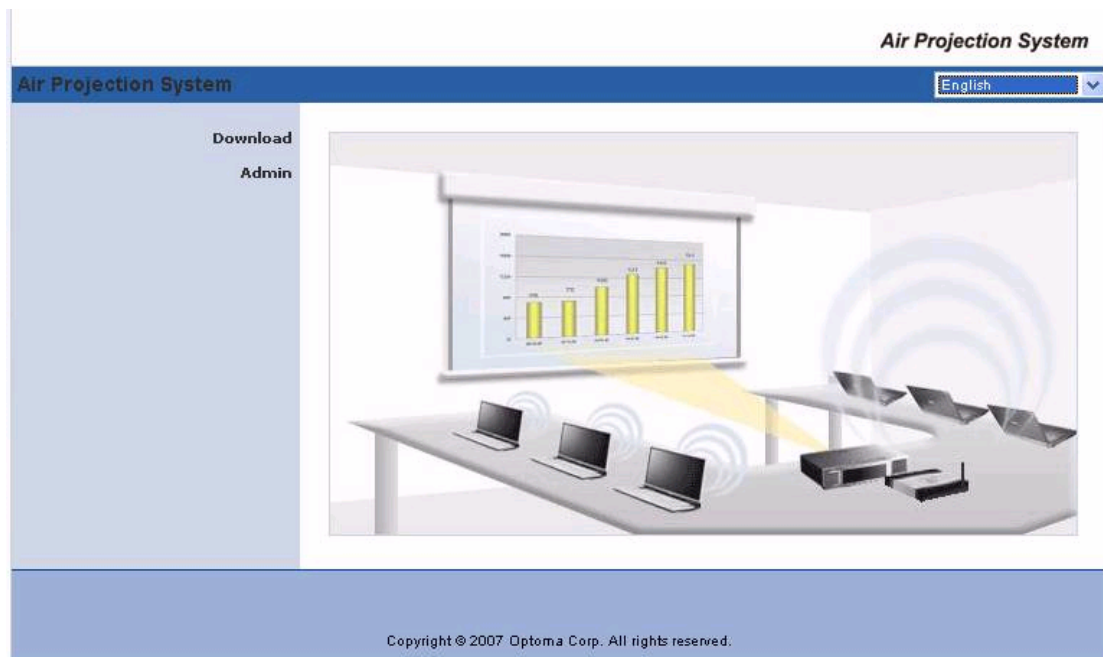

## 5.2 System Status

**Air Projection System**

Air Projection System > Admin > System Status Logout »

<b>System Status</b>	Model Name	Wireless projector
<b>Network Setup</b>	Versions	
<b>Projection Setup</b>	Firmware Version	0.0.0.8
<b>Change Passwords</b>	Network Status	
<b>Reset to Default</b>	IP Address	192.168.100.10
<b>Firmware Upgrade</b>	Subnet Mask	255.255.255.0
<b>Projector Control Panel</b>	Default Gateway	192.168.100.10
<b>Alert Setting</b>	Wireless MAC Address	00:22:5F:11:0D:5A
<b>Reboot System</b>	Connection Status	
	Projecting Status	Waiting for Projecting
	Total Users	0
	Projector Information	
	Projector Status	ON
	Source Select	Wireless
	Lamp Hours	0036
	Video Mode	Presentation
	Error Status	Invalid Command
	Firmware Version	C.06

Copyright © 2009 Optoma Corp. All rights reserved.

Click **[System Status]** to shows current system status.

**Model Name:** Product model name

**Versions:**

1. **Firmware version no.:** Wireless module firmware version number.

**Network Status:**

1. **IP address:** IP address of Wireless module.
2. **Subnet Mask:** subnet mask
3. **Default Gateway:** IP address of default gateway
4. **Wireless MAC address:** wireless MAC address

**Connection Status:**

1. **Projecting status:** either “Waiting for projecting” or “Projecting”
2. **Total Users:** It shows how many users login into Wireless Projector box.

## 5.3 Network Setup

There are many kinds of operating configurations as below.

**Air Projection System**

Air Projection System > Admin > Network Setup Logout »

System Status

Network Setup

Projection Setup

Change Passwords

Reset to Default

Firmware Upgrade

Projector Control Panel

Alert Setting

Reboot System

Obtain an IP address automatically  Use the following IP address

IP Address:

Subnet Mask:

Default Gateway:

Dns Server:

Auto  Disable

Start IP:

End IP:

Subnet Mask:

Default Gateway:

Dns Server:

Wireless Lan:  Enable  Disable

Region:

SSID: Wireless Projector

SSID Broadcast:  Enable  Disable

Channel:

WEP:

Key:

GateKeeper:  All Pass  All Block  Internet Only

Copyright © 2009 Optoma Corp. All rights reserved.

### < Auto-Configuration Network Setup >

The default setting of the Wireless Projector box is DHCP client. When the Wireless Projector box is connected to a LAN that already has a DHCP server present, the Wireless Projector box takes an IP address assigned to it by the server. When the Wireless Projector box is connected to a LAN that does not have a DHCP server, the Wireless Projector box becomes the DHCP server in the network.

### < IP Setup >

- ◆ You can select “obtain IP address automatically” or “Use the following IP address”
- ◆ IP Address: The default value is 192.168.100.10.
- ◆ Subnet Mask: The default value is 255.255.255.0
- ◆ Default Gateway: The default value is 192.168.100.10

### <DHCP Server Setup >

- ◆ You can select “auto(Enable/Disable DHCP Server” or “Disable”)
- ◆ Start IP: The start IP address of DHCP Server.

- ◆ End IP: The end IP address of DHCP Server.

#### < Wireless Setup >

- ◆ Region: default value is "Worldwide".
- ◆ SSID: SSID string, max. Length is 32 bytes.
- ◆ Channel: to set fixed channel or Auto. The "Auto" means after power on Wireless Projector, it will scan all of wireless channel and select clear one channel automatically.
- ◆ WEP: you can Disable WEP key or select one of 64bit or 128bit in ASCII or HEX string.
- ◆ Key: If WEP is enabled, you have to set key value according to WEP mode you selected.

#### < Gatekeeper >

Gatekeeper is designed for ensuring the enterprise network security within Wireless Projector box

- ◆ All Block can block Guest Users(through wireless) to access all office network(LAN),
- ◆ All Allow can pass Guest Users(through wireless) to access all office network
- ◆ Internet Only can block Guest Users (through wireless) from office network (LAN) but still reserve internet connection capability.

<Apply >: press button to select this mode

<Cancel>: press button to abort action.

<Back>: Back to Operating mode main menu



## 5.4 Projection Setup

The screenshot shows the 'Air Projection System' Admin interface. The breadcrumb navigation is 'Air Projection System > Admin > Projection Setup'. A 'Logout' link is in the top right. A left sidebar contains menu items: System Status, Network Setup, Projection Setup (highlighted), Change Passwords, Reset to Default, Firmware Upgrade, Projector Control Panel, Alert Setting, and Reboot System. The main content area is titled 'Projection Setup' and contains the following fields:

Resolution	XGA (1024x768)
Color Depth	Normal (16 bit)
Screen Refresh Rate	60 Hz
Login Code	<input type="radio"/> Disable <input checked="" type="radio"/> Random <input type="radio"/> Use the following code <input type="text"/>
Model Name	OPTOMA
Projector Name	AWIND

Buttons for 'Apply' and 'Cancel' are located at the bottom right of the form area. The footer contains the text: 'Copyright © 2009 Optoma Corp. All rights reserved.'

Click [**Projection Setup**] button

- ◆ **<Resolution>**: 1024\*768, 1280x768 and 800\*600.
- ◆ **<Color Depth>**: provide Wireless Projector output with 16bit or 32 bit color depth. It depends on your PC settings.
- ◆ **<Screen Refresh Rate>**: This is VGA output refresh rate, provides both 60 Hz and 75Hz.
- ◆ **<Login Code>**: You can select “Disable”, “Random”, or “Use the following code” to set a specific 4-digit number.
- ◆ **<Apply>** : Confirm and Save modifications
- ◆ **<Cancel>**: Cancel all the modifications



## 5.5 Change Passwords

Air Projection System > Admin > User Settings Logout »

System Status  
Network Setup  
Projection Setup  
**Change Passwords**  
Reset to Default  
Firmware Upgrade  
Projector Control Panel  
Alert Setting

Reboot System

Download

Enter New Password

Confirm New Password

Admin

Enter New Password

Confirm New Password

Copyright © 2009 Optoma Corp. All rights reserved.

Click [**Change Password**] button, to change password.

- ◆ **<Enter New Password>**: enter new password you want to change for each category.
- ◆ **<Confirm New Password>**: double check new password.
- ◆ **<Apply>**: Confirm and Save modifications.

## 5.6 Reset to Default

Air Projection System > Admin > Reset to Default Logout »

System Status  
Network Setup  
Projection Setup  
Change Passwords  
**Reset to Default**  
Firmware Upgrade  
Projector Control Panel  
Alert Setting

Reboot System

 **Reset to Default**  
This will restore the device to the factory default settings.

Copyright © 2009 Optoma Corp. All rights reserved.

Click [**Reset to Default**] button to restore factory default settings.

**<Apply>**: Confirm reset.

\*\*\* Another way to restore Factory Default Settings, follow the procedure below:

- 1) Press **[Reset]** button and **Hold**.
- 2) Turn on Wireless Projector box.
- 3) Wait for over 10 seconds and release **[Reset]** button.
- 4) It will take effect to restore factory default settings.

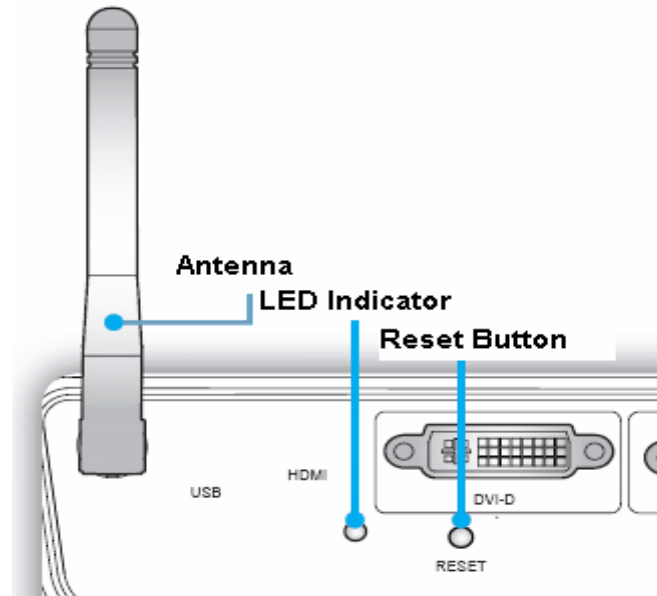

## 5.7 Firmware Upgrade

*Air Projection System*

Air Projection System > Admin > Firmware Upgrade Logout »

<b>System Status</b>	Firmware Version	0.0.0.8
<b>Network Setup</b>	Release Date	20090202
<b>Projection Setup</b>	After you apply "Upgrade" button, projecting function will be terminated.	
<b>Change Passwords</b>	Warning: Once you've upgraded to the new version of firmware, you will not be able to roll back to the previous version!	
<b>Reset to Default</b>	File Name	<input type="text"/> <input type="button" value="浏览..."/>
<b>Firmware Upgrade</b>	<input type="button" value="Upgrade"/>	
<b>Projector Control Panel</b>		
<b>Alert Setting</b>		
<input type="button" value="Reboot System"/>		

Copyright © 2009 Optoma Corp. All rights reserved.

Click **[Firmware Upgrade]** button to upgrade firmware.

- 1) Ensure you have acquired the latest firmware to download.
- 2) Click <Brow> to specify file name you want to upgrade.
- 3) Click <Upgrade> button to upgrade the firmware.
- 4) A warning message with the estimated time for completion will appear on the screen.
- 5) After a few minutes, a “complete” message will be shown on the screen.
- 6) Upon the completion of firmware upgrade, manually power off the projector and on again.

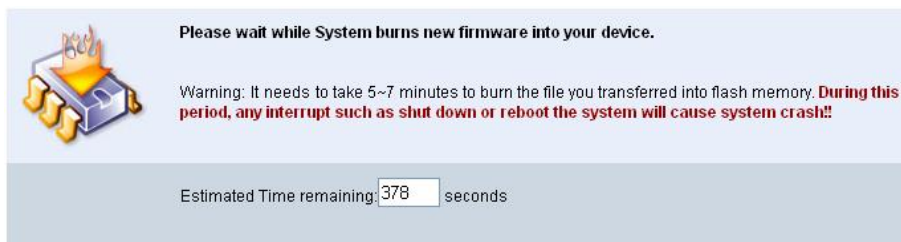

 **Warning:** DO NOT power off Wireless Projector while firmware upgrade is in progress. This will cause the wireless projector to fail and recovery process cannot be performed.

## 5.8 Projection Control Panel

The screenshot displays the 'Air Projection System' Admin interface, specifically the 'Projector Control Panel'. The top navigation bar includes 'Air Projection System > Admin > Projector Control Panel' and a 'Logout' button. A left sidebar lists navigation options: System Status, Network Setup, Projection Setup, Change Passwords, Reset to Default, Firmware Upgrade, Projector Control Panel (highlighted), and Alert Setting. Below the sidebar, the 'Projector Information' section contains various controls:

- Power On** and **Power Off** buttons.
- Freeze** and **Unfreeze** buttons.
- ReSYNC.** button.
- Reset** button.
- Logo Capture** button.
- AV mute** (OFF), **Bright Mode** (ON), **Information Hide** (ON), **High Altitude** (OFF), **Keypad Lock** (OFF), **Direct Power ON** (OFF), and **Eco. Standby** (OFF) settings.
- Source**: Wireless (dropdown).
- Volume**: 20 (slider).
- Brightness**: 50 (slider).
- Contrast**: 50 (slider).
- Sharpness**: 16 (slider).
- V keystone**: 0 (slider).
- Degama**: Graphics (dropdown).
- Color temp**: med (dropdown).
- Display Mode**: Presentation (dropdown).
- Color Space**: Auto (dropdown).
- Display Format**: Auto (dropdown).
- Zoom**: 0 (slider).
- V Image Shift**: 50 (slider).
- Projection way**: front (dropdown).
- Auto Power Off**: 15 (slider).
- Sleep Timer**: 0 (slider).
- Background Color**: Black (dropdown).
- Logo**: Optoma (dropdown).

## 5.9 Alert Setting

This option can be used to automatically send email alerts regarding various warning functions of the projector, including email alerts.

**Air Projection System**

**Air Projection System > Admin > Alert Setting** Logout »

System Status

Network Setup

Projection Setup

Change Passwords

Reset to Default

Firmware Upgrade

Projector Control Panel

Alert Setting

 **Reboot System**

**E-Mail Alert**

E-Mail Alert  Enable  Disable

To:

Cc:

From:

Subject:

**SMTP Setting**

Out going SMTP Server:

Username:

Password:

Fan Lock

Out of Range

Lamp hours running out

Projector over-heating

Lamp Fail

Copyright © 2009 Optoma Corp. All rights reserved.

## 5.10 Reboot System

Click **[Reboot System]** button to restart system

**<Reboot>**: Restarts the system automatically.

## 5.11 Logout

Click **[logout]** to return back to the Web homepage.

## 6. Mobishow

### 6.1 Install from CD

- 1) Connect your personal portable device to PC. For example, if the operating system is Windows Mobile (v5.1 or above), please ensure it is connected in ActiveSync.
- 2) Copy the Mobishow \*.CAB installation file from the User manual CD to your mobile device.
- 3) Run the installation file from your device operating system using “**File explorer**” and follow the on-screen instructions.
- 4) When prompted, check the screen of your device to finish installation on your portable device.

### 6.2 Using MobiShow with a Personal Portable

#### Device/Smart phone

- 1) Open “**Programs**” on your device and find “**MobiShow**” application.
- 2) Select “**MobiShow**” icon  to launch the client software.
- 3) MobiShow will turn on Wi-Fi on your device and list available access points for you to choose.



- 4) Select the Mobishow enabled Wireless Projector you wish to connect to (Default SSID is "Wireless Projector")
- 5) MobiShow client will connect to that access point and search for MobiShow devices automatically. When a MobiShow device is found, you will need to enter the 4-digit login code from the projector's wireless start-up screen.

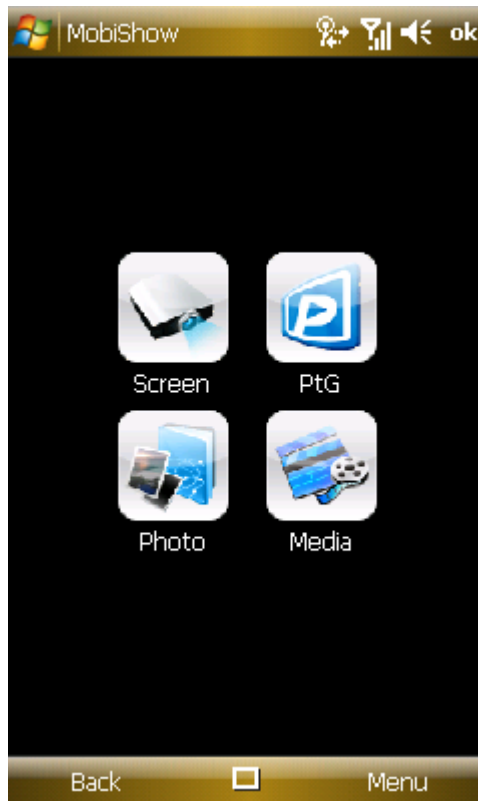

- If more than one MobiShow devices are found, the following list will be displayed for selection.





- 6) Select which feature to use. To project the screen of your phone, click on the “**Screen**” icon. To do a PC-less presentation with Presentation-to-Go (PtG), select the “**PtG**” icon. To show a slideshow of images or photos, select “**Photo**” icon. To play a video or MP3 from your device, select the “**Media**” icon.

● **Screen Projection:**

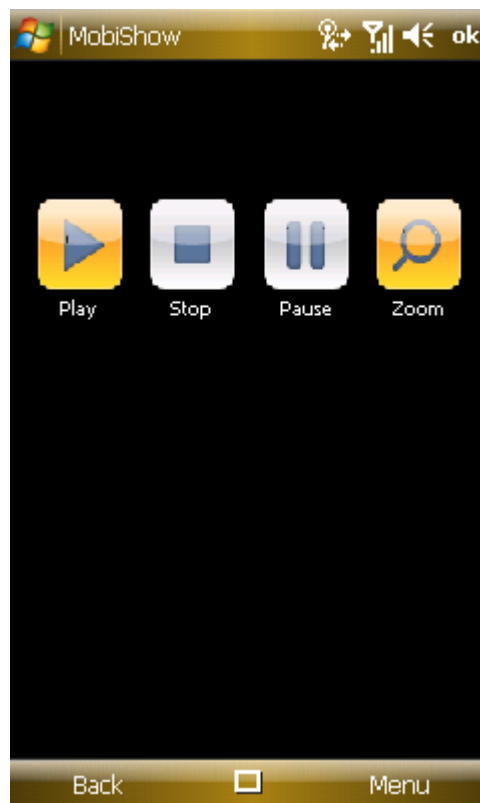

MobiShow will project anything displayed on your screen. You may launch another application (such PowerPoint Viewer) or open any file (such as Word document or JPG image) and it will be projected to the projector.  
*Note: Do not exit MobiShow application while opening other applications to keep screen projected.*

Click the “**Stop**” icon to stop projection.

Click the “**Pause**” icon to pause projection. Click “**Pause**” again to resume projection.

Click the “**Zoom**” icon to zoom the projected screen to extend the longest

side of your screen to fill the screen.

Click the “**Play**” icon to start projection again if it is stopped.

Click the “**OK**” button or “**Back**” to return to main menu.

- **Wireless PtG:**

When you select PtG function, MobiShow client will automatically open Explorer for you to select a PtG file. Select the file to open for your presentation. When the file is open, the PtG slides will be projected, and the following screen is displayed on your phone for you to control your PtG presentation.



Click “**Prev**” or “**Next**” to go to the previous or next item in the slide.

Click “**PgUp**” or “**PgDn**” to go to previous or next slide.

Click “**Stop**” to stop projecting the file. The icon will become “**Play**” if the file is not played. Click “**Play**” again to play the file if it is stopped.

Click “**Home**” to go to the first slide.

Click “**Jump**” and MobiShow client will show every slide on the phone. You can select any page to go to, then click “**ok**”.

Click “**Open**” to select another PtG file.

● **Photo Slideshow:**

You can use MobiShow to project photos stored on your portable device to big screen. The photos will be prepared for playback on big screens rather than for the tiny screens of your device.

To open a single photo, select one photo and click the OK button. The photo will be displayed on the display connected to MobiShow device.

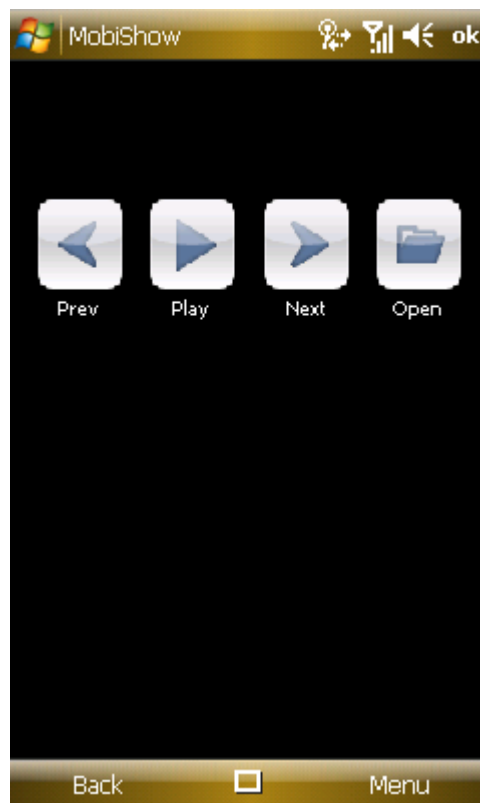

Click “**Prev**” or “**Next**” to go to the previous or next photo in the same folder.

Click “**Play**” to start photo slideshow with photos in the same folder. The button will be changed to “**Pause**” during slideshow. Click “**Pause**” to

stop slideshow.

- **Media Sender:**

When you select Media Sender function, MobiShow client will automatically open Explorer for you to select a media file. Select a file (videos in mpeg or wmv9 format, or MP3 music files) to play. The file will be streamed to MobiShow device. It may take a few seconds to buffer before the playback begins, depending on the wireless signal and media bit rate.

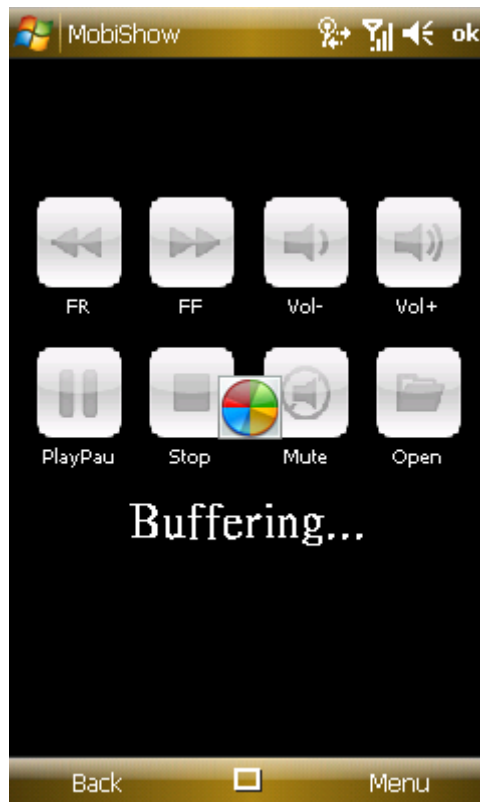

When the file is open, the media will be projected, and the following screen is displayed on the device for you to control your media playback.

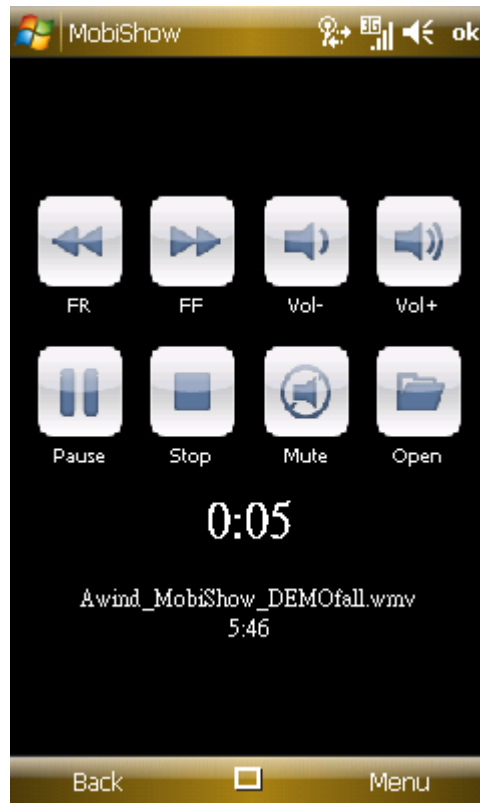

Click “**FR**” or “**FF**” to seek backward or forward.

Click “**Vol-**” or “**Vol+**” to adjust volume for playback.

Click “**Stop**” to stop playing the file. The icon will become “**Play**” if the file is not played. Click “**Play**” again to play the file if it is stopped.

Click “**Mute**” to mute the audio. Click “**Mute**” again to bring audio back.

Click “**Open**” to select another media file.

7) When you are in the main menu, click the “**OK**” button or “**Back**” again to close the application.

## 6.3 PtG Converter

Use this software to convert Microsoft™ Powerpoint presentations into

“Presentation-to-Go” (\*.PtG) files for use on mobile devices. The installation wizard can be found on the User Manual CD.

- 1) Once installed, launch the application and the following GUI will appear



- 2) Click  to set the maximum duration of animations in the slideshow (between 10 and 60 seconds), find out more about the software, or exit.

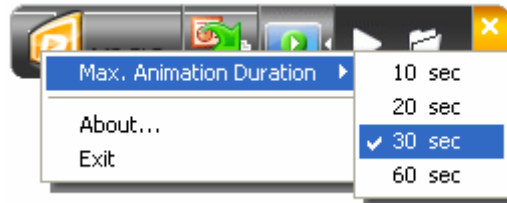

- 3) Click  to select the PPT file you wish to convert to PtG.
- 4) Enter or browse for the desired output directory and filename, then click OK.

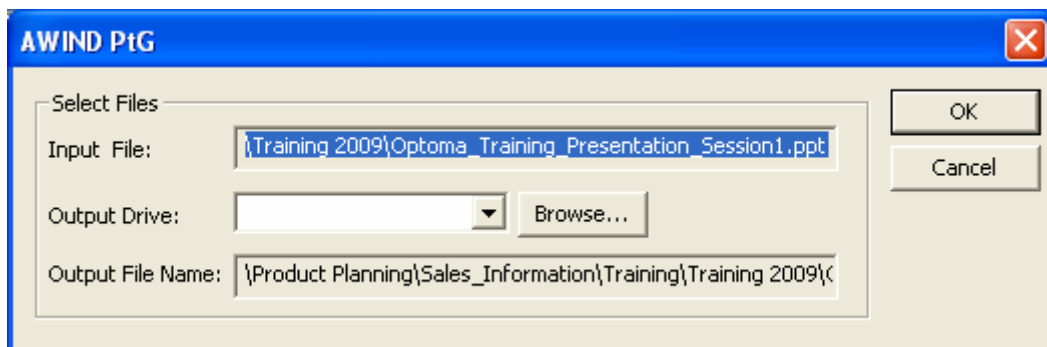

- 5) The software will then convert your presentation into a single PtG file - a progress bar is shown at the top of the screen. Once complete, the following message will appear:

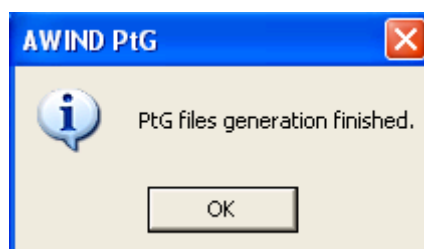

6) Once created, use the following controls to Open and Preview your PtG files.



7) While previewing the slideshow, use the following controls to move through the presentation.



Previous slide



Options



Exit Slideshow



Next Slide

13 / 15

Presentation Progress