

# 802-VLZ3

## 8-Channel Premium Mic/Line Mixer

### OWNER'S MANUAL

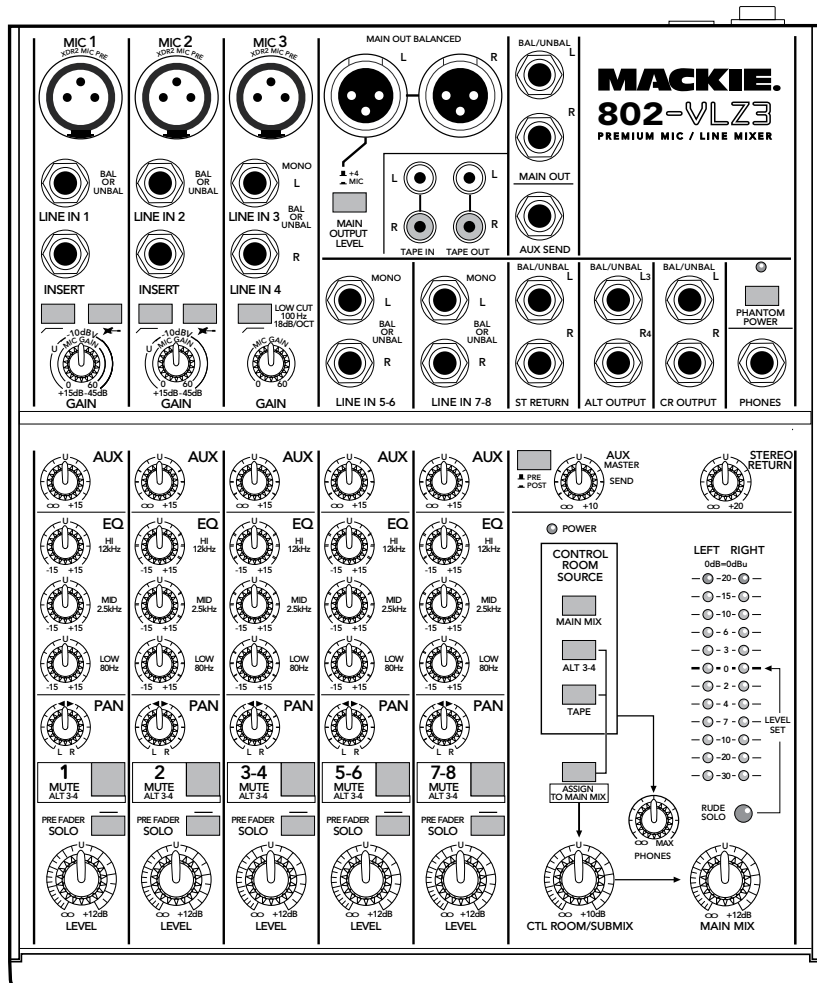
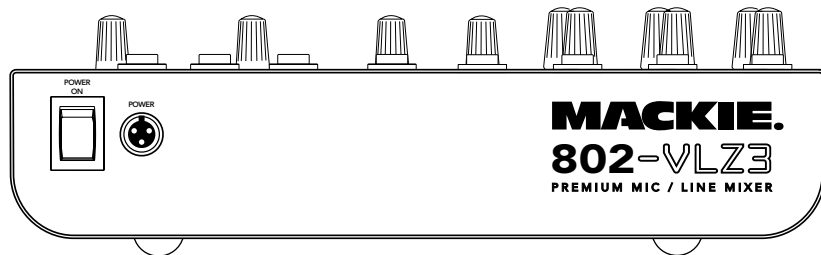

# Important Safety Instructions

1. Read these instructions.
2. Keep these instructions.
3. Heed all warnings.
4. Follow all instructions.
5. Do not use this apparatus near water.
6. Clean only with dry cloth.
7. Do not block any ventilation openings. Install in accordance with the manufacturer's instructions.
8. Do not install near any heat sources such as radiators, heat registers, stoves, or other apparatus (including amplifiers) that produce heat.
9. Do not overload wall outlets and extension cords as this can result in a risk of fire or electric shock.
10. Protect the power cord from being walked on or pinched particularly at plugs, convenience receptacles, and the point where they exit from the apparatus.
11. Only use attachments/accessories specified by the manufacturer.
12. Use only with a cart, stand, tripod, bracket, or table specified by the manufacturer, or sold with the apparatus. When a cart is used, use caution when moving the cart/apparatus combination to avoid injury from tip-over.
13. Unplug this apparatus during lightning storms or when unused for long periods of time.
14. Refer all servicing to qualified service personnel. Servicing is required when the apparatus has been damaged in any way, such as power-supply cord or plug is damaged, liquid has been spilled or objects have fallen into the apparatus, the apparatus has been exposed to rain or moisture, does not operate normally, or has been dropped.
15. This apparatus shall not be exposed to dripping or splashing, and no object filled with liquids, such as vases or beer glasses, shall be placed on the apparatus.
16. This apparatus has been equipped with a 2-pole, rocker-style power switch. This switch is located on the rear panel and should remain readily accessible to the user.
17. **WARNING:** Plug the power cord into a power outlet where access to the power cord connector is readily accessible in case power disconnection is required.
18. **ATTENTION:** This device complies with Part 15 of the FCC Rules. Operation is subject to the following two conditions: 1) This device may not cause harmful interference, and 2) This device must accept any interference received, including interference that may cause undesired operation.
19. This apparatus does not exceed the Class A/Class B (whichever is applicable) limits for radio noise emissions from digital apparatus as set out in the radio interference regulations of the Canadian Department of Communications.

**ATTENTION** — *Le présent appareil numérique n'émet pas de bruits radioélectriques dépassant les limites applicables aux appareils numériques de class A/de class B (selon le cas) prescrites dans le règlement sur le brouillage radioélectrique édicté par les ministères des communications du Canada.*

20. Exposure to extremely high noise levels may cause permanent hearing loss. Individuals vary considerably in susceptibility to noise-induced hearing loss, but nearly everyone will lose some hearing if exposed to sufficiently intense noise for a period of time. The U.S. Government's Occupational Safety and Health Administration (OSHA) has specified the permissible noise level exposures shown in the following chart.

According to OSHA, any exposure in excess of these permissible limits could result in some hearing loss. To ensure against potentially dangerous exposure to high sound pressure levels, it is recommended that all persons exposed to equipment capable of producing high sound pressure levels use hearing protectors while the equipment is in operation. Ear plugs or protectors in the ear canals or over the ears must be worn when operating the equipment in order to prevent permanent hearing loss if exposure is in excess of the limits set forth here.



Duration, per day in hours	Sound Level dBA, Slow Response	Typical Example
8	90	Duo in small club
6	92	
4	95	Subway Train
3	97	
2	100	Very loud classical music
1.5	102	
1	105	Dave screaming at Steve about deadlines
0.5	110	
0.25 or less	115	Loudest parts at a rock concert

**WARNING** — To reduce the risk of fire or electric shock, do not expose this apparatus to rain or moisture.

## PORTABLE CART WARNING



Carts and stands - The Component should be used only with a cart or stand that is recommended by the manufacturer. A Component and cart combination should be moved with care. Quick stops, excessive force, and uneven surfaces may cause the Component and cart combination to overturn.

	<b>CAUTION AVIS</b>	
RISK OF ELECTRIC SHOCK DO NOT OPEN RISQUE DE CHOC ELECTRIQUE NE PAS OUVRIR		
CAUTION: TO REDUCE THE RISK OF ELECTRIC SHOCK DO NOT REMOVE COVER (OR BACK) NO USER-SERVICEABLE PARTS INSIDE REFER SERVICING TO QUALIFIED PERSONNEL ATTENTION: POUR EVITER LES RISQUES DE CHOC ELECTRIQUE, NE PAS ENLEVER LE COUVERCLE. AUCUN ENTRETIEN DE PIECES INTERIEURES PAR L'USAGER. CONFIER L'ENTRETIEN AU PERSONNEL QUALIFIE. AVIS: POUR EVITER LES RISQUES D'INCENDIE OU D'ELECTROCUTION, N'EXPOSEZ PAS CET ARTICLE A LA PLUIE OU A L'HUMIDITE		



The lightning flash with arrowhead symbol within an equilateral triangle is intended to alert the user to the presence of uninsulated "dangerous voltage" within the product's enclosure, that may be of sufficient magnitude to constitute a risk of electric shock to persons.  
Le symbole éclair avec point de flèche à l'intérieur d'un triangle équilatéral est utilisé pour alerter l'utilisateur de la présence à l'intérieur du coffret de "voltage dangereux" non isolé d'ampleur suffisante pour constituer un risque d'électrocution.



The exclamation point within an equilateral triangle is intended to alert the user of the presence of important operating and maintenance (servicing) instructions in the literature accompanying the appliance.  
Le point d'exclamation à l'intérieur d'un triangle équilatéral est employé pour alerter les utilisateurs de la présence d'instructions importantes pour le fonctionnement et l'entretien (service) dans le livret d'instruction accompagnant l'appareil.

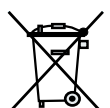

# Read This Page!

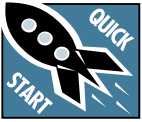

We realize that you can hardly resist the impulse to try out your new 802-VLZ3. All we ask is that you read this page NOW, and the rest can wait until you're good and ready. But do read it — you'll be glad you did.

## Level-Setting Procedure

Message to seasoned pros: do not set levels using the old "Turn the gain up until the clip light comes on, then back off a hair" trick. When a Mackie mixer clip light comes on, you really are about to clip. We worked and slaved to come up with a better system, one that provides low noise and high headroom.

### Adjusting input levels (Chs. 1–3 only)

On the first three channels, it's not even necessary to hear what you're doing to set the optimal levels. But if you'd like to: Plug headphones into the phones jack, then set the phones knob about one-quarter of the way up.

The following steps must be performed one channel at a time:

1. Turn the gain, level and aux send knobs fully down (counterclockwise).
2. Set the EQ knobs at the center detent.
3. Connect the signal source to the input.
4. Engage (push in) the solo switch.
5. Play something into the selected input. This could be an instrument, a singing or speaking voice, or a line input such as a CD player or tape recorder output. Be sure that the volume of the input is the same as it would be during normal use. If it isn't, then you might have to readjust these levels during the middle of the set.
6. Adjust the channel's gain control so that the meter display stays around "0" and never goes higher than "+6."
7. If you'd like to apply some EQ, do so now and return to step 6.
8. Disengage that channel's solo switch.
9. Repeat for each of channels 1 through 3. Note that channel 3's gain control only affects the mic input, not the line inputs.

## Instant Mixing

Here's how to get going right away, assuming you have a microphone and a keyboard:

1. Plug your microphone into channel 1's mic input.
2. Turn on the 802-VLZ3.
3. Perform the level-setting procedure.
4. Connect cords from the main outs (XLR, 1/4" or RCA, your choice) to your amplifier.
5. Hook up speakers to the amp and turn it on.
6. Turn up the 802-VLZ3's channel 1 level knob to the center, and the main mix knob one quarter of the way up.
7. Sing like a canary!
8. Plug your keyboard into stereo channel 5-6.
9. Turn that channel's level knob to the center.
10. Play like a madman and sing like a canary!  
It's your first mix!

## Other Notes

For optimum sonic performance, the channel level knobs and the main mix knob should be set near the "U" (unity gain) markings.

Always turn the main mix, control room/submix, and phones level controls down before making connections to and from your 802-VLZ3.

If you shut down your equipment, turn off your amplifier or powered speakers first. When powering up, turn them on last.

Save the shipping box! You may need it someday.

**Please write your serial number here for future reference (i.e., insurance claims, tech support, return authorization, make dad proud, etc.)**

**Purchased at:**

**Date of purchase:**

# Introduction

Thank you for choosing a Mackie professional compact mixer. The 802-VLZ3 is equipped with three of our precision-engineered XDR2™ Extended Dynamic Range premium studio-grade microphone preamplifiers.

The small size of this mixer and the quality of its design make it an ideal choice for recording, sound reinforcement, multimedia use, or post-production work. Tuck it away in your home studio and use the included Traktion software to record your wonderful talent.

The Mackie VLZ3 series of mixers consist of the 402, 802, 1202, 1402, 1642, and 1604-VLZ3. The 802-VLZ3 mixer has more channels than a four channel mixer, but not as many as a 12 channel mixer. Some of the features of the 802-VLZ3 include:

- Ultra-compact 8-channel mixer
- 3 studio-grade XDR2™ Extended Dynamic Range mic preamps
- 8 high-headroom line inputs
- 2 mono mic/line channels
- 1 mono-mic/stereo-line hybrid channel
- 2 stereo line-level channels
- Tape input and output with RCA connectors
- XLR main output with switchable mic-level output for direct connection to stage snake
- 1/4" TRS main outputs
- 3-band active EQ on each channel
- Aux send per channel, with master pre/post switch and dedicated stereo aux return
- Instrument input switches on channels 1 and 2 – no DI box is needed
- Inserts on channels 1 and 2
- Pan control on each channel
- Low-cut filter on mic input channels
- Phantom power for studio condenser mics
- Separate main, control room, and phones outputs with independent volume controls
- Control room/phones source matrix allows monitoring of any combination of main mix and tape input
- Pre-Fader solo on each channel
- ALT 3/4 stereo bus for added versatility
- High-resolution 12-segment stereo meters
- Sealed rotary controls to resist dust, grime and anchovies
- Sleek, rugged steel chassis

- Includes Traktion 3 Project Bundle, music production software for Mac/PC
- Optional mic stand adapter (see p.24)

## How To Use This Manual

Since many of you folks will want to hook up your 802-VLZ3 immediately, the first pages you will encounter after the table of contents are the ever-popular hookup diagrams. These show typical mixer setups for various applications.

After this section is a detailed tour of the entire mixer, where you will find illustrations with each feature numbered. If you're curious about a feature, simply locate it on the appropriate illustration, notice the number attached to it, and find that number in the nearby paragraphs.



This icon marks information that is critically important or unique to the 802-VLZ3. We recommend that you read these important notes.



This icon will lead you to in-depth explanations of features and some practical tips. It is possible these may even be helpful.

Appendix A is a section on troubleshooting and service information.

Appendix B is a section on connectors.

Appendix C shows the technical specifications, and a handy block diagram.

## Traktion

Not only do you get a shiny new 802-VLZ3 mixer, but you also get a copy of our wonderful Traktion 3 software. Traktion is not required to run the mixer, but once you start using it, you will just love it.

Traktion is a powerful audio production and MIDI sequencing application, designed with simplicity and ease of use in mind. It can be easily loaded onto your PC or Mac, and configured for your system. It is capable of delivering professional results that only a few years ago would have required a significant investment in expensive hardware. When you open Traktion, you have at your disposal all of the tools necessary to turn your musical ideas into great sounding mixes.

The Traktion DVD-ROM and authorization code is supplied with your 802-VLZ3. See [www.mackie.com](http://www.mackie.com) for system requirements and more Traktion details.

User's forums and entire audio civilizations have grown up around Traktion, so we hope that you will enjoy it and your new 802-VLZ3 mixer.

# Contents

<b>IMPORTANT SAFETY INSTRUCTIONS .....</b>	<b>2</b>	<b>OUTPUT SECTION.....</b>	<b>19</b>
<b>READ THIS PAGE!.....</b>	<b>3</b>	<b>29. MAIN MIX .....</b>	<b>19</b>
<b>INTRODUCTION .....</b>	<b>4</b>	<b>30. CONTROL ROOM SOURCE MATRIX.....</b>	<b>19</b>
<b>HOOKUP DIAGRAMS.....</b>	<b>6</b>	<b>31. PHONES .....</b>	<b>19</b>
<b>PATCHBAY DESCRIPTION .....</b>	<b>11</b>	<b>32. CONTROL ROOM/SUBMIX .....</b>	<b>19</b>
<b>1. MIC INPUTS (CHANNELS 1–3).....</b>	<b>11</b>	<b>33. ASSIGN TO MAIN MIX.....</b>	<b>20</b>
<b>2. LINE INPUTS (CHANNELS 1–2).....</b>	<b>12</b>	<b>34. RUDE SOLO.....</b>	<b>20</b>
<b>3. STEREO LINE INPUTS .....</b>	<b>12</b>	<b>35. METERS .....</b>	<b>20</b>
<b>4. CHANNEL INSERT (CHANNELS 1–2).....</b>	<b>12</b>	<b>36. PRE OR POST (AUX) .....</b>	<b>21</b>
<b>5. LOW CUT (CHANNELS 1–3).....</b>	<b>13</b>	<b>37. AUX MASTER SEND .....</b>	<b>21</b>
<b>6. INSTRUMENT SWITCH (CHANNELS 1–2)..</b>	<b>13</b>	<b>38. STEREO RETURN .....</b>	<b>21</b>
<b>7. GAIN (CHANNELS 1–3) .....</b>	<b>13</b>	<b>39. POWER LED .....</b>	<b>21</b>
<b>8. STEREO RETURN .....</b>	<b>13</b>	<b>APPENDIX A: SERVICE INFORMATION .....</b>	<b>22</b>
<b>9. ALT 3–4 OUTPUT .....</b>	<b>13</b>	<b>APPENDIX B: CONNECTIONS.....</b>	<b>23</b>
<b>10. CONTROL ROOM OUTPUTS.....</b>	<b>14</b>	<b>APPENDIX C: TECHNICAL INFORMATION .....</b>	<b>25</b>
<b>11. PHONES .....</b>	<b>14</b>	<b>802-VLZ3 LIMITED WARRANTY.....</b>	<b>27</b>
<b>12. PHANTOM SWITCH AND LED .....</b>	<b>14</b>		
<b>13. TAPE INPUT .....</b>	<b>14</b>		
<b>14. TAPE OUTPUT .....</b>	<b>15</b>		
<b>15. AUX SEND .....</b>	<b>15</b>		
<b>16. ¼" MAIN OUTS .....</b>	<b>15</b>		
<b>17. XLR MAIN OUTS .....</b>	<b>15</b>		
<b>18. XLR MAIN OUTPUT LEVEL SWITCH.....</b>	<b>15</b>		
<b>19. POWER CONNECTION.....</b>	<b>15</b>		
<b>20. POWER SWITCH.....</b>	<b>15</b>		
<b>CHANNEL STRIP DESCRIPTION.....</b>	<b>16</b>		
<b>21. LEVEL .....</b>	<b>16</b>		
<b>22. PRE-FADER SOLO .....</b>	<b>16</b>		
<b>23. MUTE/ALT 3–4 .....</b>	<b>16</b>		
<b>24. PAN.....</b>	<b>17</b>		
<b>25. LOW EQ.....</b>	<b>17</b>		
<b>26. MID EQ.....</b>	<b>17</b>		
<b>27. HI EQ.....</b>	<b>17</b>		
<b>28. AUX .....</b>	<b>18</b>		

# Hookup Diagrams

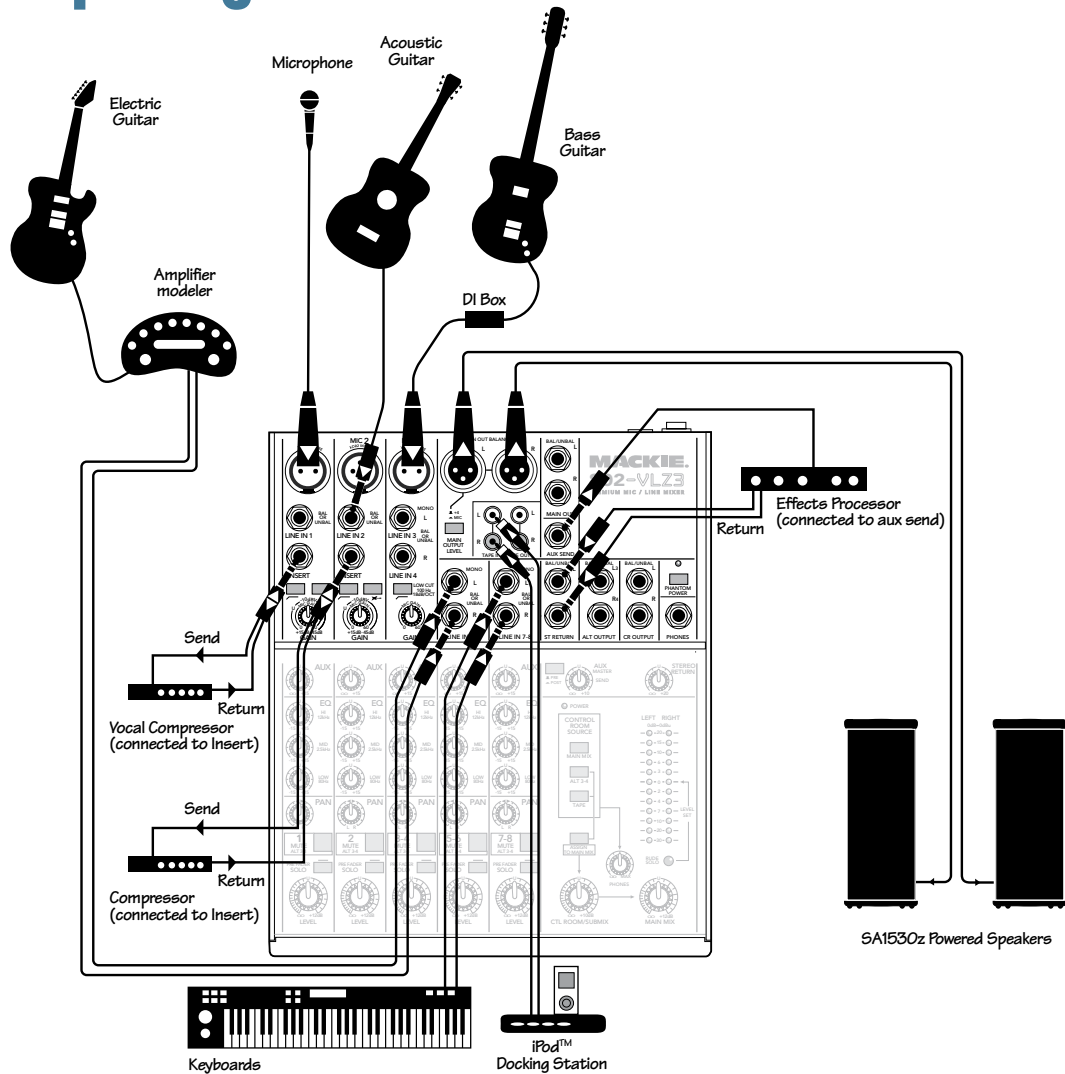

This diagram shows a microphone connected to the mic input of channel 1, and a vocal compressor connected to the insert jack. A guitar is attached to the instrument input of channel 2, with the instrument switch pressed in, and a compressor on the insert. A bass guitar is connected to channel 3's mic input via a DI box, and another guitar plays through an amplifier modeler into channels 5 and 6. Keyboards are connected to the line inputs of channels 7 and 8.

An effects processor is connected to the aux send, with the aux send set to post-level. Effects are added to the main mix via the stereo return inputs, and adjusted with the stereo return level control.

To use the aux send for stage monitors instead of an effects processor, set the aux to pre-level so the monitor volume level can be adjusted independently from the main loudspeakers.

An iPod™ docking station is connected to the tape RCA inputs, so you can play pre-recorded music during the breaks.

The main mix output connects to a pair of SA1530z powered loudspeakers to please your audience.

## Live Band PA System

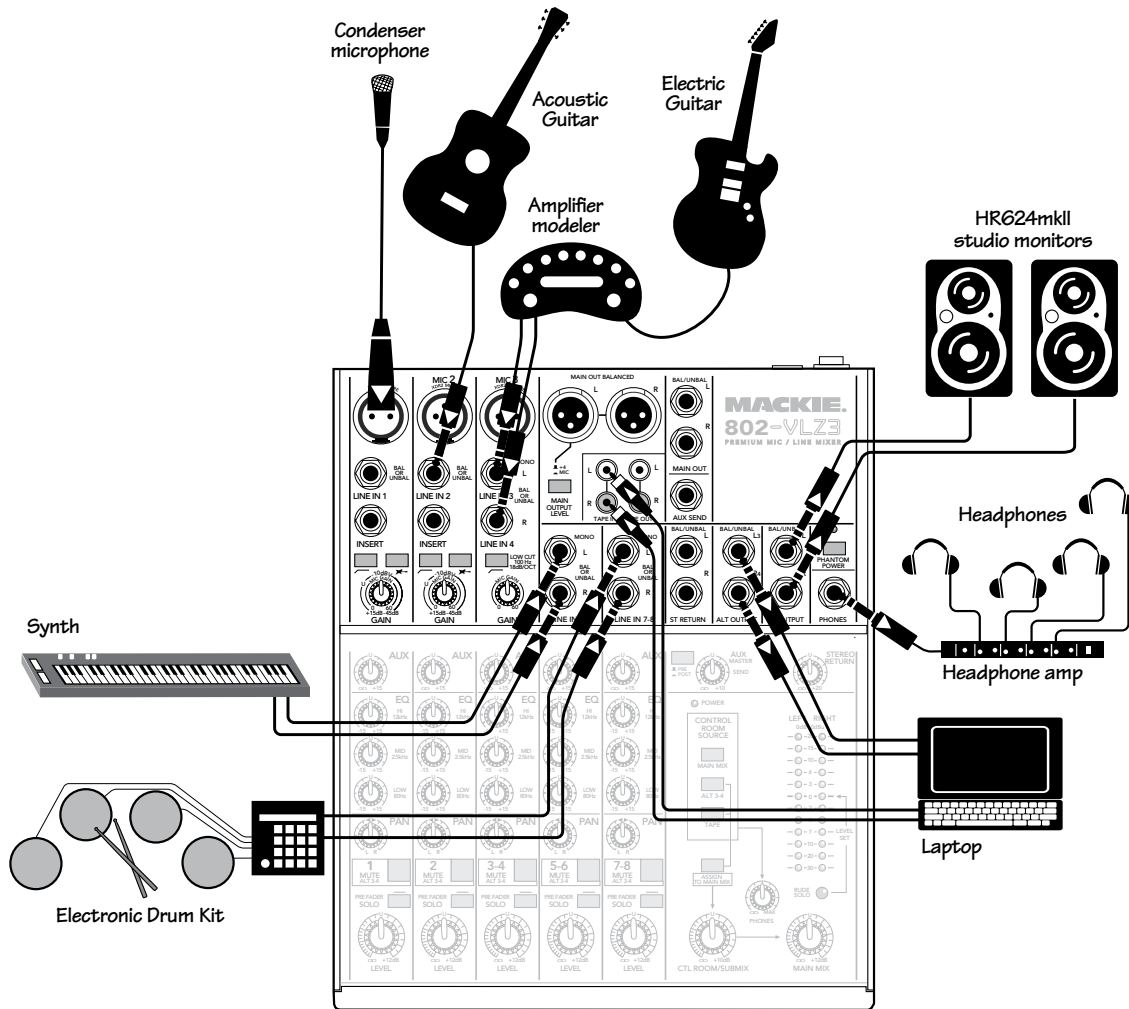

This diagram shows a condenser microphone connected to the mic input of channel 1, with phantom power engaged. A guitar is attached to the instrument input of channel 2, with the instrument switch pressed in. Another guitar plays through an amplifier modeler into channels 3 and 4. A stereo synth is connected to the line inputs of channels 5 and 6, and an electronic drum kit feeds channels 7 and 8.

The audio outputs from a laptop computer are connected to the RCA tape inputs. This allows you to playback your recordings made using the supplied Traktion software. The Alt 3-4 outputs are used to feed the inputs to your computer's sound card. By pressing a mute/alt 3-4 switch, it is easy to set up a channel to record onto your computer.

A headphone amplifier is connected to the headphones output, and feeds four pairs of headphones.

A pair of HR624mkII powered studio monitors are connected to the control room outputs.

You can use this setup to record overdub style:

1. For the track being recorded, route it to the alt 3-4 output, which feeds the computer input.
2. Monitor just the previously-recorded tracks through the tape input, which will feed the control room/phones.
3. Since only the currently-recorded track is feeding the computer (through alt 3-4), you will hear the previous tracks you are overdubbing to, but they will not be recorded to each new track.
4. The control room/phones is fed by a mixture of alt 3-4 (currently recorded track) and tape in (output of Traktion playing back previously-recorded tracks).

## Home Studio

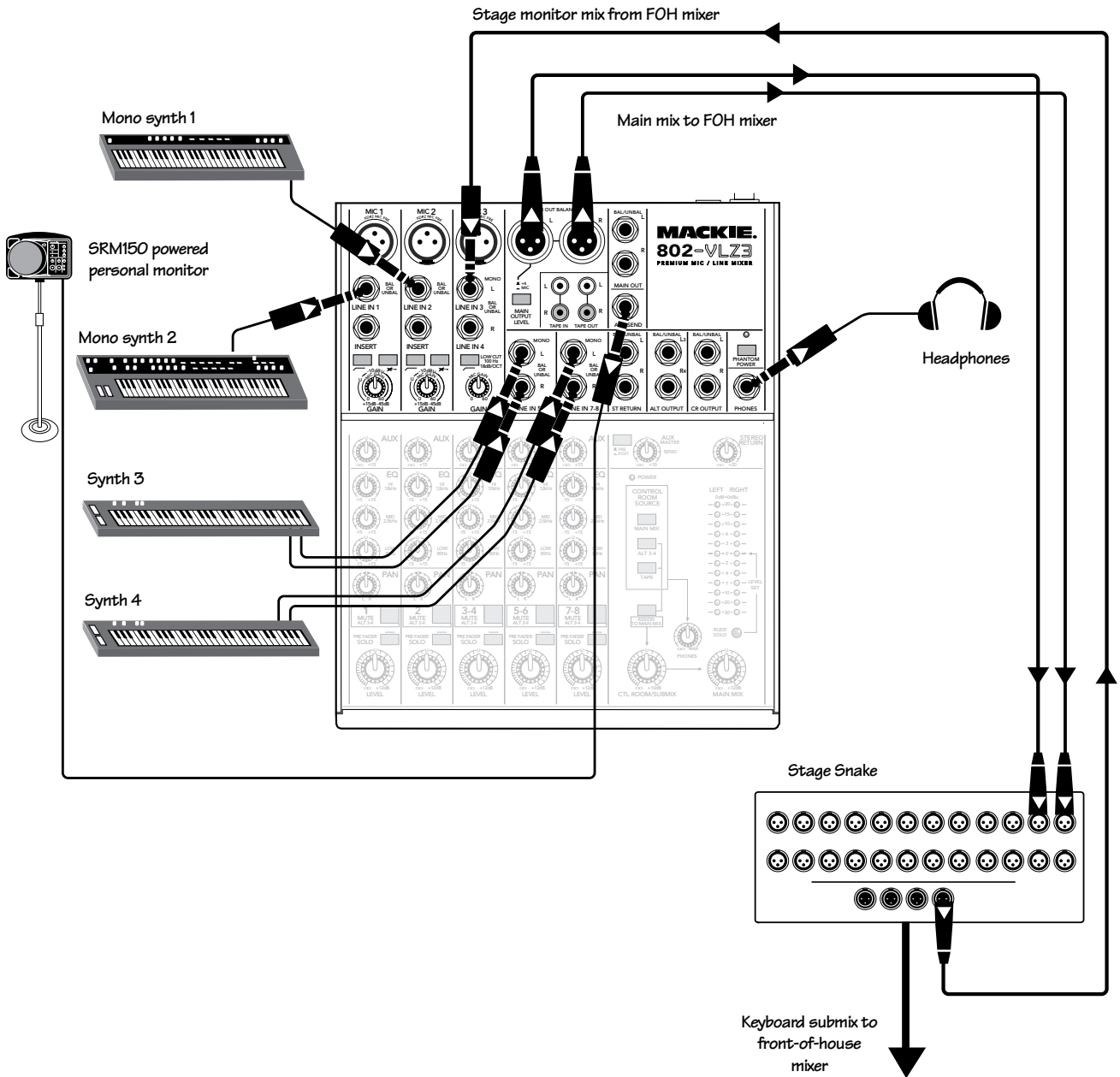

This diagram shows mono synths connected to the mono line inputs of channel 1 and 2, and stereo synths connected to the stereo line inputs of channels 5/6, and 7/8.

The XLR main mix outputs are connected to two channels of a stage snake. The main output level switch next to the main outputs is set to mic, and these balanced outputs are then suitable for sending over long cable runs from the snake to the front of house mixer. Here, the keyboard submix is added to main mix with the other instruments and vocals of your legendary all-star band.

The snake returns a stage monitor feed from the FOH mixer into channel 3's line input. Leave the channel 3 level down, so this feed is not sent to the main mix of the 802-VLZ3. Adjust the channel 3 aux control to add the stage monitor mix from the front of house mixer. Adjust the other channel's aux controls until you are happy with the overall monitor mix of your keyboards and the band's guitars/drums/vocals etc. Set the aux post/pre switch to pre-level to run the SRM150 as a powered stage monitor. With this arrangement, you have more control over what you hear in the monitor. You can add "more me" and "less them," and generally adjust the monitor mix to your liking.

A pair of headphone is connected to the headphones output.

## Keyboard Submixer



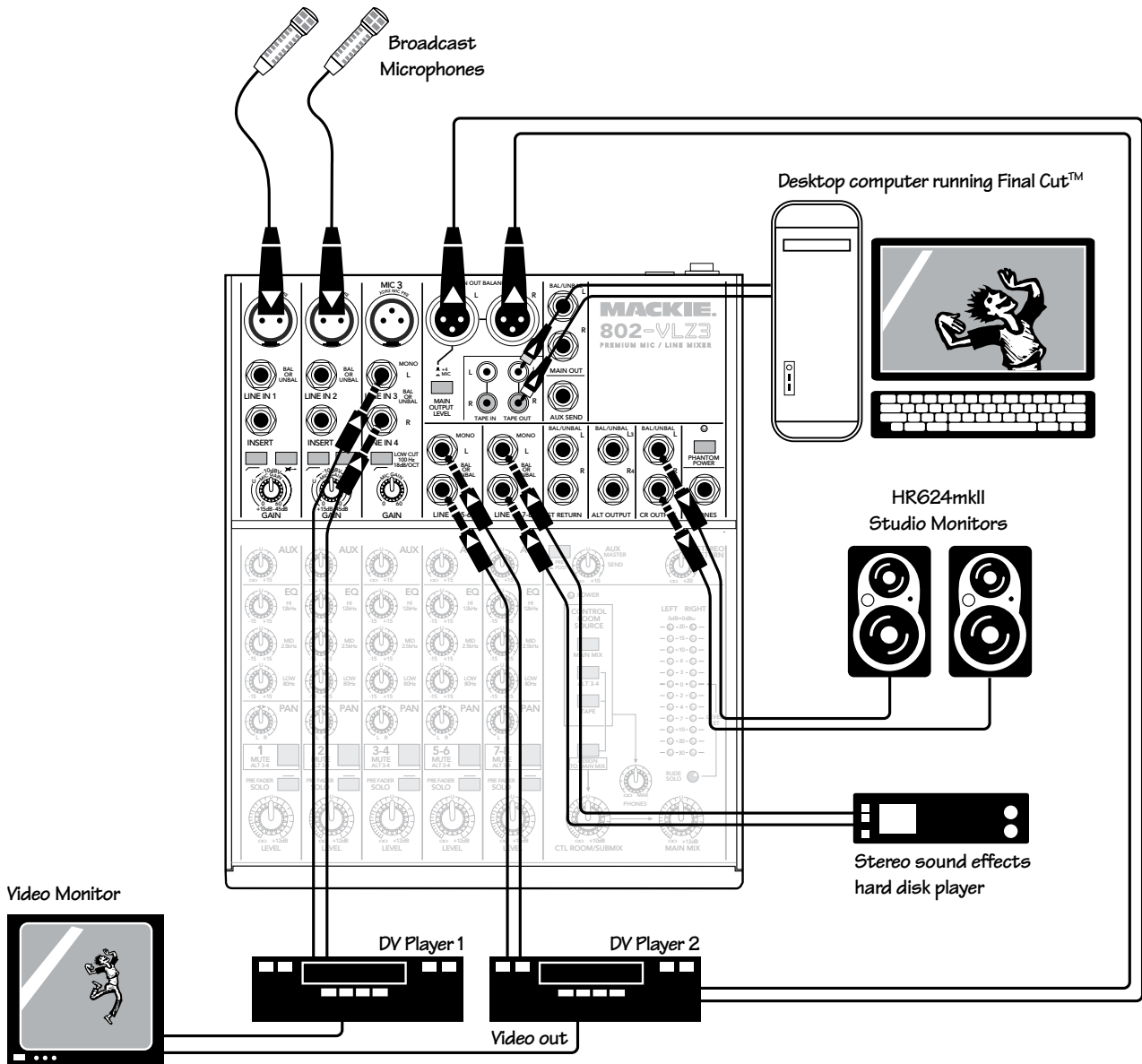

This diagram shows two voice-over microphones connected to the mic inputs of channels 1 and 2. The stereo line-level outputs from two digital video players connect to the line inputs of channels 3/4, and 5/6.

A stereo sound effects hard disk player is connected to the line inputs of channels 7 and 8.

The tape outputs connect to the line-level audio inputs of a desktop computer running Final Cut™ software. You will probably need a dual RCA to 1/8" adapter, or cable to connect to your computer's audio input.

The control room outputs feed a pair of HR624mkII powered studio reference monitors. The main mix outputs are feeding the balanced audio inputs of a video recorder.

## Video Editing/Production Bay

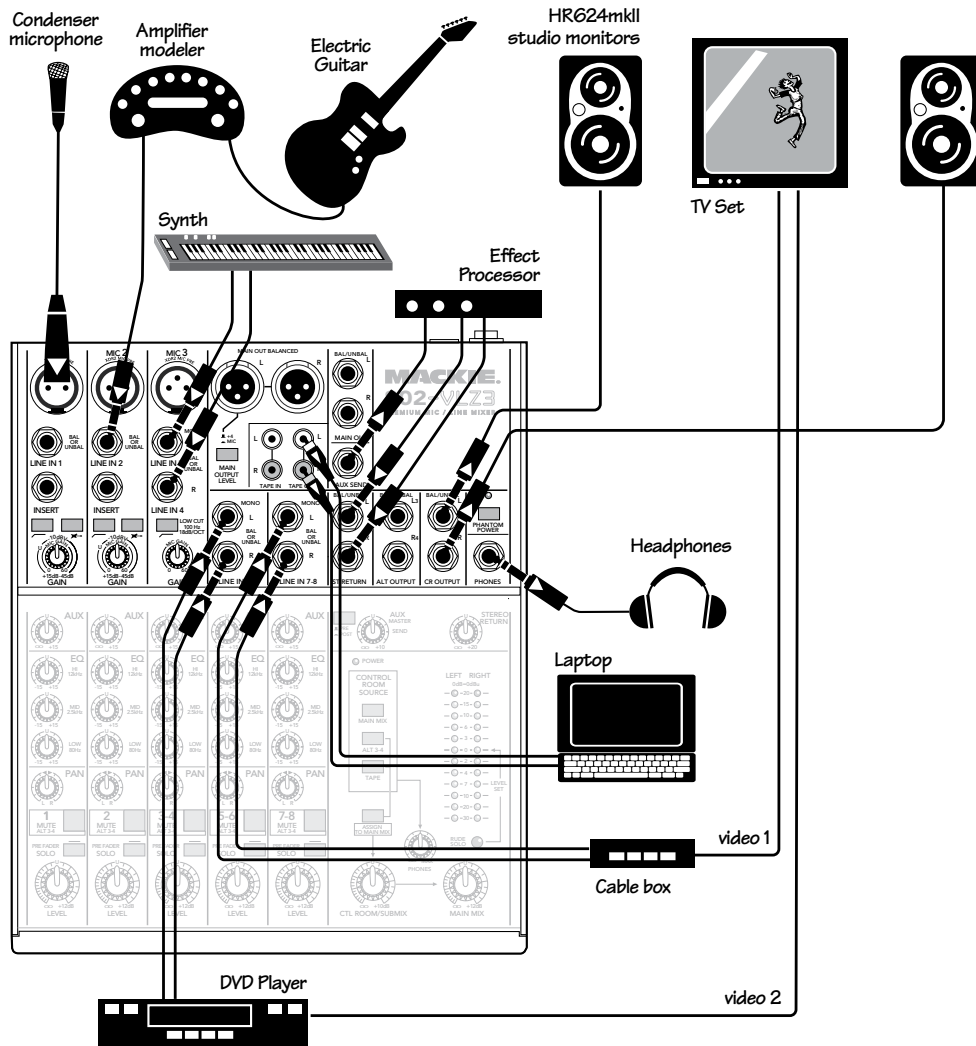

*This system is useful if you are short on space, or you are in love with a really nice pair of loudspeakers and want to share them in a home theater and home studio.*

*A condenser microphone is connected to the mic input of channel 1, with phantom power engaged. The line-level output from a guitar amplifier modeler feeds the line input of channel 2. A stereo synth is connected to channels 3 and 4. A laptop computer running Traktion is connected to the tape output, so you can record channels 1, 2, 3, and 4.*

*The stereo line-level audio output from a DVD player is connected to channels 5 and 6, and a cable box's audio output is connected to channels 7 and 8. The video output from the cable box and DVD player connect directly to the TV monitor.*

*An external effects processor is connected to the aux send (in post mode) and its output connects to the 802-VLZ3 stereo return inputs.*

*A pair of HR624mkII powered studio monitors is connected to the control room outputs. A pair of headphones is connected to the headphones output.*

*To use the home studio, sing and play your guitar, and record using Traktion, or listen through the nice speakers and headphones. Turn down channel 5-6 and 7-8 levels if you are not using the home theater.*

*To use the home theater, turn down channel 1-4's level knobs. Select a program using the cable box, and set the channel 7-8 level knob to unity. Use the control room knob to adjust the level in your loudspeakers. If you play a DVD, turn up the channel 5-6 level control to unity. Use the TV to select which video source you want to see.*

## Combined Home Studio and Home Theater

# Patchbay Description

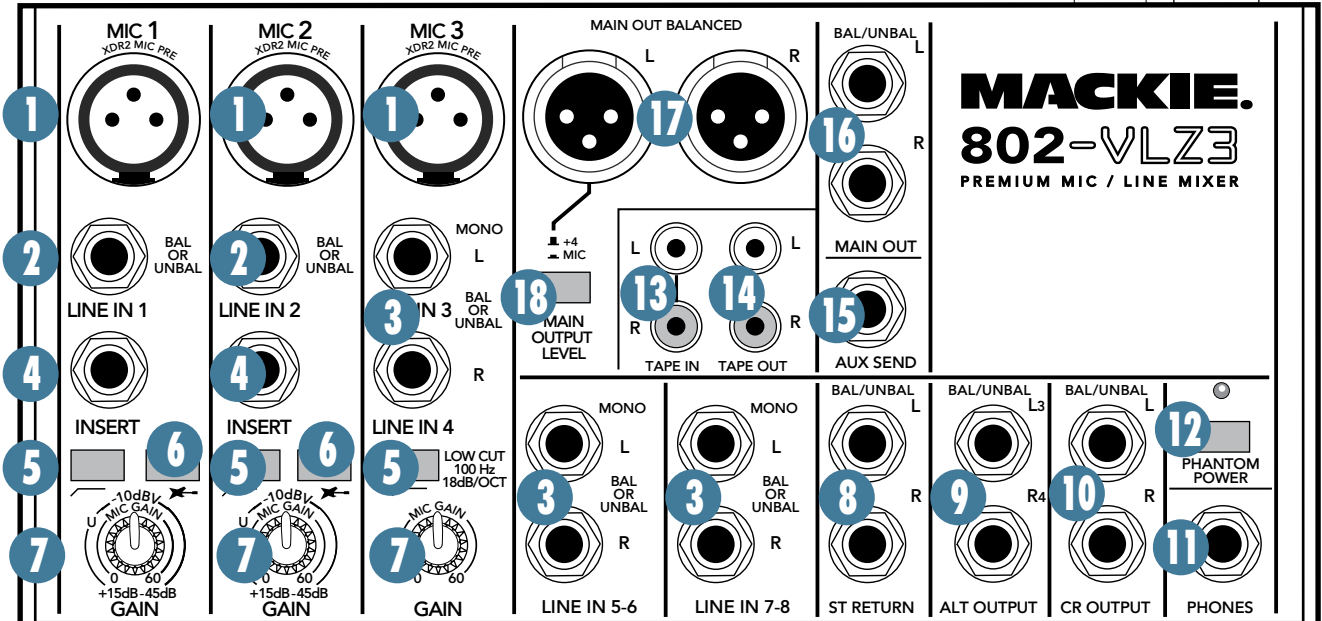

This is where you plug everything in: microphones, line-level instruments and effects, headphones, and the ultimate destination for your sound: a recorder, PA system, etc.

Appendix B has details and drawings of the connectors you can use with the 802-VLZ3. Also see the channel strip description on page 16 for details of the signal routing from the XLR and line inputs.

## 1. MIC INPUTS (Channels 1–3)

We use phantom-powered, balanced microphone inputs just like the big studio mega-consoles, for exactly the same reason: This kind of circuit is excellent at rejecting hum and noise. You can plug in almost any kind of mic that has a standard XLR male mic connector.

Professional ribbon, dynamic, and condenser mics will all sound excellent through these inputs. The 802-VLZ3's mic inputs will handle any kind of mic level you can toss at them, without overloading. Be sure to perform the level-setting procedure on page 3.

Channel 3-4 is a hybrid design, with a mono mic input in a stereo channel. The mono mic input is fed to both sides of the stereo field.



Not every instrument is made to connect directly to a mixer. Guitars commonly need a Direct Injection (DI) box to connect to the mixer's mic inputs. Channels 1 and 2 have an instrument switch [6] so you do not need a DI box, and can plug your guitar directly into the line inputs [2].

## PHANTOM POWER

Most modern professional condenser mics are equipped for phantom power, which lets the mixer send low-current DC voltage to the mic's electronics through the same wires that carry audio. (Semi-pro condenser mics often have batteries to accomplish the same thing.) “Phantom” owes its name to an ability to be “unseen” by dynamic mics (Shure SM57/SM58, for instance), which don't need external power and aren't affected by it anyway.

The 802-VLZ3's phantom power is globally controlled by the phantom power [12] switch. (This means the phantom power for the mic inputs of channels 1-3 is turned on and off together.)



Never plug single-ended (unbalanced) microphones or instruments into the mic [1] input jacks if the phantom power is on.



Do not plug instrument outputs into the mic input jacks with phantom power on, unless you know for certain it is safe to do so.



Do not use phantom power with ribbon microphones.

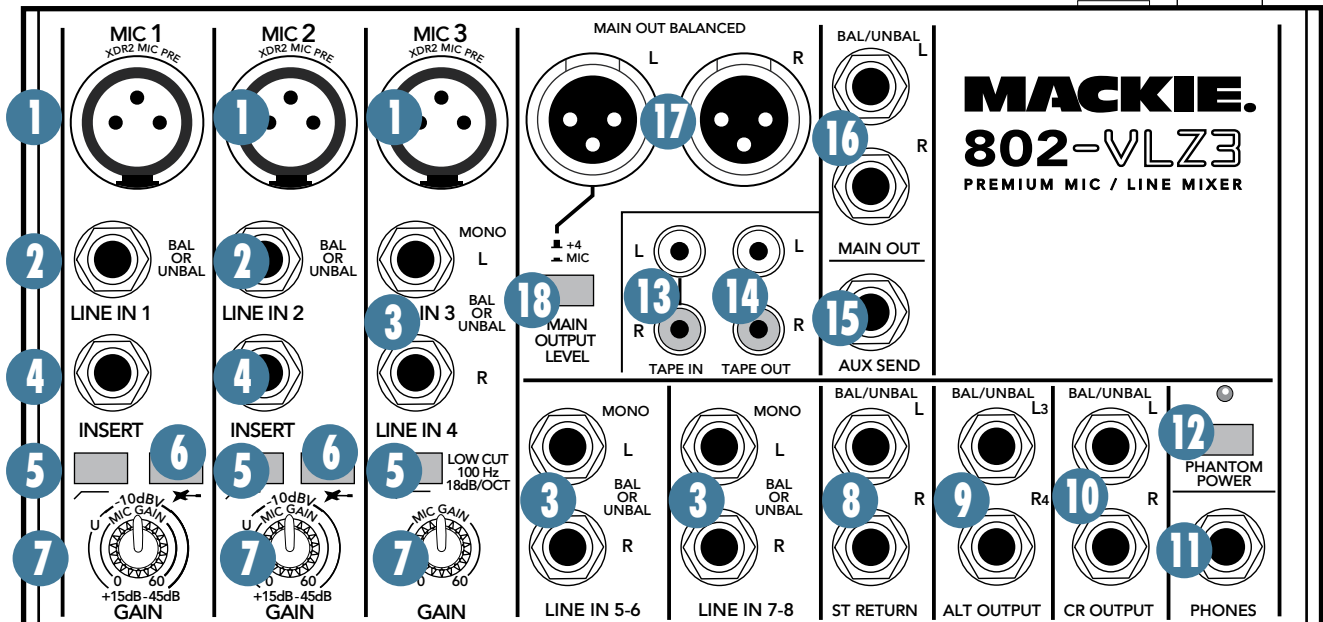

## 2. LINE INPUTS (Channels 1–2)

These inputs share circuitry (but not phantom power) with the mic preamps, and can be driven by balanced or unbalanced sources at almost any level. You can use these inputs for virtually any signal you'll come across, from instrument levels as low as  $-40$  dB to operating levels of  $-10$  dBV to  $+4$  dBu, since there is more gain available than on line inputs 3–8.

To connect balanced lines to these inputs, use a  $1/4$ " Tip-Ring-Sleeve (TRS) plug, the type found on stereo headphones.

To connect unbalanced lines to these inputs, use a  $1/4$ " mono (TS) phone plug or standard instrument cable.

The line inputs 1–2 are a good place to connect older instruments that need more gain. You can correct weak levels by adjusting the corresponding channel's gain control.

## 3. STEREO LINE INPUTS (Channels 3–4, 5–6, and 7–8)

These fully-balanced inputs are designed for stereo or mono, balanced or unbalanced signals. They can be used with just about any professional or semi-pro instrument, effect or tape player.

In the stereo audio world, an odd-numbered channel usually receives the “left signal.” For example, you would feed the 802-VLZ3's line inputs 5-6 a stereo signal by inserting the device's left output plug into the channel 5 jack, and its right output plug into the channel 6 jack.

When connecting a mono device (just one cord), always use the left (mono) input (jacks 3, 5, or 7) and

plug nothing into the right input (jacks 4, 6, or 8)—this way the signal will appear on both sides. This trick is called “jack normalizing.”

## 4. CHANNEL INSERT (Channels 1–2)

These jacks are where you connect serial effects such as compressors, equalizers, de-essers, or filters. Since most people don't have more than a few of these gadgets, we've included inserts for just the first two channels. If you want to use this kind of processing on channels 3 through 8, simply patch your source through your processor before you plug into the 802-VLZ3.

The channel insert points are after the gain [7] and low cut [5] controls, but before the channel's EQ [25–27] and level [21] controls. The send (tip) is low-impedance (120 ohms), capable of driving any line-level device. The return (ring) is high-impedance (over 2.5 k ohms) and can be driven by almost any device.

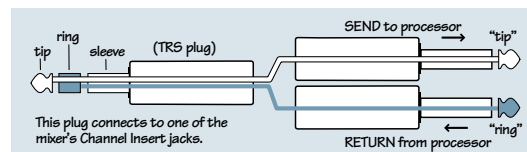

See Appendix B for details and drawings about Insert cables, and a diagram showing three ways to use the jacks.

Besides being used for inserting external devices, these jacks can also be used as channel direct outputs; post-gain, post-low cut, and pre EQ. In fact, Mackie mic preamps have become so famous, that people buy the mixers just to have some of these preamps in their arsenal.

## 5. LOW CUT (Channels 1–3)

Each low-cut switch, often referred to as a high-pass filter (all depends on how you look at it), cuts bass frequencies below 100 Hz at a rate of 18 dB per octave.

We recommend that you use low-cut on every microphone application except kick drum, bass guitar, bassy synth patches, or recordings of earthquakes. These aside, there isn't much down there that you want to hear, and filtering it out makes the low stuff you do want much more crisp and tasty. Not only that, but low-cut can help reduce the possibility of feedback in live situations, and it helps to conserve amplifier power.

Another way to consider low-cut's function is that it actually adds flexibility during live performances. With the addition of low-cut, you can safely use low equalization on vocals. Many times, bass shelving EQ can really benefit voices. Trouble is, adding low EQ also boosts stage rumble, mic handling clunks and breath pops. Applying low-cut removes all those problems, so you can add low EQ without losing a woofer.

## 6. INSTRUMENT SWITCH (Channels 1–2)

Press these in if you want to connect a guitar or other instrument-level source directly to the line inputs of channels 1 and 2. You will not need a DI box, and your guitar will perform flawlessly (well, as long as your playing is that way).

## 7. GAIN (Channels 1–3)

If you haven't already, please read the level-setting procedure on page 3.

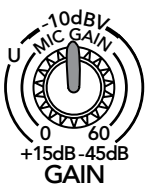

The gain knobs for channels 1 and 2 adjust the input sensitivity of the mic and line inputs. This allows signals from the outside world to be adjusted to optimal internal operating levels. The gain control for channel 3 just affects the channel 3 mic input only.

If the signal originates through the XLR jack, there will be 0 dB of gain with the knob fully down, ramping to 60 dB of gain fully up.

Through the 1/4" input (ch 1 and 2 only), there is 15 dB of attenuation fully down and 45 dB of gain fully up, with a "U" (unity gain) mark at 10:00. This 15 dB of attenuation can be very handy when you are inserting a very hot signal, or when you want to add a lot of EQ gain, or both. Without this "virtual pad," this scenario might lead to channel clipping.

## EFFECTS: SERIAL OR PARALLEL?

The next sections toss the terms "serial" and "parallel" around like hacky sacks. Here's what we mean by them:

"Serial" means that the entire signal is routed through the effects device. Examples: compressor/limiters, graphic equalizers. Line-level sources can be patched through a serial effects device before or after the mixer, or preferably through the insert jacks [4].

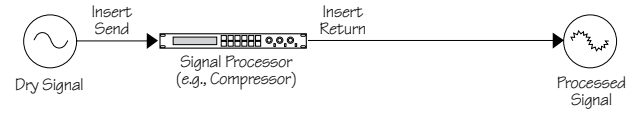

"Parallel" means that a portion of the signal in the mixer is tapped off to the device (aux send), processed and returned to the mixer (stereo return) to be mixed with the original "dry" signal. This way, multiple channels can all make use of the same effects device. Examples: reverb, digital delay.

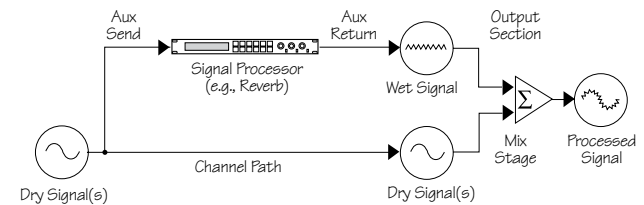

## 8. STEREO RETURN

This is where you connect the outputs of your parallel effects devices. They can also be used as an extra pair of stereo line inputs if you have a lot of synths for example. These balanced inputs are similar to the stereo line in [3] inputs (only without EQ, aux sends, pan, mute, and solo). The circuits will handle stereo or mono, balanced or unbalanced signals. They can be used with just about any pro or semipro effects device on the market. The signals coming into these inputs can be adjusted using the stereo return [38] knob before passing onto the main mix bus (see page 21 for more details).

If you have an effects device with a mono output (one cord), plug that into stereo return, left/mono, and leave stereo return, right, unplugged. This way the signal will be sent to both sides, magically appearing in the center as a mono signal.

## 9. ALT 3–4 OUTPUT

These 1/4" outputs are the sum of any channels that have the mute/alt 3-4 [23] switch pressed in (see page 16 for the tender details). The outputs are TRS 1/4" and can be connected to balanced or unbalanced lines.

For example, you can use these to feed a recorder, and just record individual channels by pressing their mute/alt 3-4 switches one at a time.

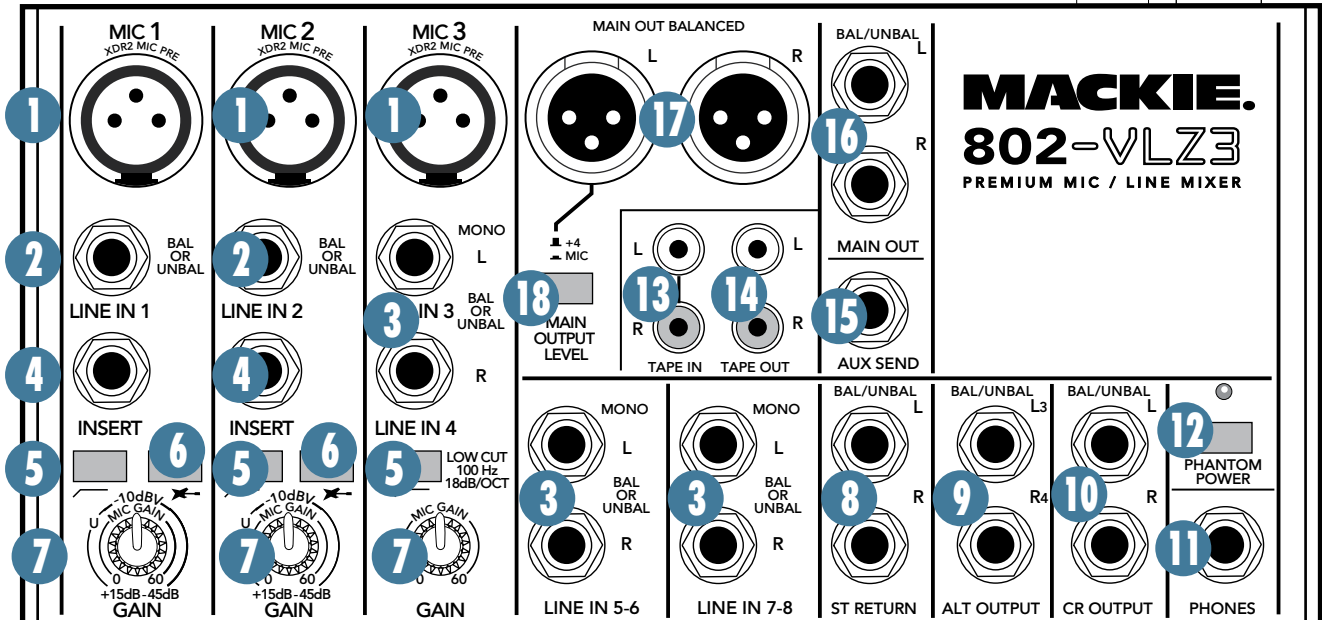

## 10. CONTROL ROOM OUTPUTS

These TRS 1/4" balanced/unbalanced outputs allow you to listen to something other than the main mix. These outputs are often used to run a nice pair of powered studio monitors in a control room. The source is selected using the source matrix [30] switches (see page 19). You can choose to listen to the main mix, the alt 3-4 stereo bus (see mute/alt 3-4 on page 16), soloed channels, or the tape input. The volume is adjustable with the control room/submix [32] knob.

## 11. PHONES

This stereo jack will drive any standard headphone to very loud levels. "iPod"-type and computer headphones can also be used here, with a 1/4" male to 1/8" female stereo adapter.

To learn how signals are routed to these outputs, see source matrix [30] on page 19. The level is adjusted with the phones knob [31], and the source is whatever the control room output is playing, such as the main mix, the alt 3-4 stereo bus, soloed channels, or the tape input. If you're wiring your own cable for the phones output, follow standard conventions:

Tip = Left channel

Ring = Right channel

Sleeve = Common ground

 **WARNING:** The headphone amp is loud, and can cause permanent ear damage. Even intermediate levels may be painfully loud with some earphones. **BE CAREFUL!** Always turn the phones [31] knob all the way down before connecting headphones. Keep it down until you've put the phones on. Then turn it up slowly.

## 12. PHANTOM SWITCH and LED

This global switch controls the phantom power supply for condenser microphones plugged into the mic [1] inputs. See the phantom power details on page 11 before using this switch.

Press the switch in to engage phantom power to the three mic inputs. Press the switch out to turn it off. The LED will come on when phantom power is engaged.



Phantom power is supplied to all three mic inputs at once, therefore, do not use a ribbon microphone in any of these inputs when phantom power is engaged.

## 13. TAPE INPUT

Connect your computer audio outputs, or tape recorder's outputs here, using standard hi-fi (RCA) cables.

Use these jacks for convenient tape playback of your mixes. You'll be able to review a mix and then rewind and try another pass without repatching or disturbing the mixer levels. You can also use these jacks with a portable tape or CD player to feed music to a PA system between sets.



**WARNING:** engaging both the tape and assign to main mix buttons in the control room source [30] matrix can create a feedback path between tape input and tape output. Make sure your tape deck is not in record, record-pause, or input monitor mode, when you engage these switches, or make sure the control room / submix [32] level knob is fully counterclockwise (off).

## 14. TAPE OUTPUT

These unbalanced RCA connections tap the main mix output to make simultaneous recording and PA work more convenient. Connect these to your recorder's inputs. (See also main mix [29] on page 19.)

**Mono Out:** If you want to feed a mono signal to your tape deck or other device, simply use an RCA Y-cord to combine these outputs. Do not attempt this with any other outputs on the 802-VLZ3.

## 15. AUX SEND

This is a TRS 1/4" balanced/unbalanced output, commonly used to feed stage monitors (with aux set to pre) or an external effects processor (with aux set to post).

The aux send [28] knobs tap a portion of each channel's signal to provide an output here, allowing you to set up a nice stage monitor mix, or to set up an external effect from different channels. See the aux send details on page 18.

## 16. 1/4" MAIN OUTS

These 1/4" TRS balanced/unbalanced outputs feed the main mix out into the waiting world. You can feed your amplifiers or powered speakers this way, or through the XLR main outs [17].

To use these outputs to drive balanced inputs, connect 1/4" TRS (Tip–Ring–Sleeve) phone plugs like this:

Tip = + (hot)  
 Ring = –(cold)  
 Sleeve = Ground

For most music recording and PA applications, unbalanced lines are fine. To drive unbalanced inputs, connect 1/4" TS (Tip–Sleeve) phone plugs like this:

Tip = + (hot)  
 Sleeve = Ground

## 17. XLR MAIN OUTS

Use these to send the main mix out into the line-level balanced inputs of your amplifier or powered speakers.

These low-impedance outputs are fully balanced, and this output is 6 dB hotter than other outputs.

## 18. XLR MAIN OUTPUT LEVEL SWITCH

Engaging this switch reduces the level of the balanced XLR main outputs, so you can feed the microphone input of, say, another mixer. (You can safely connect the XLR outputs into an input that provides 48V phantom power.)

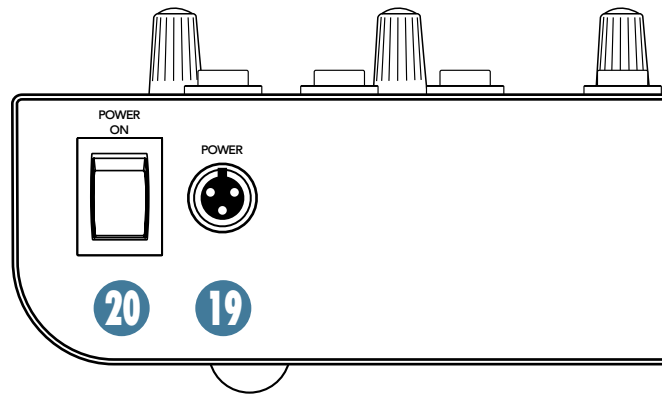

## 19. POWER CONNECTION

This is where you plug in the connector from the AC adapter supplied with your mixer.



Only use the AC adapter that came with your mixer, or a factory-authorized power supply.

## 20. POWER SWITCH

Press the top of this rocker switch inwards to turn on the mixer. The power LED [39] on the top surface of the mixer will glow with happiness, or at least it will if you have the mixer plugged in to a suitable live AC mains supply.

Press the bottom of this switch to turn off the mixer, whenever you feel that this would be a safe thing to do.

As a general guide, you should turn on your mixer first, before the power amplifier or powered speakers, and turn it off last. This will reduce the possibilities of any turn-on, or turn-off thumps in your speakers.

# Channel Strip Description

The five channel strips look alike, and function identically. The first two are for individual mics or mono instruments, and have more gain available. The next strip controls mic or stereo line-level sources, and the last two are for either stereo or mono line-level sources. (Each of the stereo channel strips is actually two complete circuits. The controls are linked together to preserve stereo.) We'll start at the bottom and work our way up:

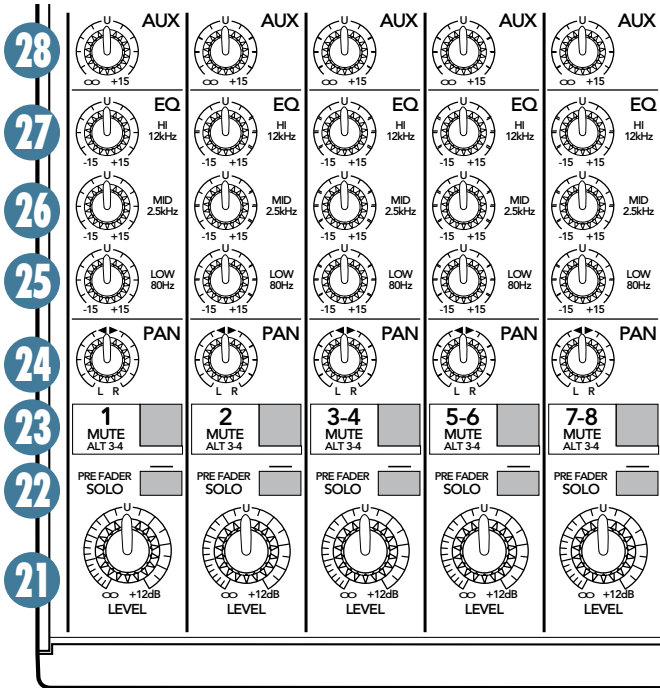

## “U” LIKE UNITY GAIN

Mackie mixers have a “U” symbol on almost every level control. This “U” stands for “unity gain,” meaning no change in signal level. Once you have adjusted the input signal to line-level, you can set every control at “U” and your signals will travel through the mixer at optimal levels. What’s more, all the labels on our level controls are measured in decibels (dB), so you’ll know what you’re doing level-wise if you choose to change a control’s settings.

## 21. LEVEL

This adjusts the channel’s level, from off, to unity gain at the center, on up to 12 dB of additional gain.

The knob is the equivalent of a channel fader, so sometimes we lapse and say the word fader.

## 22. PRE-FADER SOLO

This lovable switch allows you to hear signals through your headphones or control room without having to

route them to the main mix or alt 3-4 mix. You don’t even have to have the channel’s level [21] knob turned up. Folks use solo in live work to preview channels before they are let into the mix, or to just check out what a particular channel is up to anytime during a session. You can solo as many channels at a time as you like.

Solo is also the key player in the Level-Setting Procedure on page 3.

Soloed channels are sent to the source mix, which ultimately feeds your control room, phones and meter display. Whenever solo is engaged, all source selections (main mix, alt 3-4 and tape) are defeated, to allow the soloed signal to do just that — solo!



**WARNING:** Pre-fader solo taps the channel signal before the level knob. If you have a channel’s level knob set below “U” (unity gain), solo won’t know that and will send a unity gain signal to the control room, phones and meter display. That may result in a startling level boost at these outputs.

## 23. MUTE/ALT 3-4

The dual-purpose mute/alt 3-4 bus is a Mackie signature. When Greg was designing our first product, he had to include a mute switch for each channel. Mute switches do just what they sound like they do. They turn off the signal by “routing” it into oblivion. “Gee, what a waste,” Greg reasoned. “Why not have the mute button route the signal somewhere else useful... like a separate stereo bus?” So mute/alt 3-4 really serves two functions — muting (often used during a mixdown or live show), and signal routing (for multitrack and live work) where it acts as an extra stereo bus.

To use this as a mute switch, all you have to do is not use the alt 3-4 [9] outputs. Then, whenever you press this switch, you will assign a channel to these unused outputs, disconnecting it from the main mix, and effectively muting the channel.

To use this as an alt 3-4 switch, all you have to do is connect the alt 3-4 outputs to whatever destination you desire. Here are two popular examples:

When doing multitrack recording, use the alt 3-4 outputs to feed your multitrack. With most decks, you can “mult” the alt 3-4 [9] outputs, using Y-cords or mults, to feed multiple tracks. So, take alt output L and send it to tracks 1, 3, 5 and 7, and alt output R and send it to tracks 2, 4, 6 and 8. Now, tracks that are in record or input modes will hear the alt 3-4 signals, and tracks in playback or safe modes will ignore them.



When doing live sound or mixdown, it's often handy to control the level of several channels with one knob. That's called subgrouping. Simply assign these channels to the alt 3–4 mix, engage alt 3–4 in the source [30] matrix, and the signals will appear at the control room [10] and phones [11] outputs. If you want the alt 3–4 signals to go back into the main mix, engage the assign to main mix [33] switch, and the control room/submix [32] level control becomes the one knob to control the levels of all the channels assigned to alt 3–4.

Another way to do the same thing is assign the channels to the alt 3–4 mix, then patch out of the alt 3–4 output [9] back into an unused stereo channel line input [3]. If that's your choice, don't ever engage the mute/alt 3–4 switch on that stereo channel, or you'll have every dog in the neighborhood howling at your feedback loop.

Another benefit of the alt 3–4 feature is that it can act as a “sip” (solo-in-place): just engage a channel's mute/alt 3–4 switch and the alt 3–4 switch in the source matrix and you'll get that channel, all by itself, in the control room and phones.

Mute/alt 3–4 is one of those controls that can bewilder newcomers, so take your time and play around with it. Once you've got it down, you'll probably think of a hundred uses for it!

## 24. PAN

Pan adjusts the amount of channel signal sent to the left versus the right outputs. On mono channels (ch. 1–3 or 3–8, with connections to the left input only) these controls act as pan pots. On stereo channels (3–8) with stereo connections to left and right inputs, the pan knob works like the balance control on your home stereo.

Pan determines the fate of the main mix and alt 3–4 mix. With the pan knob hard left, the signal will feed either main out left or alt output left, depending on the position of the alt 3–4 switch [23]. With the knob hard right, the signal feeds main out right or alt output right.

## CONSTANT LOUDNESS !!!

The 802-VLZ3's pan controls employ a design called “Constant Loudness.” It has nothing to do with living next to an all-night disco. As you turn the pan [24] knob from left to right (thereby causing the sound to move from the left to the center to the right), the sound will appear to remain at the same volume (or loudness).

If you have a channel panned hard left (or right) and reading 0 dB, it must dip down about 4 dB on the left (or right) when panned center. To do otherwise (the way brand X compact mixers do) would make the sound appear much louder when panned center.

## 3-BAND EQ

The 802-VLZ3 has 3-band equalization at carefully selected points — low shelving at 80 Hz, mid peaking at 2.5 kHz, and high shelving at 12 kHz. “Shelving” means that the circuitry boosts or cuts all frequencies before or past the specified frequency. For example, rotating the low EQ knob 15 dB to the right will boost the bass at 80 Hz and lower, down to the lowest note you never heard. “Peaking” means that certain frequencies form a “hill” around the center frequency — 2.5 kHz in the case of the mid EQ.

## 25. LOW EQ

This control gives you up to 15 dB boost or cut below 80 Hz. The circuit is flat (no boost or cut) at the center detent position. This frequency represents the punch in bass drums, bass guitar, fat synth patches, and some really serious male singers.

Used in conjunction with the low cut [5] switch, you can boost the low EQ without injecting a ton of subsonic debris into the mix.

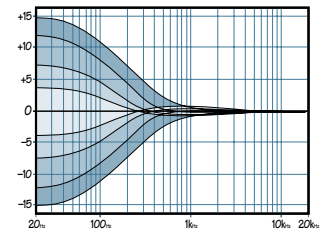

*Low EQ*

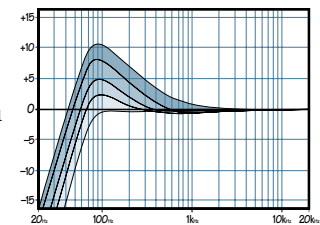

*Low EQ with Low Cut*

## 26. MID EQ

Short for “midrange,” this knob provides 15 dB of boost or cut, centered at 2.5 kHz, also flat at the center detent. Midrange EQ is often thought of as the most dynamic, because the frequencies that define any particular sound are almost always found in this range. You can create many interesting and useful EQ changes by turning this knob down as well as up.

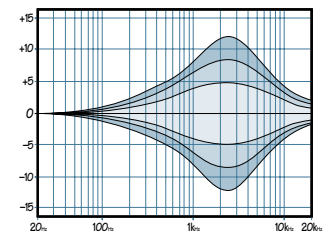

*Mid EQ*

## 27. HI EQ

This control gives you up to 15 dB boost or cut above 12 kHz, and it is also flat at the detent. Use it to add sizzle to cymbals, and an overall sense of transparency, or edge to keyboards, vocals, guitar and bacon frying. Turn it down a little to reduce sibilance, or to hide tape hiss.

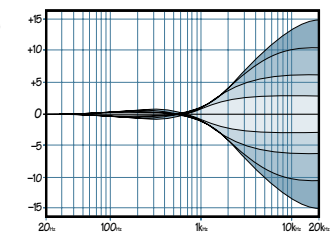

*High EQ*

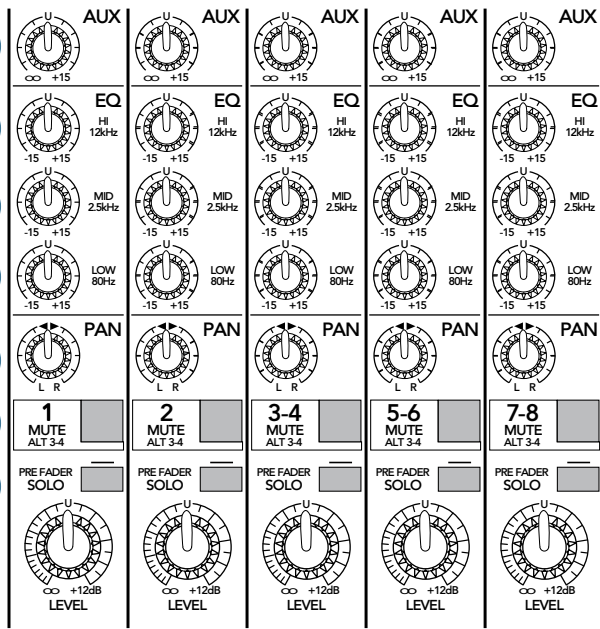

## MODERATION DURING EQ

With EQ, you can also upset things royally. We've designed a lot of boost and cut into each equalizer circuit, because we know everyone will occasionally need that. But if you max the EQs on every channel, you'll get mix mush. Equalize subtly and use the left sides of the knobs (cut), as well as the right (boost). Very few gold-record-album engineers ever use more than about 3 dB of EQ. If you need more than that, there's usually a better way to get it, such as placing a mic differently (or using a different kind of mic or singer entirely).

## 28. AUX

These knobs allow you to tap a portion of each channel signal out to another source for parallel effects processing or stage monitoring. Aux send levels are controlled by these knobs and by the aux master [37].

These are more than just effects and monitor sends. They can be used to generate separate mixes for recording or "mix-minuses" for broadcast. By using aux in the pre mode, these mix levels can be obtained independently of the channel's level control.

Aux in post mode is post-low cut, post-EQ and post-level. That is, the aux send obeys the settings of these controls. Aux in pre mode follows the EQ and low cut settings only. Pan and level have no effect on the pre send.

The aux send level ranges from off through unity (the center position) on up to 15 dB of extra gain (when turned fully clockwise). Chances are you'll never need this extra gain, but it's nice to know it's there if you do.

The channel 3–8 aux knobs control the mono sum of the channel's stereo signals for each aux send. For instance, channel 5 (L) and 6 (R) mix together to feed that channel's aux send knob.

Still with us? Good for you. Here come the tricky parts, the output or master section where the mixing is really done.

# Output Section

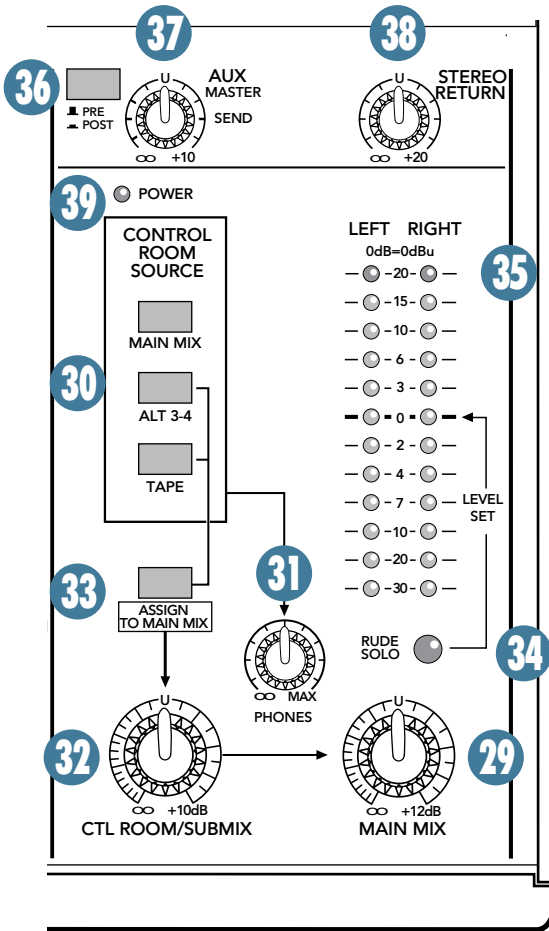

## 29. MAIN MIX

This knob controls the levels of signals sent to the main outputs: XLR [17] and 1/4" [16] and RCA tape output [14]. All channels and stereo returns [8] that are not muted or turned fully down will wind up in the main mix.

Fully counterclockwise is off, the center is unity gain, and fully clockwise provides 12 dB of additional gain. This additional gain will typically never be needed, but once again, it's nice to know it's there. This is the knob to turn down at the end of the song when you want "The Great Fade-Out."

## 30. CONTROL ROOM SOURCE MATRIX

Typically, the engineer sends the main mix to an audience (if live) or a mixdown deck (if recording). But what if the engineer in the control room needs to hear something other than the main mix? With the 802-VLZ3, the engineer has several choices of what to listen to. This is one of those tricky parts, so brace yourself.

With these source switches, you can choose to listen to any combination of main mix, alt 3-4 and tape. By now, you probably know what the main mix is. Alt 3-4 is

that additional stereo mix bus. Tape is the stereo signal coming in from the tape input [13] jacks.

Selections made in the source matrix deliver stereo signals to the control room, phones and meter display. With no switches engaged, there will be no signal at these outputs and no meter indication.

The exception is the solo function. Regardless of the source selection, engaging a channel's solo [22] switch will replace that selection with the solo signal, also sent to the control room, phones and meters. This is what makes the level-setting procedure so easy to do.



**Warning:** engaging both the tape and assign to main mix [33] button can create a feedback path between tape input [13] and tape output [14]. Make sure your tape deck is not in record, record-pause, or input-monitor mode when you engage these switches, or make sure the control room / submix [32] level knob is fully counterclockwise (off).

Now you know how to select the signals to send to the engineer's control room or phones.

## 31. PHONES

This knob controls the level going to your stereo headphones. Make sure this is fully down whenever you are making connections in your system, or putting on the headphones. Bring up the level slowly and carefully to protect your hearing.

This dedicated phones level knob makes it is easy to turn down the studio monitors and listen just with the headphones, when overdubbing, or when in a room full of sleeping and hungry leopards.

## 32. CONTROL ROOM/SUBMIX

This knob controls the level of the stereo control room outputs [10]. The control range is from off through unity gain at the center, with 10 dB of extra gain when turned fully clockwise.

When main mix is your control room source selection, those signals will now pass through three level controls on the way to your control room amp and phones : the main mix [29] knob, this control room / submix knob, and the phones knob [31]. This way, you can send a nice healthy level to the main output (main mix knob at "U"), and a quiet level to the control room or phones (control room / submix knob and phones knob where you like).

When alt 3-4 or tape is selected, or a channel solo [22] is engaged, the control room / submix knob and phones knob will be the only ones controlling these levels (channel controls notwithstanding).

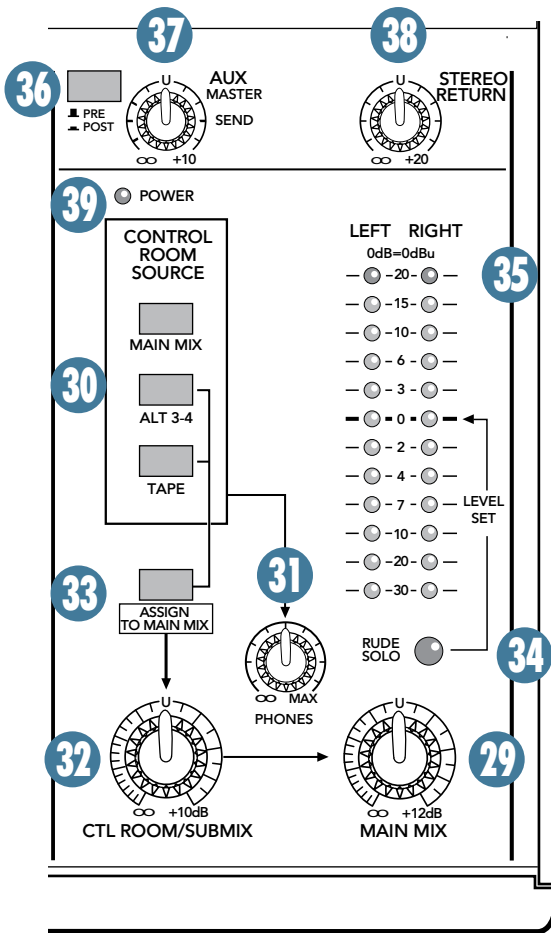

Whatever your selection, you can also use the control room [10] outputs for other applications. Its sound quality is just as impeccable as the main outs [16 and 17]. It can be used as additional main mix output, which may sound silly since there are already three, but this one has its own level control. However, should you do something like this, be sure that you do not engage a solo switch, as that will interrupt your source selection.

### A WORD ABOUT PRE-FADER SOLO (PFL)

Engaging a channel's solo [22] switch will cause this dramatic turn of events: any existing control room source selections will be replaced by the solo signal, appearing in the control room, headphones, and in the meter. The audible solo levels are then controlled by the control room / submix [32] knob and phones [31] knob. The solo levels appearing on the meter display are not controlled by anything — you wouldn't want that. You want to see the actual channel level on the meter regardless of how loud you're listening.

“Pre-fader” solo means that the channel signal is being tapped before the channel's level [21] knob. It does, however, obey gain [7], low cut [5] and EQ [25–27] settings, making it the perfect tool for quick inspections of suspect channels. The channel's pan [24] and mute/alt 3-4 [23] settings have no effect on the solo signal.

Note: for stereo channels 3-8, the solo signal is the mono sum of the left (odd-numbered) and right (even-numbered) signals for that channel strip.



**Warning:** pre-fader solo [22] taps the channel signal before the level knob. If you have a channel's level knob set below "U" solo won't know that, and will send a unity gain signal to the control room, phones and meter display, that may result in a startling level boost at these outputs.

### 33. ASSIGN TO MAIN MIX

Let's say you're doing a live show. Intermission is nearing and you'll want to play a soothing CD for the crowd to prevent them from eating the furniture. Then you think, “But I have the CD player plugged into the tape inputs, and that never gets to the main outs!” Oh, but it does. Simply engage this switch and your control room source selection, after going through the control room / submix [32] knob, will feed into the main mix, just as if it were another stereo channel.

Another handy use for this switch is to enable the alt 3-4 mix to become a submix of the main mix, using the control room/submix knob as its level control.

Side effects: (1) engaging this switch will also feed any soloed channels into the main mix, which may be the last thing you want. (2) If you have the main mix as your control room source selection and then engage assign to main mix, the main mix lines to the control room will be interrupted to prevent feedback. Then again, why would anyone want to assign the main mix to the main mix?

### 34. RUDE SOLO

If you happen to forget you're in solo, you can easily be tricked into thinking that something is wrong with your mixer. Hence the flashing rude solo light. This will come on whenever a channel solo switch [22] is engaged.

It's especially handy at about 3 a.m. when no sound is coming out of your monitors but your multitrack is playing back like mad.

### 35. METERS

The 802-VLZ3's peak metering system is made up of two columns of twelve LEDs. Deceptively simple, considering the multitude of signals that can be monitored by it.

If nothing is selected in the source matrix and no channels are in solo, the meters will just sit there and do nothing. To put them to work, you must make a selection in the source matrix [30], or engage a solo switch [22]. Why? You want the meter display to reflect what the engineer is listening to, and as we've covered, the

engineer is listening either to the control room [10] outputs or the phones [11] outputs. The only difference is that while the listening levels are controlled by the control room / submix [32] knob, the meters read the source mix before that control, giving you the real facts at all times, even if you're not listening at all.

Thanks to the 802-VLZ3's wide dynamic range, you can get a good mix with peaks flashing anywhere between -20 and +10 dB on the meters. Most amplifiers clip at about +10 dB, and some recorders aren't so forgiving either. For best real-world results, try to keep your peaks between "0" and "+6".

Remember, audio meters are just tools to help assure you that your levels are "in the ballpark." You don't have to stare at them (unless you want to).

## A word about Aux

Sends are outputs, and returns are inputs. The channel aux [28] knobs taps the signal off each channel. The sum of the aux signals is sent to the aux master [37] knob before going to the aux send [15] output.

This output can be fed to the inputs of a reverb or other device. From there, the outputs of this external device are fed back to the mixer's stereo return [8] jacks, through the stereo return [38] level control, and finally delivered to the main mix.

So, the original "dry" signals go from the channels to the main mix, and the affected "wet" signals go from the stereo return [8] to the main mix. Once mixed together, the dry and wet signals combine to create a glorious sound. So, armed with this knowledge, let's visit the auxiliary world:

## 36. PRE or POST (AUX)

Besides being used to work effects into your mix, aux sends serve another critical role — that of delivering cue mixes to stage monitors, so musicians can hear what they're doing. On the 802-VLZ3, aux send can play either role, depending on the position of this switch.

With this switch out (disengaged), aux send will tap a channel pre-fader and pre-mute/alt 3-4, meaning that no matter how you manipulate those controls as they feed the main mix, the aux send will continue to belt out that channel's signal. This is the preferred method for setting up stage monitor feeds, as its level is not affected by changes to the channel's level controls. EQ settings will affect all aux sends. It's a bit like setting up two PAs, one at a nice level to keep your band happy, and one at a nice level to play to your audience. The levels of each are independent of each other.

With the switch in, the aux send becomes an ordinary effects send — post-fader (level) and post-mute/alt

3-4. This is a must for effects sends, since you want the levels of your "wet" signals to follow the level of the "dry," keeping them at the same ratio. For example, you do not want a returned echo to stay at one level, when you turn a channel down; you want it to go down as well. Post mute/alt 3-4 means that when a channel is muted, its aux send to an external processor is also muted.

## 37. AUX MASTER SEND

This knob provides overall level control of aux send, just before it's delivered to the aux send [15] output. This knob goes from off (turned fully down), to unity gain at the center, with 10 dB of extra gain (turned fully up). You may never need the additional gain, but here it is anyway.

This is the knob to turn up when the lead singer glares at you, points at his stage monitor, and sticks his thumb up in the air. (If he stuck his thumb down, you'd turn the knob down, but that never happens.)

## 38. STEREO RETURN

This control sets the overall level of effects received from the stereo return [8] inputs. This could be the affected (wet) processed signal returning from an effects processor, or the stereo signals from another synth or source. This control is designed to handle a wide range of signal levels, from off, to unity gain at the center, with 20 dB gain fully clockwise, to compensate for low-level effects or sources.

Normally, set this knob at the center, and set the effects device or source's output control to whatever they call unity gain (check their manual). If that turns out to be too loud or too quiet, adjust the effects device or source's outputs, not the mixer. That way, the mixer's knobs are easy to relocate at the center.

Signals passing through this control proceed directly to main mix. The stereo returns do not have mute/alt 3-4 switches, so if you want these signals to get to the alt 3-4 mix, you'll have to patch the effects device's outputs into one of the stereo channels instead of the stereo return, and mute/alt those channels.

## 39. POWER LED

This LED will light when the mixer is connected to a live power supply, and the power switch is turned on. This lets you know that the mixer's internal circuits are turned on, and all ready for action.

Turning off the power switch will turn off the mixer and this LED will go out.

Congratulations! You've just read about all the features of your 802-VLZ3. You're probably ready for a cold one. Go ahead. The rest of the manual can wait.

# Appendix A: Service Information

If you think your 802-VLZ3 has a problem, please check out the following troubleshooting tips and do your best to confirm the problem. Visit the support section of our website ([www.mackie.com](http://www.mackie.com)) where you will find lots of useful information such as FAQs, documentation and user forums. You may find the answer to the problem without having to send your mixer away.

## Troubleshooting

### Bad Channel

- Is the gain set correctly?
- Is the level knob turned up?
- Is the instrument switch set correctly? (Channels 1–2 only).
- Try the same source signal in another channel, set up exactly like the suspect channel.
- Check that the pan knob is set correctly.
- Check the EQ and the low-cut switch.

### Bad Output

- Is the associated level knob (if any) turned up?
- If it's one of the main outs, try unplugging all the others. For example, if it's the 1/4" left main out, unplug the RCA and XLR left outputs. If the problem goes away, it's not the mixer.
- If a left speaker is presumed dead, switch the left and right cords, at the mixer's main outs. If the left speaker is still not working, it's not the mixer.

### Noise

- Turn the channel level and aux return knobs down, one by one. If the sound disappears, it's either that channel or whatever is plugged into it, so unplug whatever that is. If the noise disappears, it's from your whatever.

### Power

- Check that the supplied power supply is connected to a live AC outlet. The power LED on the mixer should come on when the power switch is on.

## Repair

For warranty repair or replacement, refer to the warranty information on page 27.

Non-warranty repair for Mackie products is available at a factory-authorized service center. To locate your nearest service center, visit [www.mackie.com](http://www.mackie.com), click "Support" and select "Locate a Service Center." Service for Mackie products living outside the United States can be obtained through local dealers or distributors.

If you do not have access to our website, you can call our Tech Support department at 1-800-898-3211, Monday-Friday, 7 am to 5 pm Pacific Time, to explain the problem. Tech Support will tell you where the nearest factory-authorized service center is located in your area.

### Need help with your new mixer?

- **Visit [www.mackie.com](http://www.mackie.com) and click Support to find: FAQs, manuals, addendums, and user forums.**
- **Email us at: [techmail@mackie.com](mailto:techmail@mackie.com).**
- **Telephone 1-800-898-3211 to speak with one of our splendid technical support representatives, (Monday through Friday, from 7 a.m. to 5 p.m. PST).**

# Appendix B: Connections

## "XLR" Connectors

Mackie mixers use 3-pin female "XLR" connectors on all microphone inputs, with pin 1 wired to the grounded (earthed) shield, pin 2 wired to the "high" ("hot" or positive polarity) side of the audio signal and pin 3 wired to the "low" ("cold" or negative polarity) side of the signal. See Figure A. This is all totally aboveboard and in full accord with the hallowed standards dictated by the AES (Audio Engineering Society).

Use a male "XLR"-type connector, usually found on the nether end of what is called a "mic cable," to connect to a female XLR jack.

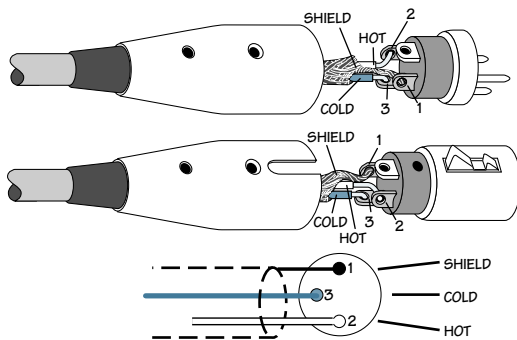

Figure A: XLR Connectors

## 1/4" TRS Phone Plugs and Jacks

"TRS" stands for Tip-Ring-Sleeve, the three connections available on a "stereo" 1/4" or "balanced" phone jack or plug. See Figure B.

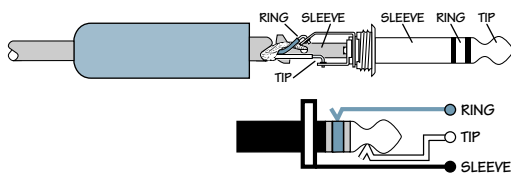

Figure B: 1/4" TRS Plugs

TRS jacks and plugs are used in several different applications:

- Balanced mono circuits. When wired as a balanced connector, a 1/4" TRS jack or plug is connected tip to signal high (hot), ring to signal low (cold), and sleeve to ground (earth).
- Stereo Headphones, and rarely, stereo microphones and stereo line connections. When wired for stereo, a 1/4" TRS jack or plug is connected tip to left, ring to right and sleeve to ground (earth). Mackie mixers do not

directly accept 1-plug-type stereo microphones. They must be separated into a left cord and a right cord, which are plugged into the two mic preamps.

You can cook up your own adapter for a stereo microphone. "Y" two cables out of a female 1/4" TRS jack to two male XLR plugs, one for the Right signal and one for the Left.

- Unbalanced Send/Return circuits. When wired as a send/return "Y" connector, a 1/4" TRS jack or plug is connected tip to signal send (output from mixer), ring to signal return (input back into mixer), and sleeve to ground (earth).

## 1/4" TS Phone Plugs and Jacks

"TS" stands for Tip-Sleeve, the two connections available on a "mono" 1/4" phone jack or plug. See Figure C.

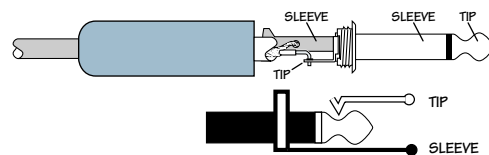

Figure C: TS Plug

TS jacks and plugs are used in many different applications, always unbalanced. The tip is connected to the audio signal and the sleeve to ground (earth). Some examples:

- Unbalanced microphones
- Electric guitars and electronic instruments
- Unbalanced line-level connections

## RCA Plugs and Jacks

RCA-type plugs (also known as phono plugs) and jacks are often used in home stereo and video equipment and in many other applications (Figure D). They are unbalanced and electrically identical to a 1/4" TS phone plug or jack (figure C). Connect the signal to the center post and the ground (earth) or shield to the surrounding "basket."



Figure D: RCA Plug

## TRS Send/Receive Insert Jacks

Mackie's single-jack inserts are the three-conductor, TRS-type 1/4" phone. They are unbalanced, but have both the mixer output (send) and the mixer input (return) signals in one connector. See Figure E.

The sleeve is the common ground (earth) for both signals. The send from the mixer to the external unit is carried on the tip, and the return from the unit to the mixer is on the ring.

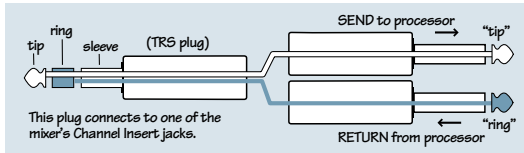

Figure E

## Using the Send Only on an Insert Jack

If you insert a TS (mono) 1/4" plug only partially (to the first click) into a Mackie insert jack, the plug will not activate the jack switch and will not open the insert loop in the circuit (thereby allowing the channel signal to continue on its merry way through the mixer).

This allows you to tap out the channel or bus signal without interrupting normal operation.

If you push the 1/4" TS plug in to the second click, you will open the jack switch and create a direct out, which does interrupt the signal in that channel. See Figure F.

NOTE: Do not overload or short-circuit the signal you are tapping from the mixer. That will affect the internal signal.

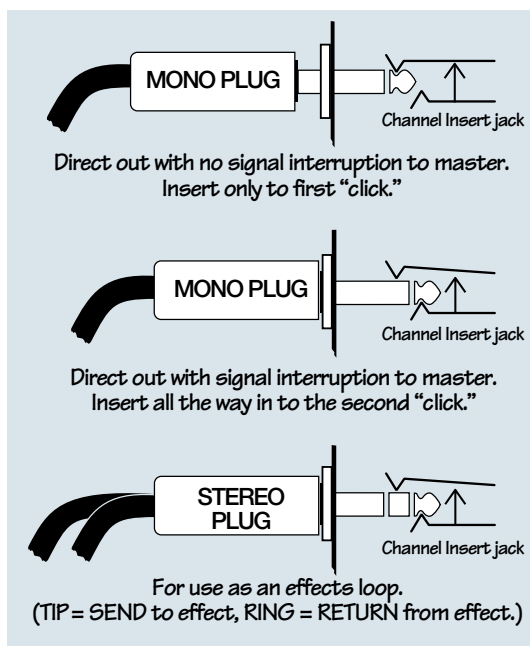

Figure F

## Mackie Stereo Inputs and Returns: Mono, Stereo, Whatever

Stereo line inputs and stereo returns are a fine example of the Mackie philosophy (which we just made up) of Maximum Flexibility with Minimum Headache. The inputs and returns will automatically be mono or stereo, depending upon how you use the jacks. Here's how it works:

A mono signal should be patched into the input or return jack labeled left (mono). The signal will be routed to both the left and right sides of the return circuit, and will show up in the center of the stereo pair of buses it's assigned to, or it can be panned with the pan [24] control.

A stereo signal, having two plugs, should be patched into the left (mono) and the right input or return jacks. A jack switch in the right jack will disable the mono function, and the signals will show up in stereo.

A mono signal connected to the right jack will show up in the right bus only. You probably will only want to use this sophisticated effect for special occasions.

## Microphone Stand

The bottom panel of the 802-VLZ3 has three non-threaded holes that allow it to be fitted with an optional microphone stand adapter. This allows you to support the mixer on a standard mic stand, and adjust its height and level to whatever suits your strangely-complex set of preferences.

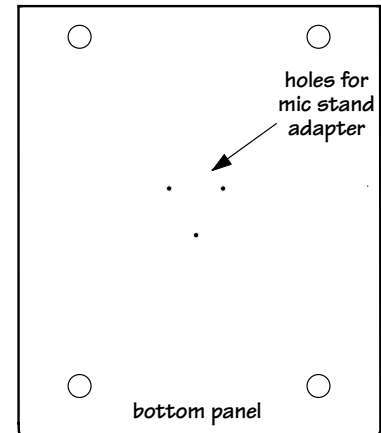

1. Order the Atlas AD-11B mic stand adapter available from many a fine music store. (It is made and distributed by Atlas Sound.)
2. Use three self-tapping machine screws 6-32 x 1/4" long to secure the adapter to the bottom of the 802-VLZ3.



Do not use screws that are longer than 1/4" as these could damage the circuit boards. Do not use any shorter screws, or the adapter will not be securely fixed to the mixer.



# Appendix C: Technical Information

## Specifications

### Main Mix Noise

(20 Hz–20 kHz bandwidth, channels 1–3 gain @ unity gain, channel EQ flat, all channels assigned to main mix, channel 1 panned left, 2 panned right, 3–8 centered.)

Main mix knob down, channel level knobs down:

XLR: -95 dBu  
TRS: -101 dBu

Main mix knob unity, channel level knobs down:

XLR: -90 dBu  
TRS: -96 dBu

Main mix knob @ unity, channel level knobs @ unity:

XLR: -84 dBu  
TRS: -90 dBu

### Total Harmonic Distortion (THD)

(1 kHz @ 35 dB gain, 20 Hz–20 kHz bandwidth)

Mic pre @ insert: 0.001%

### Attenuation (Crosstalk)

(1 kHz relative to 0 dBu, 20 Hz–20 kHz bandwidth, line in, 1/4" main out, gain @ unity.)

Main mix knob down: -75 dBu

Channel Alt / Mute switch engaged: -100 dBu

Channel level knob down: -100 dBu

### Frequency Response

(30 Hz to 30 kHz, mic input to any output, @ 60 dB gain.)

+0 dB/-1 dB

(10 Hz to 100 kHz, mic input to any output, @ unity gain.)

+0 dB/-3 dB

### Equivalent Input Noise (EIN)

(20 Hz–20 kHz, mic input to insert send out, max gain.)

150 ohm termination: -129.5 dBu

### Common Mode Rejection Ratio (CMRR)

(Mic in to insert send out, max gain.)

1 kHz: better than -60 dB

### Maximum Levels

Mic in: +21 dBu

Tape in: +22 dBu

All other inputs: +22 dBu

Main mix XLR out: +28 dBu

All other outputs: +22 dBu

### Impedances

Mic in: 3.4 kilohms

Channel insert return: 5 kilohms

All other inputs: 20 kilohms or greater

Tape out: 1 kilohms

Phones out: 60 ohms

All other outputs: 120 ohms

### EQ

High Shelving +15 dB @ 12 kHz

Mid Peaking +15 dB @ 2.5 kHz

Low Shelving +15 dB @ 80 Hz

### Power Consumption

13 watts

### Dimensions (H x W x D)

10.7" x 8.9" x 1.8" (273 mm x 227 mm x 47 mm)

### Weight

With power supply 5.5 lb (2.5 kg)

Without power supply 4.5 lb (2.0 kg)

LOUD Technologies Inc. is always striving to improve our products by incorporating new and improved materials, components, and manufacturing methods. Therefore, we reserve the right to change these specifications at any time without notice.

"Mackie," and the "Running Man" are registered trademarks of LOUD Technologies Inc. All other brand names mentioned are trademarks or registered trademarks of their respective holders, and are hereby acknowledged.

©2007 LOUD Technologies Inc. All Rights Reserved.

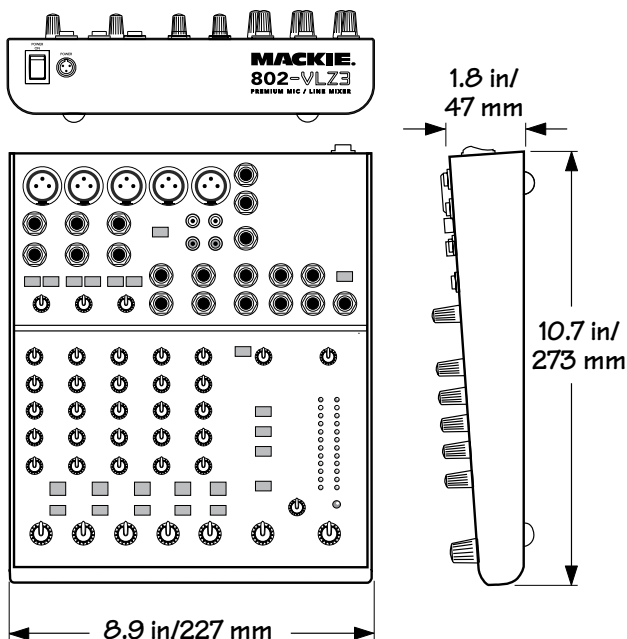

# Block Diagram

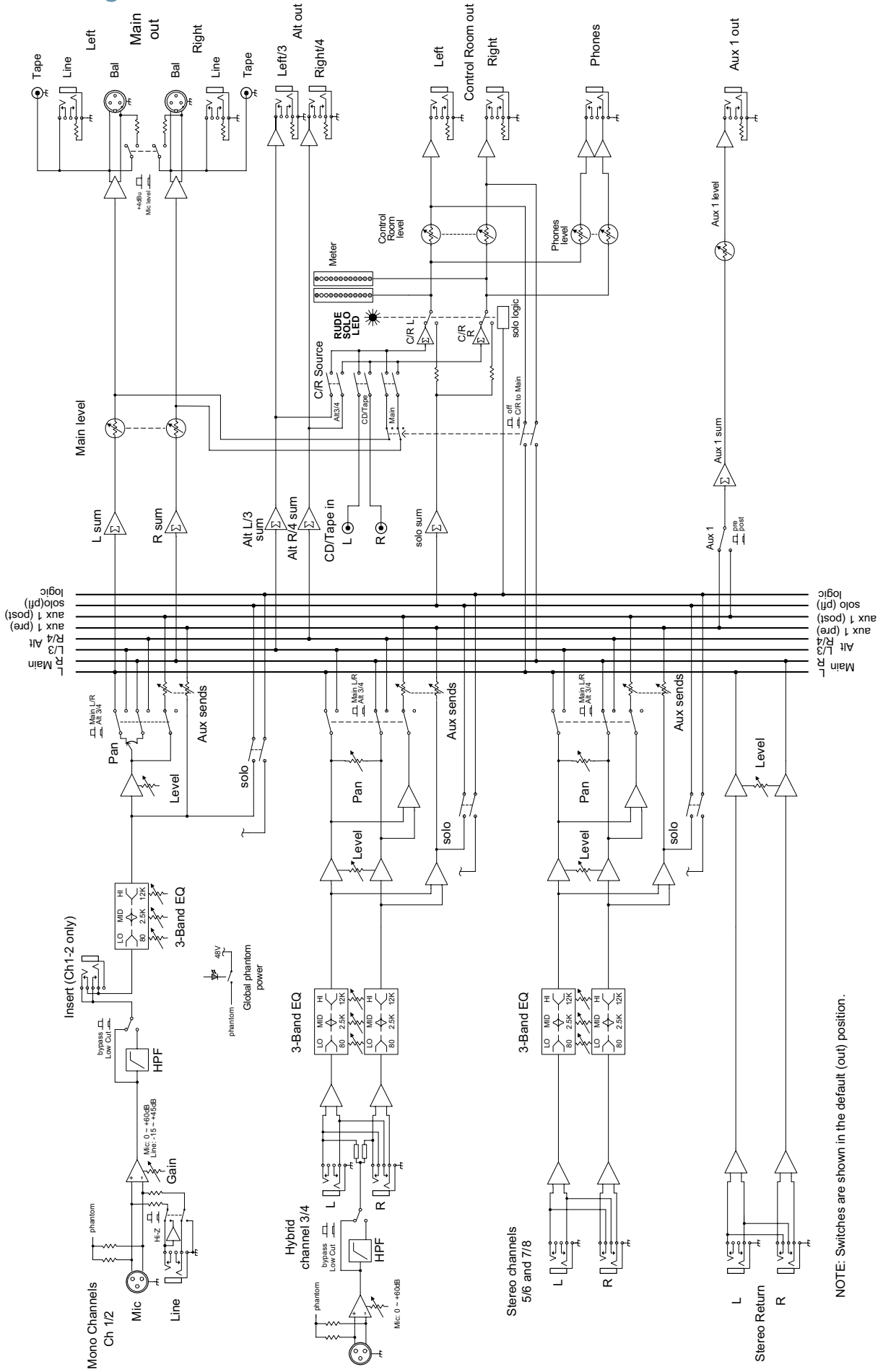

NOTE: Switches are shown in the default (out) position.

# 802-VLZ3 Limited Warranty

**Please keep your sales receipt in a safe place.**

A. LOUD Technologies Inc. warrants all materials, workmanship and proper operation of this product for a period of one year from the original date of purchase. You may purchase an additional 24-month Extended Warranty (for a total of 36 months of coverage). Visit our website and follow the "Product Registration" links for details ([www.mackie.com](http://www.mackie.com)). If any defects are found in the materials or workmanship or if the product fails to function properly during the applicable warranty period, LOUD Technologies, at its option, will repair or replace the product. **This warranty applies only to equipment sold and delivered within the U.S. and Canada by LOUD Technologies Inc. or its authorized dealers.**

B. For faster processing (not to mention a free gift), register online or mail in the product registration card.

C. Unauthorized service, repairs, or modification of Mackie products will void this warranty. To obtain repairs or replacement under warranty, you must have a copy of your sales receipt from the authorized Mackie dealer where you purchased the product. It is necessary to establish purchase date and determine whether your Mackie product is within the warranty period.

D. To obtain warranty repair or replacement:

1. Call Mackie Technical Support at 800/898-3211, 7 AM to 5 PM Monday through Friday (Pacific Time) to get authorization for repair or replacement. Alternately, go to the Mackie website, click "Support" ([www.mackie.com/support](http://www.mackie.com/support)), and follow the instructions for reporting a warranty issue and submitting a request for an advance replacement.

2. **Advance Replacement:** Mackie will ship a replacement unit to you along with an invoice for the suggested retail price of the replacement unit. You must return the defective unit immediately to cancel the invoice. If you do not return the defective unit within 30 days, you must pay the full amount stated in the invoice to satisfy your debt.

3. **Repair:** When you call Mackie Technical Support, explain the problem and obtain a Service Request Number. Have your Mackie product's serial number ready. You must have a Service Request Number before you can obtain factory-authorized service.

- Pack the product in its original shipping carton. Also include a note explaining exactly how to duplicate the problem, a copy of the sales receipt with price and date showing, your daytime phone number and return street address (no P.O. boxes or route numbers, please!), and the Service Request Number. If we cannot duplicate the problem or establish the starting date of your Limited Warranty, we may, at our option, charge for service time and parts.

- Ship the product in its original shipping carton, **freight prepaid** to the authorized service center. Write the Service Request Number in BIG PRINT on top of the box. The address of your closest authorized service center will be given to you by Technical Support, or it may be obtained from our website. Once it's repaired, the authorized service center will ship it back by ground shipping, pre-paid (if it qualified as a warranty repair).

**Note:** Under the terms of the warranty, you must ship or drop-off the unit to an authorized service center. The return ground shipment is covered for those units deemed by us to be under warranty.

**Note:** You must have a sales receipt from an authorized Mackie dealer for your unit to be considered for warranty repair.

**IMPORTANT: Make sure that the Service Request Number is plainly written on the shipping carton. No receipt, no warranty service.**

E. LOUD Technologies reserves the right to inspect any products that may be the subject of any warranty claims before repair or replacement is carried out. LOUD Technologies may, at our option, require proof of the original date of purchase in the form of a dated copy of the original dealer's invoice or sales receipt. Final determination of warranty coverage lies solely with LOUD Technologies.

F. Any products returned to one of the LOUD Technologies factory-authorized service centers, and deemed eligible for repair or replacement under the terms of this warranty will be repaired or replaced. LOUD Technologies and its authorized service centers may use refurbished parts for repair or replacement of any product. Products returned to LOUD Technologies that do not meet the terms of this Warranty will not be repaired unless payment is received for labor, materials, return freight, and insurance. Products repaired under warranty will be returned freight prepaid by LOUD Technologies to any location within the boundaries of the USA or Canada.

G. LOUD Technologies warrants all repairs performed for 90 days or for the remainder of the warranty period. This warranty does not extend to damage resulting from improper installation, misuse, neglect or abuse, or to exterior appearance. This warranty is recognized only if the inspection seals and serial number on the unit have not been defaced or removed.

H. LOUD Technologies assumes no responsibility for the timeliness of repairs performed by an authorized service center.

I. This warranty is extended to the original purchaser. This warranty may be transferred to anyone who may subsequently purchase this product within the applicable warranty period for a nominal fee (extended warranties are not transferable). A copy of the original sales receipt is required to obtain warranty repairs or replacement.

J. This is your sole warranty. LOUD Technologies does not authorize any third party, including any dealer or sales representative, to assume any liability on behalf of LOUD Technologies or to make any warranty for LOUD Technologies Inc.

K. THE WARRANTY GIVEN ON THIS PAGE IS THE SOLE WARRANTY GIVEN BY LOUD TECHNOLOGIES INC. AND IS IN LIEU OF ALL OTHER WARRANTIES, EXPRESS AND IMPLIED, INCLUDING THE WARRANTIES OF MERCHANTABILITY AND FITNESS FOR A PARTICULAR PURPOSE. THE WARRANTY GIVEN ON THIS PAGE SHALL BE STRICTLY LIMITED IN DURATION TO ONE YEAR FROM THE DATE OF ORIGINAL PURCHASE FROM AN AUTHORIZED MACKIE DEALER. UPON EXPIRATION OF THE APPLICABLE WARRANTY PERIOD, LOUD TECHNOLOGIES INC. SHALL HAVE NO FURTHER WARRANTY OBLIGATION OF ANY KIND. LOUD TECHNOLOGIES INC. SHALL NOT BE LIABLE FOR ANY INCIDENTAL, SPECIAL, OR CONSEQUENTIAL DAMAGES THAT MAY RESULT FROM ANY DEFECT IN THE MACKIE PRODUCT OR ANY WARRANTY CLAIM. Some states do not allow exclusion or limitation of incidental, special, or consequential damages or a limitation on how long warranties last, so some of the above limitations and exclusions may not apply to you. This warranty provides specific legal rights and you may have other rights which vary from state to state.

**MACKIE®**

---

**16220 Wood-Red Road NE • Woodinville, WA 98072 • USA**  
**United States and Canada: 800.898.3211**  
**Europe, Asia, Central and South America: 425.487.4333**  
**Middle East and Africa: 31.20.654.4000**  
**Fax: 425.487.4337 • [www.mackie.com](http://www.mackie.com)**  
**E-mail: [sales@mackie.com](mailto:sales@mackie.com)**