

Technical Specifications

IR-7S/IR-7B/IR-5C

Power	AC 120V~60Hz or AC 230/240/250V~50/60Hz	
Fuse	20mm Glass T10A Fast Blow	
Lamp	MSD 250/2 GY9.5	
Dimension	695 x 340 x 250 mm (IR-7S/IR-7B) 360 x 340 x 250 mm (IR-5C)	
Weight	15 kg (IR-7S/IR-7B) 9.2kg (IR-5C)	

IR-6SD/IR-6BD

Power	AC 120V~60Hz	AC 230/240/250V~50/60Hz
Fuse	20mm Glass T6.3A Fast Blow	
Lamp	CDM 150W	
Dimension	695 x 340 x 250 mm	
Weight	10.7 kg	

IR-6S/IR-6B/IR-5S/IR-5B/IR-4C

Power	AC 120V~60Hz	AC 230/240/250V~50/60Hz
Fuse	20mm Glass T6.3A Fast Blow	20mm Glass T5A Fast Blow
Lamp	ELC 24V 250W	
Dimension	695 x 340 x 250 mm (IR-6S/6B/5S/5B) 360 x 340 x 250 mm (IR-4C)	
Weight	10.6 kg (IR-6S/IR-6B/IR-5S/IR-5B) 8 kg (IR-4C)	

IS-6S/IS-6B/IS-3/IS-4

Power	AC 120V~60Hz	AC 230/240/250V~50/60Hz
Fuse	20mm Glass T6.3A Fast Blow	20mm Glass T5A Fast Blow
Lamp	ELC 24V 250W	
Dimension	685 x 380 x 200 mm (IS-6S/IS-6B) 375 x 380 x 200 mm (IS-4/IS-3)	
Weight	9.4 kg (IS-6S/IS-6B) 7.5 kg (IS-4/IS-3)	

Innovation , Quality , Performance

iSolution

Your integrated Solution



iRock-7B/iRock-6B
iRock-6BD/iRock-5B



iRock-7S/iRock-6S
iRock-6SD/iRock-5S



iRock-5C/iRock-4C



iShow-6S



iShow-6B



iShow-3/iShow-4

User Guide

Professional Entertainment Technology

7. Fixture Cleaning

The cleaning of internal and external optical lenses and/or mirrors must be carried out periodically to optimize light output. Cleaning frequency depends on the environment in which the fixture operates: damp, smoky or particularly dirty surrounding can cause greater accumulation of dirt on the unit's optics.

- Clean with soft cloth using normal glass cleaning fluid.
- Always dry the parts carefully.
- Clean the external optics at least every 20 days. Clean the internal optics at least every 30/60 days.

TABLE OF CONTENTS

1. Safety Instruction
2. Technical Specification
 - 2.1 Inserting/Exchanging rotating gobos
 - 2.2 Beam Angle
3. Lamp
4. How To Set The Unit
 - 4.1 Control Panel
 - 4.2 Main Function
5. How To Control The Unit
 - 5.1 Master/Slave Built-In Preprogrammed Function
 - 5.2 Easy Controller
 - 5.3 iSolution Operation / Universal DMX Controller
 - 5.4 Universal DMX Controller
 - 5.5 DMX512 Configuration
 - 5.6 DMX512 Connection
6. Troubleshooting
7. Fixture Cleaning

2H

EC Declaration of Conformity

We declare that our products (lighting equipments) comply with the following specification and bears CE mark in accordance with the provision of the Electromagnetic Compatibility (EMC) Directive 89/336/EEC.

EN55014-2: 1997 A1:2001, EN61000-4-2: 1995; EN61000-4-3:2002;
EN61000-4-4: 1995; EN61000-4-5: 1995, EN61000-4-6:1996,
EN61000-4-11: 1994.

&

Harmonized Standard

EN60598-1: 2000+ALL:2000+A12:2002
Safety of household and similar electrical appliances
Part 1 : General requirements

6. Troubleshooting

Following are a few common problems that may occur during operation. Here are some suggestions for easy troubleshooting:

A. The unit does not work, no light and the fan does not work

1. Check the connect power and main fuse.
2. Measure the mains voltage on the main connector.
3. Check the power on LED.

B. Not responding to DMX controller

1. DMX LED should be on. If not, check DMX connectors, cables to see if link properly.
2. If the DMX LED is on and no response to the channel, check the address settings and DMX polarity.
3. If you have intermittent DMX signal problems, check the pins on connectors or on PCB of the unit or the previous one.
4. Try to use another DMX controller.
5. Check in the DMX cables run near or run alongside to high voltage cables that may cause damage or interference to DMX interface circuit.

C. Some units don't respond to the easy controller

1. You may have a break in the DMX cabling. Check the LED for the response of the master/ slave mode signal.
2. Wrong DMX address in the unit. Set the proper address.

D. No response to the sound

1. Make sure the unit that does not receive DMX signal.
2. Check microphone to see if it is good by tapping the microphone

E. One of the channels is not working well

1. The stepper motor might be damaged or the cable connected to the PCB is broken.
2. The motor's drive IC on the PCB might be out of condition.

F. The lamp is cutting out intermittently

1. The lamp is not working well. Check the main voltage either too high or too low.
2. Internal temperature may be too high. Check and if necessary replace the fan on the head.

1. Safety Instruction



WARNING

Please read carefully the instruction, which includes important information about installation, operation and maintenance.

3H

- ◆ Please keep this User Guide for future consultation. If you sell the unit to another user, be sure that they also receive this user guide.
- ◆ Unpack and check carefully there is no transportation damage before using the unit.
- ◆ Before operating, ensure that the voltage and frequency of power supply match the power requirements of the unit.
- ◆ It's important to ground the yellow/green conductor to earth in order to avoid electric shock.
- ◆ The unit is for indoor use only. Use only in a dry location.
- ◆ The unit must be installed in a location with adequate ventilation, at least 50cm from adjacent surfaces. Be sure that no ventilation slots are blocked.
- ◆ Disconnect main power before fuse/lamp replacement or servicing.
- ◆ Replace fuse/lamp only with the same type. Do not use any other type of lamp.
- ◆ Make sure there is no flammable materials close to the unit while operating as it is fire hazard.
- ◆ Use safety cable when fixes this unit. Don't handle the unit by taking its head only, but always by taking its base.
- ◆ Maximum ambient temperature is TA: 40°C. Don't operate it where the temperature is higher than this.
- ◆ Unit surface temperature may reach up to 85C. Don't touch the housing bare-hand during its operation. Turn off the power and allow about 15 minutes for the unit to cool down before replacing bulb or serving as the unit could be very hot.
- ◆ In the event of serious operating problem, stop using the unit immediately. Never try to repair the unit by yourself. Repairs carried out by unskilled people can lead to damage or malfunction. Please contact the nearest authorized technical assistance center. Always use the same type spare parts.
- ◆ Don't connect the device to any dimmer pack or power pack.
- ◆ Do not touch any wire during operation as high voltage might be causing electric shock.

Warning

- ◆ To prevent or reduce the risk of electrical shock or fire, do not expose the unit to rain or moisture.
- ◆ Never touch bulb with bare fingers as it is very hot after using.
- ◆ Hot lamp explosion hazard. Do not open the unit within five minutes after switching off.
- ◆ Do not start on the unit without bulb enclosure or housing are damaged.
- ◆ The housing, the lenses, or the ultraviolet filter must be replaced if they are visibly damaged.
- ◆ Do not look directly at the light while the bulb is on.

Caution

There are no user serviceable parts inside the unit. Do not open the housing or attempt any repairs yourself. In the unlikely event your unit may require service, please contact your nearest dealer.

Installation

The unit should be mounted via its screw holes on the bracket. Always ensure that the unit is firmly fixed to avoid vibration and slipping while operating. Always ensure that the structure to which you are attaching the unit is secure and is able to support a weight of 20 kgs for each unit.





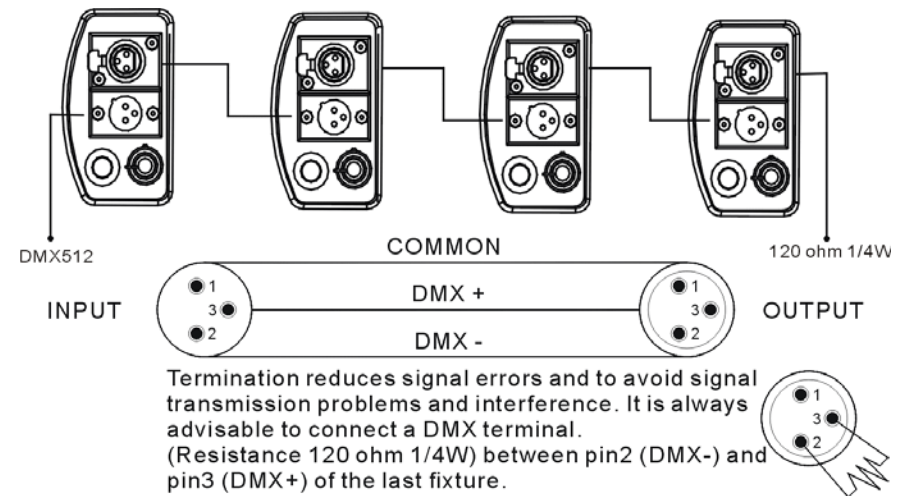





















5.5 DMX512 Connection

The DMX512 is widely used in intelligent lighting control, with a maximum of 512 channels.



4H

- 1.If you using a controller with 5 pins DMX output, you need to use a 5 to 3 pin adapter-cable.
- 2.At last unit, the DMX cable has to be terminated with a terminator. Solder a 120 ohm 1/4W resistor between pin 2(DMX-) and pin 3(DMX+) into a 3-pin XLR-plug and plug it in the DMX-output of the last unit.
- 3.Connect the unit together in a `daisy chain` by XLR plug from the output of the unit to the input of the next unit. The cable can not branched or split to a `Y` cable. DMX512 is a very high-speed signal. Inadequate or damaged cables, soldered joints or corroded connectors can easily distort the signal and shut down the system.
- 4.The DMX output and input connectors are pass-through to maintain the DMX circuit, when power is disconnected to the unit.
- 5.Each lighting unit needs to have an address set to receive the data sent by the controller. The address number is between 0-511 (usually 0 & 1 are equal to 1).
- 6.The end of the DMX512 system should be terminated to reduce signal errors.
- 7.3 pin XLR connectors are more popular than 5 pin XLR.
 - 3 pin XLR: Pin 1: GND, Pin 2: Negative signal (-), Pin 3: Positive signal (+)
 - 5 pin XLR: Pin 1: GND, Pin 2: Negative signal (-), Pin 3: Positive signal (+)

DMX512 Configuration			
Ch1	Ch2	Ch3	Ch4
Shutter/Shaking	Gobo	No function	Reflector
248-255 Open	255 Fastest speed Gobo change 		246-255 Stopped
247 Fastest speed Shaking 	128 Slowest speed Gobo change 		245 Fastest speed clockwise 
	120-127 White 		
132 Slowest speed shaking	111-119 Magenta 		135 Slowest speed clockwise 
131 Fastest speed shutter 	103-110 Blue+Magenta 		121-134 Stopped
16 Slowest speed shutter 	094-102 Blue+Magenta 		120 Slowest speed counterclockwise 
008-015 Open	086-093 Red 		010 Fastest speed counterclockwise 
000-007 Blackout	077-085 UV Purple 		000-009 Stopped
	069-076 Yellow 		
	060-068 Green+Yellow 		
	052-059 Magenta 		
	043-051 Green+Magenta+Blue 		
	035-042 Blue 		
	026-034 Green 		
	018-025 Magenta 		
	009-017 Red 		
	000-008 White 		

5H

2. Technical Specification

- Voltage : AC 120V~60Hz or 230V/240V/250V~50/60Hz
- Bulb : MSD 250/2 GY9.5 (IR-7S/IR-7B/IR-5C) CDM 150W (IR-6SD/IR-6BD)
ELC 24V 250W (IR-6S/IR-6B /IR-5S/IR-5B/ IR-4C/IS-6S/IS-6B/IS-4/IS-3)
- The unit is DMX512 fixture. It features full DMX512 control. It can also be linked together in master/slave connection, as many as required in and run by built-in program chase sequences automatically or by sound activation through an internal microphone to create an intelligent effect.
- It can be operated by DMX512 control or can be used as an individual unit without a controller
- Consistent DMX channel enable iRock, iShow and iMove to be link together.
- Features different preprogrammed chase patterns.
- Please use a 3 pin XLR cable/plug when connecting units together.
- Accurate focusable optics system and ultra smooth stepping motors. Fan cooling.
- Pan : 180 deg. Tilt : 70 deg. (IR-7S/IR-7B/IR-6SD/IR-6BD/IR-6S/IR-6B/IR-5S/IR-5B/IS-6S/IS-6B)
- **IR-7S/IR-7B** Independent gobo wheel with 7 rotating, replaceable gobos plus open, including 4 metal, 2 glass and 1 effect gobos with shaking effect, Independent color wheel with 9 dichroic colors with rainbow effect, and independent shutter & dimmer.
- **IR-6S/IR-6B** Independent gobo wheel with 14 gobos plus open and blackout, including 10 metal, 1 replaceable gobo, 2 glass and 1 effect gobos with shaking effect, Independent color wheel with 11 dichroic colors with rainbow effect, and independent shutter & dimmer. (IR-5S/IR-5B without dimmer).
- **IR-5C** Independent gobo wheel with 7 rotating, replaceable gobos plus open, including 1 metal, 2 glass, 1 effect, 1 frost gobos, and 2 color temperature filters (5600k & 3200k) with shaking effect, Independent color wheel with 9 dichroic colors with rainbow effect, and independent shutter & dimmer.
- **IR-4C** Independent gobo wheel with 14 gobos plus open and blackout, including 7 metal, 1 replaceable, 1 effect, 1 frost, 2 glass, gobos, and 2 color temperature filters (5600k & 3200k), with shaking effect, Independent color wheel with 11 dichroic colors with rainbow effect, and independent shutter & dimmer.
- **IS-6S/IS-6B/IS-4** Professional multi-gobo rotator 14 gobos plus open and blackout, including 10 metal, 1 replaceable gobo, 2 glass and 1 effect gobos, with shaking and shutter effect, Independent color wheel with 11 dichroic colors with rainbow effect.
- **IS-3** Professional multi-gobo rotator 14 gobos/colors plus open and blackout, including 10 metal, 1 replaceable gobo, 2 glass and 1 effect gobos, with shaking and shutter effect.

2.1 Inserting/Exchanging rotating gobos

(For IR-7S/IR-7B/ IR-5C only !)

DANGER!
 Install the gobos with the device switched off only.
 Unplug from mains before!

Open the cover by loosening the fastening screw at the sides of the cover.
 If you wish to use other forms and patterns as the standard-gobos, or if the gobos are to be exchanged, remove the fixation ring with an appropriate tool. Remove the gobo and insert the new gobo. Press the fixation-ring together and insert it in the front of the gobo.

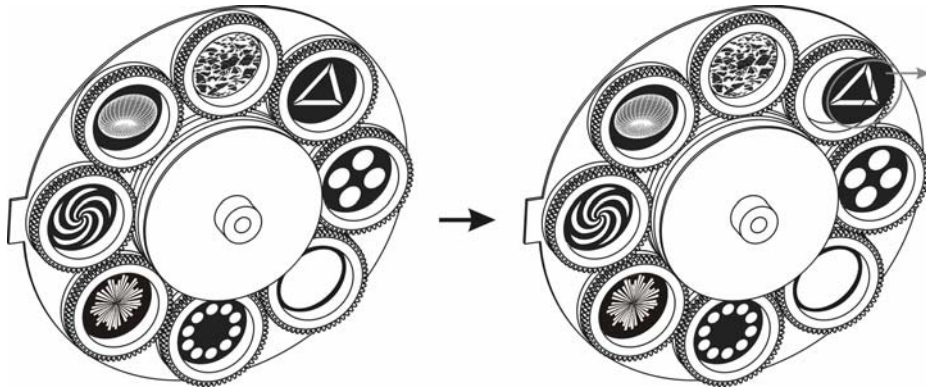

CAUTION!
 Never unscrew the screws of the rotating gobo as the ball bearing will otherwise be opened!

IS-6S/IS-6B/IS-4 (IS-4 is a 4 channel gobo rotator)

DMX512 Configuration				
Ch1	Ch2	Ch3	Ch4	
Pan	Tilt	Barrel	Shutter/Shaking	Gobo
		246-255 Stopped	248-255 Open	255 Fastest speed Gobo change
		245 Fastest speed clockwise	247 Fastest speed Shaking	128 Slowest speed Gobo change
				120-127
				111-119
		135 Slowest speed clockwise	132 Slowest speed shaking	103-110
		121-134 Stopped	131 Fastest speed shutter	094-102
		120 Slowest speed counterclockwise		086-093
			16 Slowest speed shutter	077-085
				069-076
		010 Fastest speed counterclockwise	008-015 Open	060-068
000-009 Stopped	000-007 Blackout	052-059		
			043-051	
			035-042	
			026-034	
			018-025	
			009-017	
			000-008	
Ch5			Ch6	
Color			Reflector	
Normal		Split		
255 Fastest speed Rainbow effect		255 Fastest speed Rainbow effect		
128 Slowest speed Rainbow effect		128 Slowest speed Rainbow effect		
118-127 Pink		121-127 Pink		
107-117 Yellow		113-120 Yellow+Pink		
096-106 Orange		108-112 Yellow		
086-095 Light Green		098-105 Orange+Yellow		
075-085 UV Purple		091-097 Orange		
064-074 Blue		083-090 Light Green+Orange		
054-063 Red		076-082 Light Green		
043-053 Amber		068-075 UV Purple		
032-042 Light Blue		061-067 Blue		
022-031 Magenta		053-060 Red+Blue		
011-021 Green		046-052 Red		
000-010 White		038-045 Amber		
		031-037 Light Blue		
		023-030 Magenta		
		016-022 Green+Magenta		
		008-015 Green		
		000-007 White		
		246-255 Stopped		
		245 Fastest speed clockwise		
		135 Slowest speed clockwise		
		121-134 Stopped		
		120 Slowest speed counterclockwise		
		010 Fastest speed counterclockwise		
		000-009 Stopped		

6H

IR-6SD/IR-6BD/IR-6S/IR-6B/IR-5S/IR-5B/IR-4C (IR-4C is a 4 channel color changer)

DMX512 Configuration			
Ch1	Ch2		Ch3
Pan	Tilt	Barrel	Shutter/Shaking
		246-255 Stopped	248-255 Open
		245 Fastest speed clockwise	247 Fastest speed Shaking
		135 Slowest speed clockwise	132 Slowest speed shaking
		121-134 Stopped	131 Fastest speed shutter
		120 Slowest speed counterclockwise	
			16 Slowest speed shutter
		010 Fastest speed counterclockwise	008-015 Open
		000-009 Stopped	000-007 Blackout
			128 Slowest speed Gobo change
			120-127
			111-119
			103-110
			094-102
			086-093
			077-085
			069-076
			060-068
			052-059
			043-051
			035-042
			026-034
			018-025
			009-017
			000-008
			Frost
			5600K
			3200K
Ch5		Ch6	Ch7
Color		No function	Dimmer
Normal	Split		100%
255 Fastest speed Rainbow effect	255 Fastest speed Rainbow effect		
			0
128 Slowest speed Rainbow effect	128 Slowest speed Rainbow effect		
118-127 Pink	121-127 Pink		
107-117 Yellow	113-120 Yellow+Pink		
096-106 Orange	106-112 Yellow		
086-095 Light Green	098-105 Orange+Yellow		
075-085 UV Purple	091-097 Orange		
064-074 Blue	083-090 Light Green+Orange		
054-063 Red	076-082 Light Green		
043-053 Amber	068-075 UV Purple		
032-042 Light Blue	061-067 Blue		
022-031 Magenta	053-060 Red+Blue		
011-021 Green	046-052 Red		
000-010 White	038-045 Amber		
	031-037 Light Blue		
	023-030 Magenta		
	016-022 Green+Magenta		
	008-015 Green		
	000-007 White		

2.2 Beam Angel

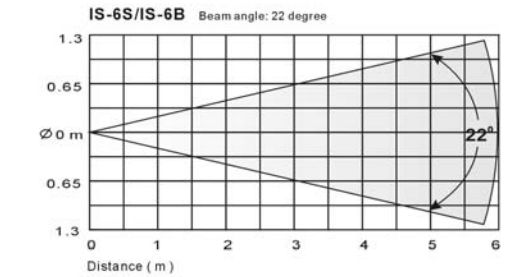
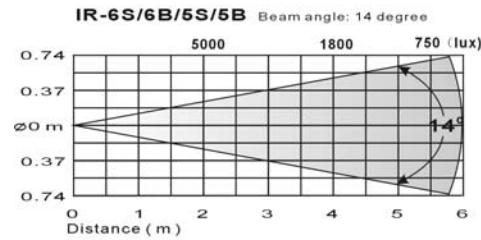
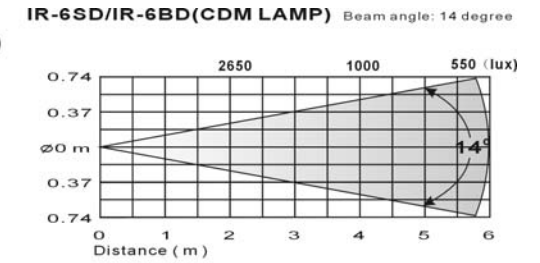
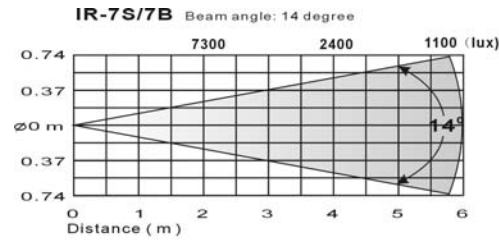

7H

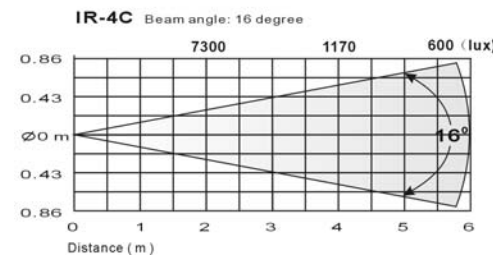
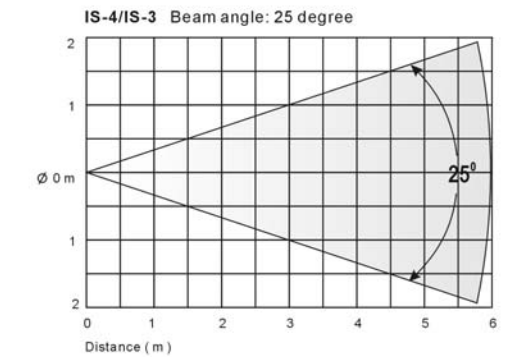
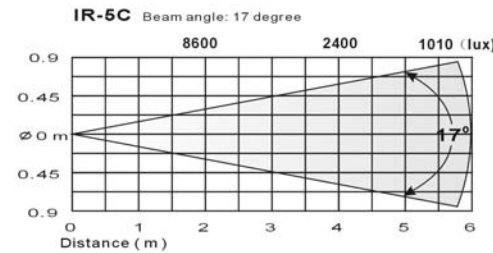

3. Lamp



In case of replacement of the lamp or maintenance, do not open the fixture within 15 minutes until the unit cools down after switching off.

MSD 250/2 GY 9.5 (IR-7S/7B/IR-5C) CDM 150W (IR-6SD/ IR-6BD)
 ELC 24V 250W (IR-6S/IR-6B/IR-5S/IR-5B/ IR-4C/IS-6S/IS-6B/IS-4/IS-3)

Diagram for lamp changing

Because of its high internal pressure, there might be a risk that the Discharge lamp would explode during operation. The lamp emits intense UV radiation which is harmful to the eyes and skin. The high luminance of the arc can cause severe damage to the retina if looks directly at the lamp.

1. Always switch off the main supply and never handle the lamp or luminaries when is hot.
2. Do not touch the bulb with bare hands. If this happens, clean the lamp with denatured alcohol and wipe it with a lint free cloth before installation.
3. The lamp generates UV radiation. Never operate the lamp without appropriate shielding.
4. When burning, the lamp operates at high pressure and

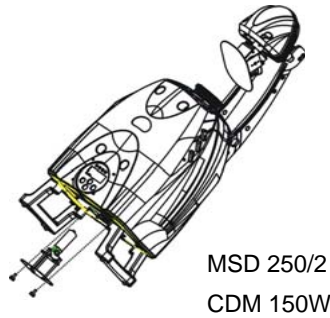

MSD 250/2
CDM 150W

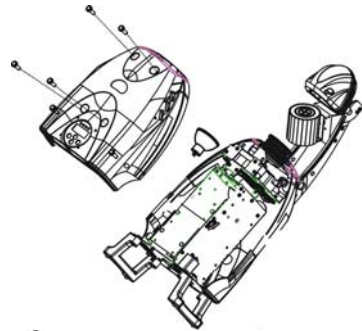

8H

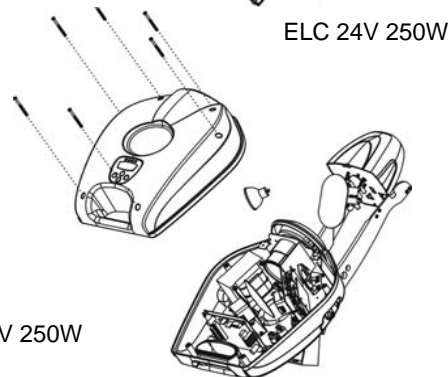

ELC 24V 250W

ELC 24V 250W

Make sure the lamp is located in the center of the reflector for the best spot.

IR-7S/7B/5C (IR-5C is a 5 channel color changer)

DMX512 Configuration							
Ch1	Ch2		Ch3	Ch4			
Pan	Tilt	Barrel	Shutter/Shaking	Gobo		IR-5C	
		246-255 Stopped	248-255 Open	255 Fastest speed Gobo change			
		245 Fastest speed clockwise	247 Fastest speed Shaking				
				128 Slowest speed Gobo change			
		135 Slowest speed clockwise		112-127			5600K
		121-134 Stopped	132 Slowest speed shaking	096-111			3200K
		120 Slowest speed counterclockwise	131 Fastest speed shutter	080-095			Frost
				064-079			
		010 Fastest speed counterclockwise	16 Slowest speed shutter	048-063			
		000-009 Stopped	008-015 Open	032-047			
			000-007 Blackout	016-031			
		000-015					
Ch5			Ch6	Ch7			
Color			R-gobo	Dimmer			
Normal		Split	246-255 Stopped				
255 Fastest speed Rainbow effect	255 Fastest speed Rainbow effect	245 Fastest speed clockwise					
128 Slowest speed Rainbow effect	128 Slowest speed Rainbow effect						
121-127 Pink	113-120 Light Green	135 Slowest speed clockwise					
116-127 Pink	106-112 UV Purple+light Green	121-134 Stopped					
103-115 Light Green	098-105 UV Purple	120 Slowest speed counterclockwise					
090-102 UV Purple	091-097 Blue+UV Purple						
077-089 Blue	083-090 Blue						
064-076 Orange	076-082 Orange+Blue						
052-063 Yellow	068-075 Orange						
039-051 Light Blue	061-067 Yellow+Orange						
026-038 Magenta	053-060 Yellow						
013-025 Green	046-052 Light Blue+Yellow						
000-012 White	038-045 Light Blue	010 Fastest speed counterclockwise					
	031-037 Magenta+Light Blue	000-009 Stopped					
	023-030 Magenta						
	016-022 Green+Magenta						
	008-015 Green						
	000-007 White						

5. 4 DMX512 Configuration

Model	CH1	CH2	CH3	CH4	CH5	CH6	CH7
IR-7S	Pan	Tilt	Shutter /Shaking	Gobo	Color	Gobo Rotation	Dimmer
IR-7B	Pan	Barrel Rotation	Shutter /Shaking	Gobo	Color	Gobo Rotation	Dimmer
IR-6SD/6S	Pan	Tilt	Shutter /Shaking	Gobo	Color	No Function	Dimmer
IR-6BD/6B	Pan	Barrel Rotation	Shutter /Shaking	Gobo	Color	No Function	Dimmer
IR-5S	Pan	Tilt	Shutter /Shaking	Gobo	Color		
IR-5B	Pan	Barrel Rotation	Shutter /Shaking	Gobo	Color		
IR-5C	Shutter /Shaking	Gobo	Color	Gobo Rotation	Dimmer		
IR-4C	Shutter /Shaking	Gobo	Color	No Function	Dimmer		
IS-6S	Pan	Tilt	Shutter /Shaking	Gobo	Color	Reflector	
IS-6B	Pan	Barrel Rotation	Shutter /Shaking	Gobo	Color	Reflector	
IS-4	Shutter /Shaking	Gobo	Color	Reflector			
IS-3	Shutter /Shaking	Gobo /Color	No Function	Reflector			

4. How To Set The Unit

4.1 Control Panel

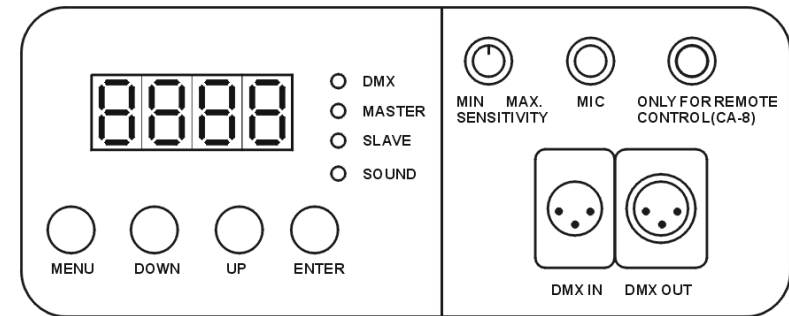

Display

To show the various menu and the selected functions.

LED

DMX	On	DMX input present
MASTER	On	Master Mode
SLAVE	On	Slave Mode
SOUND	Flashing	Sound activation

Button

MENU	to select the programming functions
DOWN	to go backward in the selected functions
UP	to go forward in the selected functions
ENTER	to confirm the selected functions

Remote controller input

By connect to the 1/4" microphone jack to control the unit for Stand by, Function and Mode.

Sensitivity

To adjust the sound sensitivity.

Microphone

To receives audio signal for sound activation.

DMX input/output

For DMX512 link, use 3-pin XLR plug cable to link the unit together.

4.2 Main Function

To select any of the given functions, press the **MENU** button up to when the required one is showing on the display. Select the function by **ENTER** button and the display will blink. Use **DOWN** and **UP** button to change the mode. Once the required mode has been selected, press the **ENTER** button to setup or it will automatically return to the main functions without any change after idling 8 seconds. To go back to the functions without any change press the **MENU** button. The main functions are showing below:

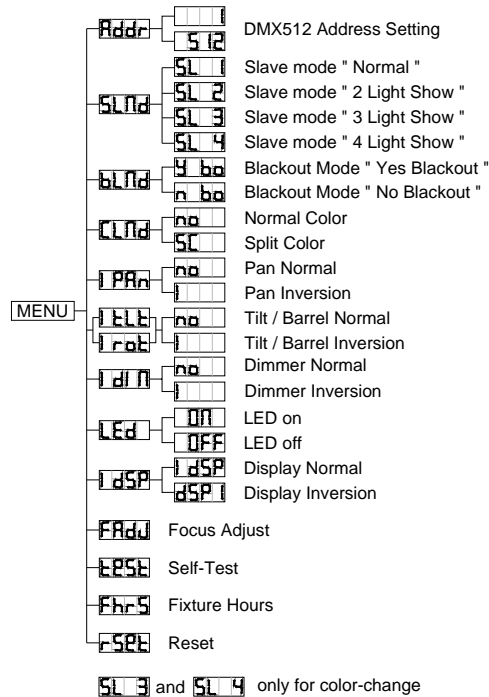

Addr

DMX512 Address Setting

Press the **MENU** button up to when the **Addr** is showing on the display. Pressing **ENTER** button and the display will blink. Use **DOWN** and **UP** button to change the DMX512 address. Once the address has been selected, press the **ENTER** button to setup or automatically return to the main functions without any change after 8 seconds. To go back to the functions without any change press the **MENU** button again.

SLNd

Slave Mode

5.3.1 iSolution Operation

- ◆ Consistent DMX configuration enable iRock and iShow to be linked together and controlled at the same time.
- ◆ DMX address can be set remotely by iLead controller (please refer to the user manual of iLead controller). No need to calculate the DMX channels of each fixture in the chain.
- ◆ Automatic switching between DMX function and built-in stand alone programs.

5.3.2 DMX Controller

An universal DMX controller to control the units, you have to set DMX address from 1 to 512 channel so that the units can receive DMX signal.

Press the **MENU** button up to when the **Addr** is showing on the display. Pressing **ENTER** button and the display will blink. Use **DOWN** and **UP** button to change the DMX512 address. Once the address has been selected, press and keep **ENTER** button pressed up to when the display stops blinking or storing automatically 8 seconds later. To go back to the functions without any change press the **MENU** button again.

Please refer to the following diagram to address your DMX512 channel for the first 4 units. DMX address can be set remotely by IL-0824 controller. No need to calculate the DMX channels of each fixture in the chain.

10H

(Following DMX address setting is based on that all the lighting fixtures are linked together controlled by the 8-channel iLead IL-0824 controller.)

IR-7S/IR-7B/IR-6S/IR-6B/IR-6SD/IR-6BD/IR-5S/IR-5B/IS-6S/IS-6B:



IR-5C/IR-4C/IS-4/IS-3:



5.2 Easy Controller

The easy remote control is used only in master/slave mode. By connecting to the 1/4" microphone jack of the first unit, you will find that the remote control on the first unit will control all the other units as below.

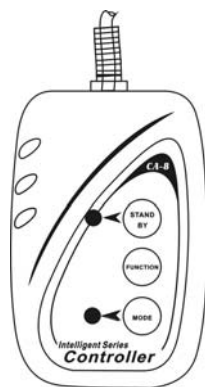

Built-in lighting shows triggered by Easy Controller:

IR-7S IR-7B IR-6SD IR-6BD IR-6S IR-6B IR-5S IR-5B	Stand by	Blackout the unit			
	Function	Strobe 1.Gobo/Color sync. strobe 2.Sync. strobe 3.Two-light strobe	X/Y moving pattern selection (12 patterns)	Color/Gobo selection 1. Hold on for gobo change. 2. Press shortly for color change.	X/Y moving setting 1.Pan position 2.Tilt position 3.Dimmer
	Mode	Sound 1 (LED off)	Sound 2 (LED normal blinking)	Slow/Sound 3 (LED on)	Position/ Latch (LED fast blinking)
IR-5C IR-4C	Stand by	Blackout the unit			
	Function	Strobe 1.Gobo/Color sync. strobe 2.Sync. strobe 3.Two-light strobe	Chase pattern selection (6 patterns)	Color/Gobo selection 1. Hold on for gobo change. 2. Press shortly for color change.	Dimmer setting
	Mode	Sound 1 (LED off)	Sound 2 (LED normal blinking)	Slow (LED on)	Latch (LED fast blinking)
IS-6S IS-6B	Stand by	Blackout the unit			
	Function	Strobe 1.Gobo/Color sync. strobe 2.Sync. strobe 3.Two-light strobe	X/Y moving pattern selection (12 patterns)	Color/Gobo selection 1. Hold on for gobo change. 2. Press shortly for color change.	X/Y moving setting 1.Pan position 2.Tilt position
	Mode	Sound 1 (LED off)	Sound 2 (LED normal blinking)	Slow/Sound 3 (LED on)	Position/ Latch (LED fast blinking)
IS-4	Stand by	Blackout the unit			
	Function	Strobe 1.Gobo/Color sync. strobe 2.Sync. strobe 3.Two-light strobe	Gobo/Color selection 1.Hold on for gobo change. 2.Press shortly for color change.		
	Mode	Sound (LED off)	Slow (LED on)		
IS-3	Stand by	Blackout the unit			
	Function	Strobe 1.Gobo/Color sync. strobe 2.Sync. strobe 3.Two-light strobe	Gobo/Color selection		
	Mode	Sound (LED off)	Slow (LED on)		

X/Y moving pattern



Press the **MENU** button up when the **SL0d** is showing on the display. Pressing **ENTER** button and the display will blink. Use **DOWN** and **UP** button to select the **SL1** (normal) or **SL2** (2 light show) mode or **SL3** (3 light show) mode or **SL4** (4 light show). Once the mode has been selected, press the **ENTER** button to setup or automatically return to the main functions without any change after 8 seconds. To go back to the functions without any change press the **MENU** button again.

BL0d Blackout Mode

Press the **MENU** button up when the **BL0d** is showing on the display. Pressing **ENTER** button and the display will blink. Use **DOWN** and **UP** button to select the **Y bo** (yes blackout) or **n bo** (no blackout) mode. Once the mode has been selected, press the **ENTER** button to setup or automatically return to the main functions without any change after 8 seconds. To go back to the functions without any change press the **MENU** button again.

CL0d Color Mode

Press the **MENU** button up when the **CL0d** is showing on the display. Pressing **ENTER** button and the display will blink. Use **DOWN** and **UP** button to select the **no** (normal) or **SC** (split color) mode. Once the mode has been selected, press the **ENTER** button to setup or automatically return to the main functions without any change after 8 seconds. To go back to the functions without any change press the **MENU** button again.

IPAn Pan Inversion

Press the **MENU** button up when the **IPAn** is showing on the display. Pressing **ENTER** button and the display will blink. Use **DOWN** and **UP** button to select the **no** (normal) or **I** (pan inversion) mode. Once the mode has been selected, press the **ENTER** button to setup or automatically return to the main functions without any change after 8 seconds. To go back to the functions without any change press the **MENU** button again.

ITLT Tilt Inversion **Irot** Barrel Rotation Inversion

Press the **MENU** button up when the **ITLT** (**Irot**) is showing on the display. Pressing **ENTER** button and the display will blink. Use **DOWN** and **UP** button to select the **no** (normal) or **I** (tilt/barrel rotation inversion) mode. Once the mode has been selected, press the **ENTER** button to setup or automatically return to the main functions without any change after 8 seconds. To go back to the functions without any change press the **MENU** button again.

1 d i n

Dimmer Inversion

Press the **MENU** button up to when the 1 d i n is shown on the display. Pressing **ENTER** button and the display will blink. Use **DOWN** and **UP** button to select the n o (normal) or (dimmer inversion) mode. Once the mode has been selected, press the **ENTER** button to setup or automatically return to the main functions without any change after 8 seconds. To go back to the functions without any change press the **MENU** button again.

L E d

Led Display

Press the **MENU** button up to when the L E d is showing on the display. Pressing **ENTER** button and the display will blink. Use **DOWN** and **UP** button to select the O N (Led on) or O F F (Led off) mode. Once the mode has been selected, press the **ENTER** button to setup or automatically return to the main functions without any change after 8 seconds. To go back to the functions without any change press the **MENU** button again.

1 d s p

Display Inversion

It is good for you to install the unit on the floor or under ceiling. Press the **MENU** button up to when the 1 d s p is blinking on the display. Use the **ENTER** button to change to the mode d s p (display inversion), It will automatically store after 8 seconds. Or press the **ENTER** button again return to the mode 1 d s p (display normal). To go back to the functions press the **MENU** button again.

1 d s p

Display normal mode for the fixture putting on the floor.

d s p

Display inversion mode for the fixture fixing under ceiling.

F R d U

Focus Adjust

Press the **MENU** button up to when the F R d U is blinking on the display. Pressing **ENTER** button, the unit will focus on center position. To go back to the functions press the **MENU** button again.

t e s t

Self-Test

Press the **MENU** button up to when the t e s t is blinking on the display. Pressing **ENTER** button and the unit will run self-test by built in program. To go back to the functions press the **MENU** button again.

F h r S

Fixture Hours

Press the **MENU** button up to when the F h r S is blinking on the display. Pressing **ENTER** button and the display will show the number of working hours of the unit. To go back to the functions press the **MENU** button again.

r s e t

Reset

Press the **MENU** button up to when the r s e t is blinking on the display. Pressing **ENTER** button and all channels of the unit will return to their standard position. To go back to the functions press the **MENU** button again.

5. How To Control The Unit

You can operate the unit in three ways:

1. By master/slave built-in preprogram function
2. By easy controller
3. By IL-0824 (please refer to the user guide of iLead controller) or universal DMX controller

12H

No need to turn the unit off when you change the DMX address, as new DMX address setting will be effected at once. Every time you turn the unit on, it will show its item number on the display and move all the motors to their 'home' position and you may hear some noises for about 20 seconds. After that the unit will be ready to receive DMX signal or run the built in programs.

5.1 Master/Slave Built In Preprogrammed Function

By linking the units in master/slave connection, the first unit will control the other units to give an automatic, sound activated, synchronized light show. This function is good when you want an instant show. Its DMX input jack will have nothing plugged into it, and Its master LED will be constantly on and sound LED will flash to the music. The other units will have to set in slave mode S L d and select S L 1 (normal) or S L 2 (2 light show) mode S L 3 (3 light show) mode or S L 4 (4 light show), Their DMX cables plugged into the DMX input jacks (daisy chain) and the slave led lights will constantly on.

S L 3 and S L 4 only for color-change.

2-light show

In S L d (slave mode), S L 1 means the unit works normally and S L 2 means 2-light show. In order to create a great light show, you can set S L 2 on the second unit to get contrast movement to each other, even if you have two units only.