

LVS-800

VIDEO MIX/LIVE SWITCHER

Owner's Manual

Before using this unit, carefully read the sections entitled: "USING THE UNIT SAFELY" and "IMPORTANT NOTES" (Owner's Manual p. 3-4; p. 5). These sections provide important information concerning the proper operation of the unit. Additionally, in order to feel assured that you have gained a good grasp of every feature provided by your new unit, Owner's Manual should be read in its entirety. The manual should be saved and kept on hand as a convenient reference.



Copyright © 2009 ROLAND CORPORATION

All rights reserved. No part of this publication may be reproduced in any form without the written permission of ROLAND CORPORATION.

For the U.K.

IMPORTANT: THE WIRES IN THIS MAINS LEAD ARE COLOURED IN ACCORDANCE WITH THE FOLLOWING CODE.

BLUE: NEUTRAL
BROWN: LIVE

As the colours of the wires in the mains lead of this apparatus may not correspond with the coloured markings identifying the terminals in your plug, proceed as follows:

The wire which is coloured BLUE must be connected to the terminal which is marked with the letter N or coloured BLACK.
The wire which is coloured BROWN must be connected to the terminal which is marked with the letter L or coloured RED.
Under no circumstances must either of the above wires be connected to the earth terminal of a three pin plug.



USING THE UNIT SAFELY

INSTRUCTIONS FOR THE PREVENTION OF FIRE, ELECTRIC SHOCK, OR INJURY TO PERSONS

About ⚠ WARNING and ⚠ CAUTION Notices





⚠ WARNING	Used for instructions intended to alert the user to the risk of death or severe injury should the unit be used improperly.
⚠ CAUTION	Used for instructions intended to alert the user to the risk of injury or material damage should the unit be used improperly. * Material damage refers to damage or other adverse effects caused with respect to the home and all its furnishings, as well to domestic animals or pets.

About the Symbols





	The ⚠ symbol alerts the user to important instructions or warnings. The specific meaning of the symbol is determined by the design contained within the triangle. In the case of the symbol at left, it is used for
	The ⓧ symbol alerts the user to items that must never be carried out (are forbidden). The specific thing that must not be done is indicated by the design contained within the circle. In the case of the symbol at left, it means that the unit must never be disassembled.
	The ⚡ symbol alerts the user to things that must be carried out. The specific thing that must be done is indicated by the design contained within the circle. In the case of the symbol at left, it means that the power-cord plug must be unplugged from the outlet.

ALWAYS OBSERVE THE FOLLOWING

⚠ WARNING





- Do not open (or modify in any way) the unit or its AC adaptor. 
- Do not attempt to repair the unit, or replace parts within it (except when this manual provides specific instructions directing you to do so). Refer all servicing to your retailer, the nearest Roland Service Center, or an authorized Roland distributor, as listed on the "Information" page. 
- Never install the unit in any of the following locations. 
 - Subject to temperature extremes (e.g., direct sunlight in an enclosed vehicle, near a heating duct, on top of heat-generating equipment); or are 
 - Damp (e.g., baths, washrooms, on wet floors); or are
 - Exposed to steam or smoke; or are
 - Subject to salt exposure; or are
 - Humid; or are
 - Exposed to rain; or are
 - Dusty or sandy; or are
 - Subject to high levels of vibration and shakiness.
- Make sure you always have the unit placed so it is level and sure to remain stable. Never place it on stands that could wobble, or on inclined surfaces. 

⚠ WARNING











- Be sure to use only the AC adaptor supplied with the unit. Also, make sure the line voltage at the installation matches the input voltage specified on the AC adaptor's body. Other AC adaptors may use a different polarity, or be designed for a different voltage, so their use could result in damage, malfunction, or electric shock. 
- Use only the attached power-supply cord. Also, the supplied power cord must not be used with any other device. 
- Do not excessively twist or bend the power cord, nor place heavy objects on it. Doing so can damage the cord, producing severed elements and short circuits. Damaged cords are fire and shock hazards! 
- Do not allow any objects (e.g., flammable material, coins, pins); or liquids of any kind (water, soft drinks, etc.) to penetrate the unit. 

USING THE UNIT SAFELY

WARNING

- Immediately turn the power off, remove the AC adaptor from the outlet, and request servicing by your retailer, the nearest Roland Service Center, or an authorized Roland distributor, as listed on the “Information” page when:
 - The AC adaptor, the power-supply cord, or the plug has been damaged; or
 - If smoke or unusual odor occurs
 - Objects have fallen into, or liquid has been spilled onto the unit; or
 - The unit has been exposed to rain (or otherwise has become wet); or
 - The unit does not appear to operate normally or exhibits a marked change in performance.
- In households with small children, an adult should provide supervision until the child is capable of following all the rules essential for the safe operation of the unit.
- Protect the unit from strong impact. (Do not drop it!)
- Do not force the unit’s power-supply cord to share an outlet with an unreasonable number of other devices. Be especially careful when using extension cords—the total power used by all devices you have connected to the extension cord’s outlet must never exceed the power rating (watts/amperes) for the extension cord. Excessive loads can cause the insulation on the cord to heat up and eventually melt through.
- Before using the unit in a foreign country, consult with your retailer, the nearest Roland Service Center, or an authorized Roland distributor, as listed on the “Information” page.

CAUTION

- The unit and the AC adaptor should be located so their location or position does not interfere with their proper ventilation.
- Always grasp only the plug on the power-supply cord when plugging into, or unplugging from, an outlet or this unit.
- At regular intervals, you should unplug the AC adaptor and clean it by using a dry cloth to wipe all dust and other accumulations away from its prongs. Also, disconnect the power plug from the power outlet whenever the unit is to remain unused for an extended period of time. Any accumulation of dust between the power plug and the power outlet can result in poor insulation and lead to fire.
- Try to prevent cords and cables from becoming entangled. Also, all cords and cables should be placed so they are out of the reach of children.
- Never climb on top of, nor place heavy objects on the unit.
- Never handle the AC adaptor or its plugs with wet hands when plugging into, or unplugging from, an outlet or this unit.
- Before moving the unit, disconnect the AC adaptor and all cords coming from external devices.
- Before cleaning the unit, turn off the power and unplug the AC adaptor from the outlet.
- Whenever you suspect the possibility of lightning in your area, disconnect the AC adaptor from the outlet.
- Keep any screws you may remove and the included plugs in a safe place out of children’s reach, so there is no chance of them being swallowed accidentally.

IMPORTANT NOTES

Power Supply

- Do not connect this unit to same electrical outlet that is being used by an electrical appliance that is controlled by an inverter (such as a refrigerator, washing machine, microwave oven, or air conditioner), or that contains a motor. Depending on the way in which the electrical appliance is used, power supply noise may cause this unit to malfunction or may produce audible noise. If it is not practical to use a separate electrical outlet, connect a power supply noise filter between this unit and the electrical outlet.
- The AC adaptor will begin to generate heat after long hours of consecutive use. This is normal, and is not a cause for concern.
- Before connecting this unit to other devices, turn off the power to all units. This will help prevent malfunctions and/or damage to other devices.

Placement

- This device may interfere with radio and television reception. Do not use this device in the vicinity of such receivers.
- Noise may be produced if wireless communications devices, such as cell phones, are operated in the vicinity of this unit. Such noise could occur when receiving or initiating a call, or while conversing. Should you experience such problems, you should relocate such wireless devices so they are at a greater distance from this unit, or switch them off.
- When moved from one location to another where the temperature and/or humidity is very different, water droplets (condensation) may form inside the unit. Damage or malfunction may result if you attempt to use the unit in this condition. Therefore, before using the unit, you must allow it to stand for several hours, until the condensation has completely evaporated.
- Depending on the material and temperature of the surface on which you place the unit, its rubber feet may discolor or mar the surface.
You can place a piece of felt or cloth under the rubber feet to prevent this from happening. If you do so, please make sure that the unit will not slip or move accidentally.

Maintenance

- For everyday cleaning wipe the unit with a soft, dry cloth or one that has been slightly dampened with water. To remove stubborn dirt, use a cloth impregnated with a mild, non-abrasive detergent. Afterwards, be sure to wipe the unit thoroughly with a soft, dry cloth.
- Never use benzine, thinners, alcohol or solvents of any kind, to avoid the possibility of discoloration and/or deformation.

Additional Precautions

- This unit allows you to switch images at high speed. For some people, viewing such images can cause headache, nausea, or other discomfort. Do not use this unit to create video that might cause these types of health problems. Roland Corporation will accept no responsibility for any such health problems that may occur in yourself or in viewers.
- Use a reasonable amount of care when using the unit's buttons, sliders, or other controls; and when using its jacks and connectors. Rough handling can lead to malfunctions.
- When connecting / disconnecting all cables, grasp the connector itself—never pull on the cable. This way you will avoid causing shorts, or damage to the cable's internal elements.
- When you need to transport the unit, package it in the box (including padding) that it came in, if possible. Otherwise, you will need to use equivalent packaging materials.
- Security Slot ()
<http://www.kensington.com/>

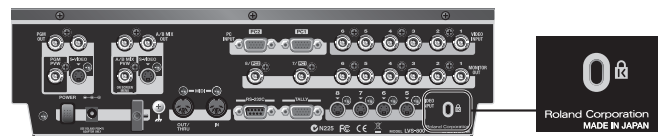

Contents

Check the included items	7
Names of Things and What They Do	8
Top Panel.....	8
Rear Panel.....	10
Connecting Peripheral Devices	11
Connecting Source Devices.....	11
Connecting Video Devices.....	11
Connecting Computers.....	11
Connecting Output Devices.....	12
The Difference Between A/B MIX OUT and PGM OUT.....	12
Connecting Output Devices.....	13
TALLY Output.....	13
Turning the Power On/Off	14
Connecting the AC adaptor.....	14
Turning the power on.....	15
Switching Between A Bus and B Bus	16
Switching the Picture in the A/B Mode.....	16
Switching the Picture Using the Video Fader.....	16
Switching Using the AUTO Button.....	18
Use in Other Operation Modes Besides the A/B Mode.....	19
Changing the Operation Mode.....	19
Switching After Monitoring the Preview Picture (PGM-PST Mode).....	20
Switching the Picture Directly (LVS Mode).....	21
Using Picture-in-Picture to Composite Two Screens.....	22
Composition in the A/B Mode or LVS Mode.....	22
Composition in the PGM-PST Mode.....	24
Using the Downstream Keyer (DSK)	26
What's a Downstream Keyer (DSK)?.....	26
Trying Out DSK Composition.....	27
Combining DSK and Picture-in-Picture.....	29
Applying Fade to the Final Output	30
Saving Settings to PANEL PRESET Buttons	31
Saving the Current Settings.....	31
Calling Up Saved Settings.....	31
Copying Saved Settings to Another Button.....	32
Exchanging Saved Settings with Another Button.....	33
Returning to Factory-default State (Factory Reset)	34
Switching Between NTSC and PAL	35
Changing Settings Using the Menus	36
Displaying the Menus.....	36
Menu Levels.....	36
Menu Operations.....	37
Menu List	38
Troubleshooting	44
Main Specifications	46
Remote Control.....	46
Index	47

Check the included items

The following items are included. Please make sure that all items are present. If anything is missing, please contact your dealer.

LVS-800 itself



AC Adaptor (PSB-7U) and Power Cord



RCA-BNC adaptor plugs (four)



Owner's Manual (this document)

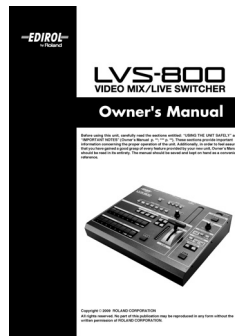

Names of Things and What They Do

Top Panel

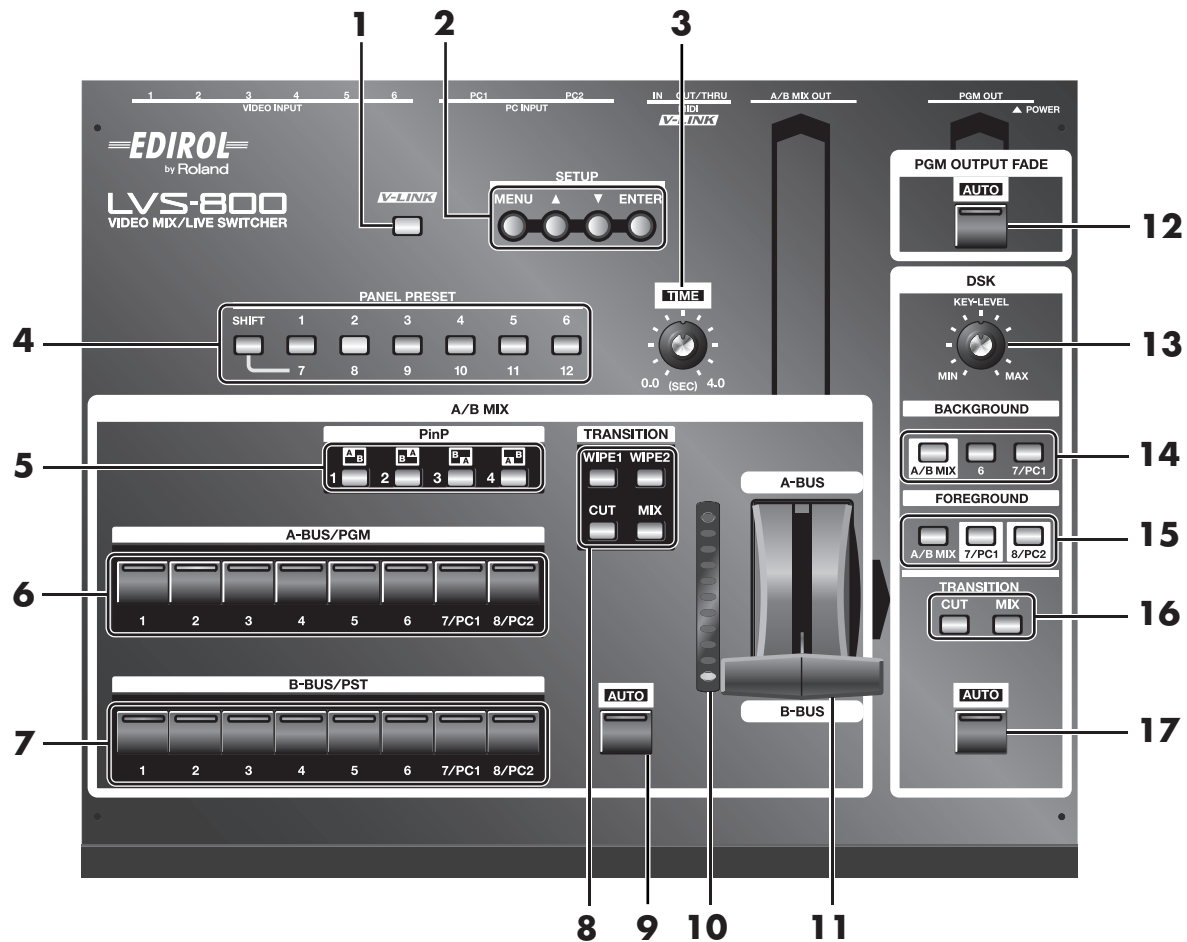

1. V-LINK Button

This allows connection of V-LINK-compatible equipment from Roland. To operate the RSS-V-Mixer by remote control, press this button to switch it on.

What's V-LINK?

V-LINK is a feature for performing video synchronized to music using MIDI. The V-LINK feature provides a quick and simple way to establish a link with a Roland instrument, music-production device, or video presenter.

MEMO

During remote control of a V-LINK-compatible instrument, music-production device, or video equipment via a MIDI connection, this button lights up automatically when V-LINK is switched on at the connected device.

MEMO

For more information about remote control via MIDI, V-LINK, or the RS-232C interface, please download the separately available reference document from the following Roland website.

<http://www.rolandsystemsgroup.net/>

2. SETUP Buttons (p. 36)

These are used for such tasks as displaying various menu items and making system settings.

3. TIME Dial

This sets the transition time when performing a switch using the AUTO button. It makes the following three AUTO-button time settings.

- For A/B MIX
- For DSK
- For PGM OUTPUT FADE

4. PANEL PRESET Buttons (p. 31)

These save the current panel settings. Use them to instantly call up saved panel settings.

5. PinP Buttons (p. 22)

These are used for Picture-in-Picture composition of the A Bus video and B Bus video.

6. A Bus/PGM Input Selectors (p. 16)

These select the video to input to A Bus.

**During use in the PGM-PST mode, you use these to select the video channel for program output.*

7. B Bus/PST Input Selectors (p. 16)

These select the video to input to B Bus.

**During use in the PGM-PST mode, you use these to select the video for preview output.*

8. TRANSITION Buttons for A/B MIX (p. 16)

These select the transition effect used during a transition between A Bus and B Bus.

9. AUTO Button for A/B MIX (p. 18)

This performs a transition between A Bus and B Bus by button operation, without using the video fader. It flashes during the transition operation. When the transition ends, it goes dark.

10. TRANSITION Indicator

This displays the location of the video fader. The lighted location is changed by operation of the video fader or the AUTO button for A/B MIX. Illumination of more elements toward the front of the unit indicates a greater ratio of B Bus video. Illumination of more elements toward the back of the unit indicates a greater ratio of A Bus video.

11. Video Fader (p. 17)

This is a T-bar type video fader. You switch between A Bus and B Bus by moving it up and down.

12. PGM OUTPUT FADE Button (p. 30)

Operating this button automatically applies a fade-in or fade-out to program output. The time of the fade-in or fade-out is set using the TIME dial. This lights up when a fade-out has been completed. It goes dark when a fade-in has been completed and program video is being output. It flashes while a fade is in progress.

13. KEY LEVEL Dial (p. 28)

This adjusts the degree of the key composition.

14. BACKGROUND Buttons (p. 27)

These select the DSK background picture.

15. FOREGROUND Buttons (p. 27)

These select the DSK foreground picture.

16. TRANSITION Buttons for DSK (p. 27)

These select how the picture set for the foreground to appear and disappear.

17. AUTO Button for DSK (p. 28)

This displays the picture set for the foreground. It lights up when the foreground picture is output. It goes dark when the picture is not output. It flashes while a mix is in progress.

Rear Panel

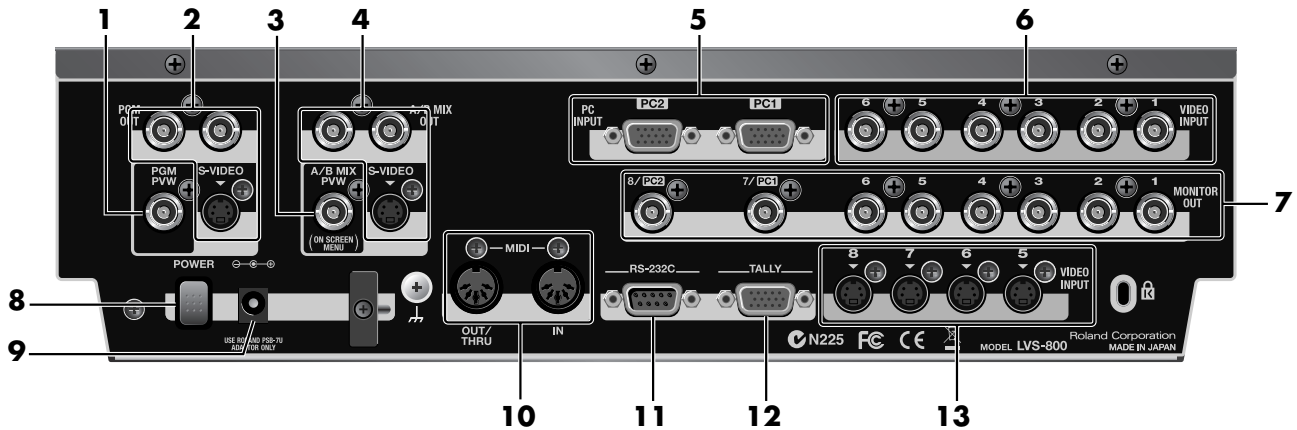

1. PGM PVW Connector

This outputs the DSK preview picture. Before performing DSK composition, you connect a monitor to check and verify the video displayed as the DSK foreground. You can then composite the background picture after first checking the logos, text, or other images.

2. PGM OUT Connectors

These output the mixed video plus the DSK composition. You connect them to projectors or other display equipment for the final output.

Two composite connectors and one S-Video connector are available. All connectors output the same picture.

3. A/B MIX PVW Connector

This outputs a preview picture for the video mix. You connect a monitor for previewing a source prior to committing to a transition. The current location of the video fader and the selected video on the inactive bus are output.

A variety of setting menus are also displayed at the top of the preview picture.

4. A/B MIX OUT Connectors

These output only the mix results for A Bus and B Bus. You can connect a video deck or other such recording unit and record the video prior to DSK composition.

Two composite connectors and one S-Video connector are available. All connectors output the same picture.

5. PC INPUT Connectors

These are for RGB-signal input. You can connect computers that serve as video source.

**Incoming computer signal will be downscaled to match the resolution of other video sources.*

6. VIDEO INPUT (Composite) Connectors

These are for composite-signal input. You can connect cameras or other video sources.

7. MONITOR OUT Connectors

These output signals being input via the VIDEO INPUT connectors (composite or S-Video) without processing.

You can connect a monitor to each of these "loop-thru" monitor outputs.

8. POWER Button

This switches the power on and off.

9. AC Adapter Connector

This is for connecting the included AC adapter (PSB-7U).

10. MIDI IN and OUT/THRU Connectors

Use these when connecting a MIDI device (a V-LINK-compatible product or the like) to operate the unit remotely, or when using the unit to perform remote control of another device.

11. RS-232C Connector

Use this when connecting an external device to operate the unit remotely.

MEMO

For more information about remote control via MIDI, V-LINK, or RS-232C interface, please download the separately available reference materials from the following Roland website.
<http://www.rolandsystemsgroup.net/>

12. TALLY Connector

Provides low-current contact closure to activate tally lamps on your cameras or tally light system.

13. VIDEO INPUT (S-Video) Connectors

These are for input of S-Video signals. You can connect cameras or other video sources. When composite or RGB and S-Video signals are simultaneously input to the same channel, the S-Video signals take priority.

Connecting Peripheral Devices

Connecting Source Devices

To prevent malfunction or damage to video monitors or other devices, always turn off the power on all devices before making any connections.

Connecting Video Devices

Channels 1 through 4 are exclusively for composite signals. S-Video can be connected to channels 5 through 8. Channels 5 and 6 can be used either for composite or S-Video, but S-Video takes priority when both types of signals are input.

**When connecting a device that has an RCA pin type connector to a composite input connector, use the included adaptor plug.*

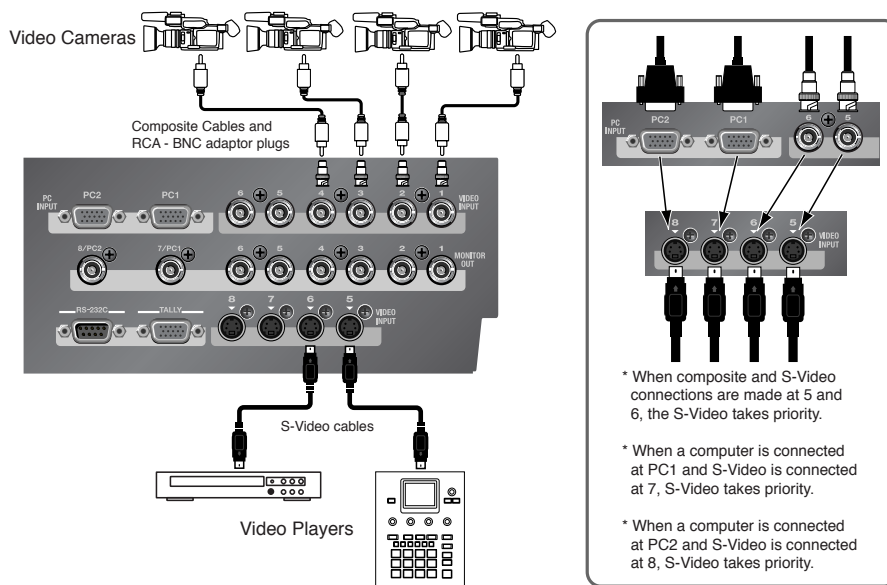

Connecting Computers

Computers can be connected at the PC1 and PC2 connectors. A built-in scan converter converts the incoming RGB signal to a standard definition video signal. Channels 7 and 8 can be used for both computer and S-Video input. When both types of signals are input, the S-Video takes priority.

**The PC1 and PC2 input connectors on the LVS-800 are for D-Sub 15-pin cables. Using a cable adapter makes it possible to connect devices that have DVI-I output connectors. A D-Sub 15-pin to DVI-I adapter is not included. Please purchase one separately.*

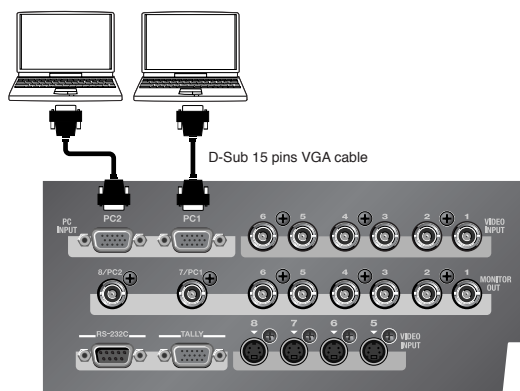

Supported Resolutions

640 x 480 / 120Hz	800 x 600 / 120Hz
832 x 624 / 75Hz	1024 x 768 / 80Hz
1152 x 864 / 75Hz	1152 x 870 / 75Hz
1280 x 1024 / 75Hz	1600 x 1200 / 60Hz

* The refresh rate is the maximum value of each resolution.

NOTE

When displaying a movie from computer input, flicker or other picture corruption may occur. This is called tearing, and does not indicate an equipment malfunction.

Connecting Peripheral Devices

Connecting Output Devices

The Difference Between A/B MIX OUT and PGM OUT

The LVS-800 is equipped with two sets of output connectors. These are the A/B MIX OUT connectors and the PGM OUT connectors. The A/B MIX OUT connectors output only the results of the mixed video of A Bus and B Bus (A/B MIX). The PGM OUT connectors output the results of the A/B mix plus your composited logos, text, etc (DSK composition). Final output fade is enabled only for PGM OUT.

**In the figure shown below, 1 through 4 indicate where on the panels the respective internal blocks are located.*

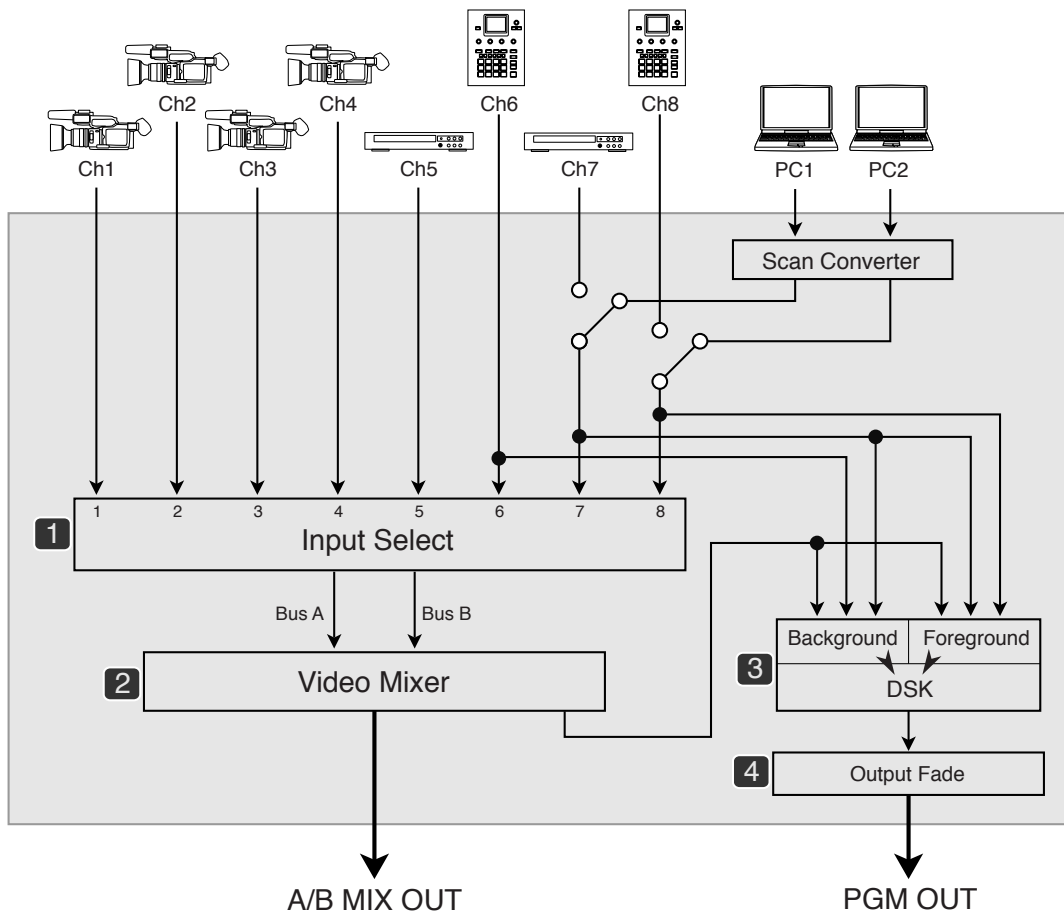

Connecting Output Devices

You can connect displays or capture devices to the A/B MIX OUT in order to view or capture the output of the A/B mix only (no DSK). You should connect displays or capture devices to the PGM OUT jacks in order to view or capture the final mix of A/B mix plus DSK. You can connect source monitors to the MONITOR OUT jacks to have at-a-glance monitoring of all your input sources. Monitors connected to the A/B MIX PVW or PGM PVW jacks will allow you to preview sources.

**When computers are connected to the PC1 and PC2 input connectors, the scan-converted video signals are output from the 7/PC1 and 8/PC2 output connectors.*

**The output from A/B MIX PVW displays on-screen menu items in addition to the video before transition.*

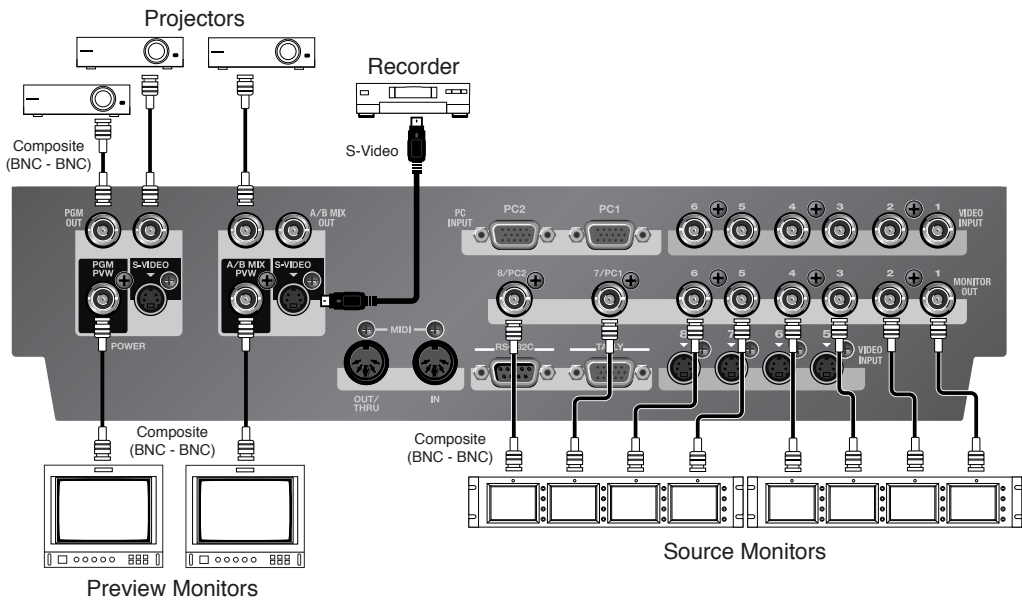

TALLY Output

The LVS-800 is equipped with a D-Sub 15-pin TALLY output connector. Connecting a video monitor capable of tally input to this makes it possible to illuminate the tally lamps on the monitor. The lamp is switched on and off according to the channel selection, enabling you to see which channel is currently in use on the monitor.

The pin assignment is as shown below. The LVS-800 uses an open-collector tally output (closed contact).

**Connecting a video monitor capable of tally input requires a cable that must be obtained separately.*

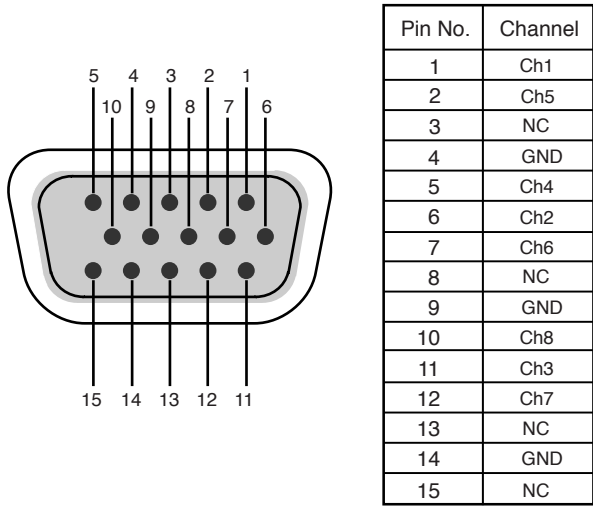

Turning the Power On/Off

Connecting the AC adaptor

Connect the AC adaptor to LVS-800. Place the AC adaptor so the side with the indicator (see illustration) faces upwards and the side with textual information faces downwards. The indicator will light when you plug the AC adaptor into an AC outlet.

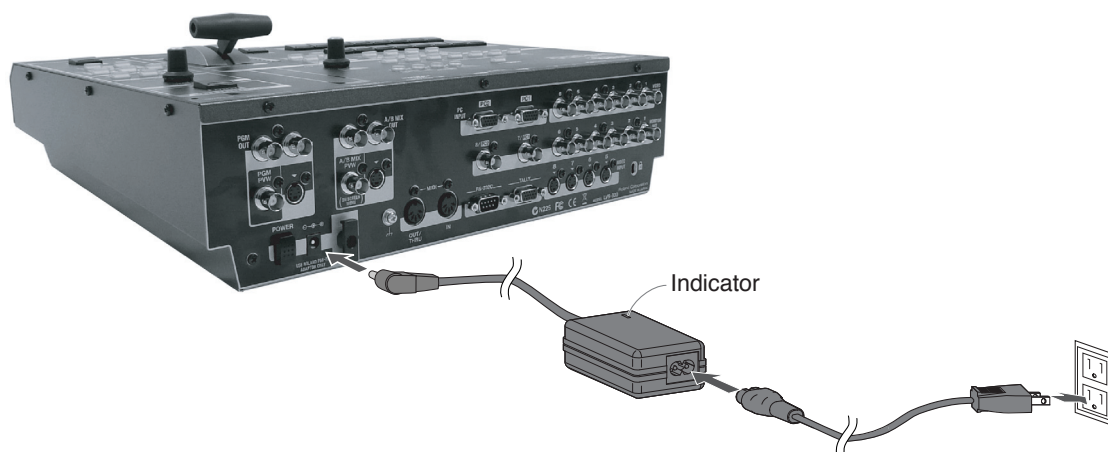

About Cord Hook

To prevent the inadvertent disruption of power to your unit (should the plug be pulled out accidentally), and to avoid applying undue stress to the AC adaptor connector, anchor the power cord using the cord hook, as shown in the illustration.

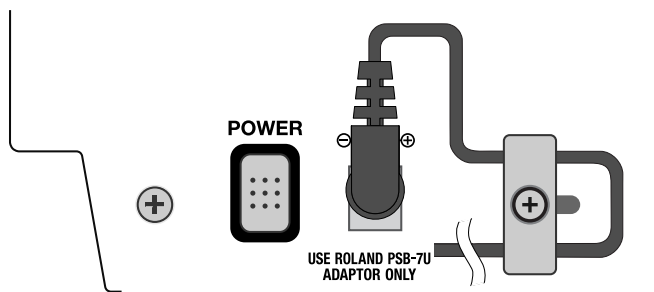

Caution regarding the power supply

Depending on the circumstances of a particular setup, you may experience a discomforting sensation, or perceive that the surface feels gritty to the touch when you touch this device, cameras connected to it, or the metal portions of other objects, such as VCRs. This is due to an infinitesimal electrical charge, which is absolutely harmless. However, if you are concerned about this, connect the ground terminal (see figure) with an external ground. When the unit is grounded, a slight noise may occur, depending on the particulars of your installation. If you are unsure of the connection method, contact the nearest Roland Service Center, or an authorized Roland distributor, as listed on the "Information" page.

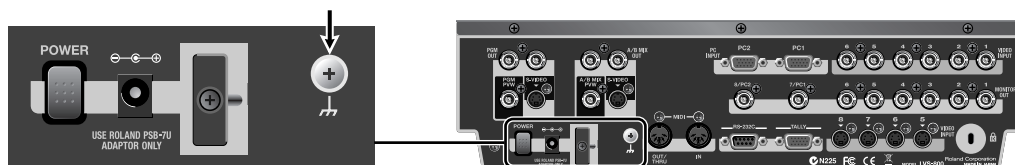

Unsuitable places for connection

- Water pipes (may result in shock or electrocution)
- Gas pipes (may result in fire or explosion)
- Telephone-line ground or lightning rod (may be dangerous in the event of lightning)

Turning the power on

**Once the connections have been completed (p. 14), turn on power to your various devices in the order specified. By turning on devices in the wrong order, you risk causing malfunction and/or damage to monitors and other devices.*

**This unit is equipped with a protection circuit. A brief interval (a few seconds) after power up is required before the unit will operate normally.*

Turning the power on

Make sure that the AC adaptor is correctly connected. Press the [POWER] button located on rear panel. It takes few seconds to boot the system.

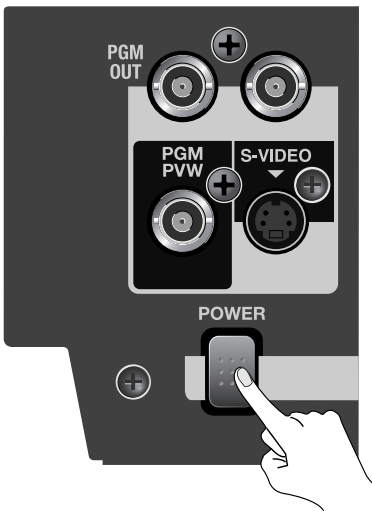

Turning the power off

Press the [POWER] button located on rear panel. Check all indicators/LEDs to turn off.

Switching Between A Bus and B Bus

Input sources are selected and switched between the A Bus and the B Bus. The unit has eight input selectors for each Bus, and you choose the input video for each bus before you perform the transition.

With the LVS-800, you can switch between A Bus and B Bus in three different modes. Operation of each of these modes is described below.

- A/B mode This performs switching using the video fader or the [AUTO] button for A/B MIX.
- PGM-PST mode This lets you check the preview picture before switching and perform the transition using the [AUTO] button.
- LVS mode This lets you perform switching directly, using only the input selector buttons.

The results of these operations are output from the A/B MIX OUT connectors. If you want to output the results from the PGM OUT connectors as well, make the settings described below.

- At [PGM OUTPUT FADE], switch off the [AUTO] button.
- At DSK, for [BACKGROUND], select [A/B MIX].
- Switch off the [AUTO] button for DSK.

Switching the Picture in the A/B Mode

Switching the Picture Using the Video Fader

1. Choose the A Bus and B Bus video.

Select the channels of the video input to A Bus and B Bus. Selecting an input channel makes the LED for the button light up. For information about what the color of the LED means, see the following page.

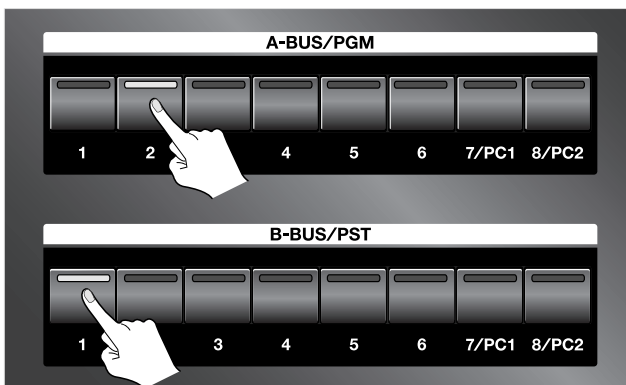

2. Choose the type of transition (transition effect).

If you want to apply a transition effect, use a [TRANSITION] button to choose [MIX], [WIPE1], or [WIPE2]. To apply no effect, choose [CUT].

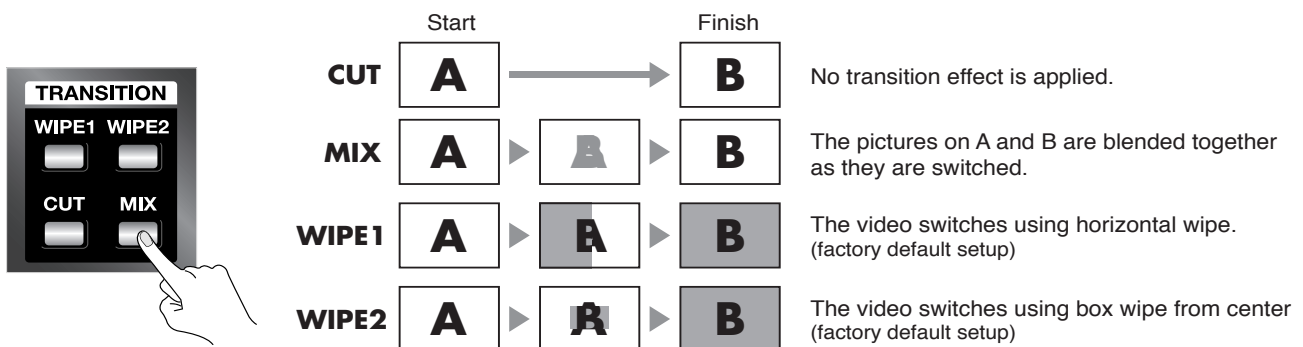

Switching Between A Bus and B Bus

3. Move the video fader.

Move the video fader. Moving it toward the back of the unit makes more of the picture on A Bus appear, and moving toward the front displays more B Bus picture.

**If you selected [CUT] in step 2, the picture is switched between A Bus and B Bus at the middle position of the video fader.*

**When the same input channel has been selected for A Bus and B Bus, moving the video fader does not affect the output.*

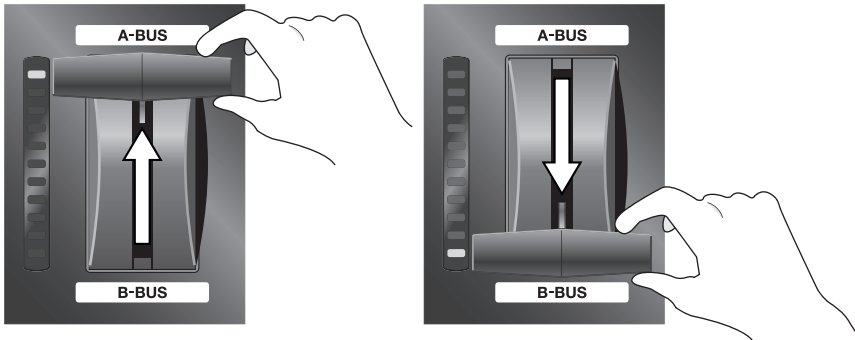

NOTE

When the video fader has not been moved all the way to the A Bus or B Bus side, changing the input channel for the opposite bus may cause noise on the output picture. When changing the input channel for the bus on the side opposite the bus displayed, first make sure that the video fader has been moved all the way to the end of the stroke.

The LEDs of the Input Selector Buttons

Pressing an input selector button for A Bus or B Bus makes the button's LED light up. The color of the LED may change to red or green, depending on the position of the video fader. The LED at the end of the stroke to which the video fader has been moved completely (100% output) lights up in red, and the LED at the opposite end of the stroke (corresponding to the channel now in standby and providing no output at all) lights up in green. When the control is not completely at one of these ends, and both buses are producing output, both LEDs light up in red.

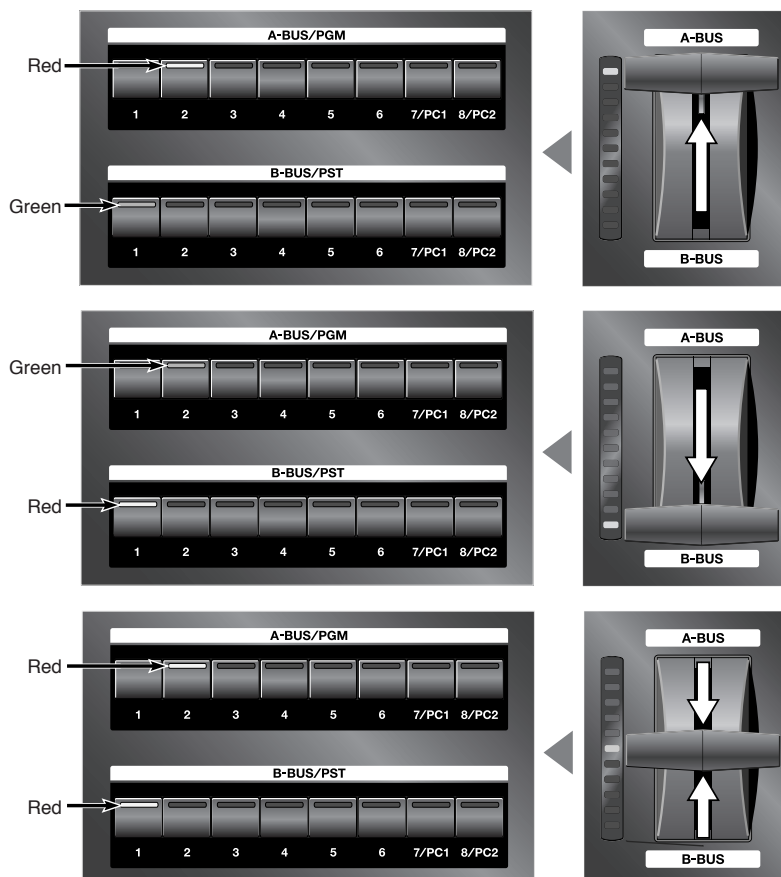

Switching Between A Bus and B Bus

Switching Using the AUTO Button

You can also perform switching simply by pressing the [AUTO] button for A/B MIX, without using the video fader. The video fader itself does not move, but movement between A and B is performed automatically. The location of the light on the TRANSITION indicator shows the movement between A and B.

1. Choose the type of transition (transition effect).

If you want to apply a transition effect, use a [TRANSITION] button to choose [MIX], [WIPE1], or [WIPE2]. To apply no effect, choose [CUT].

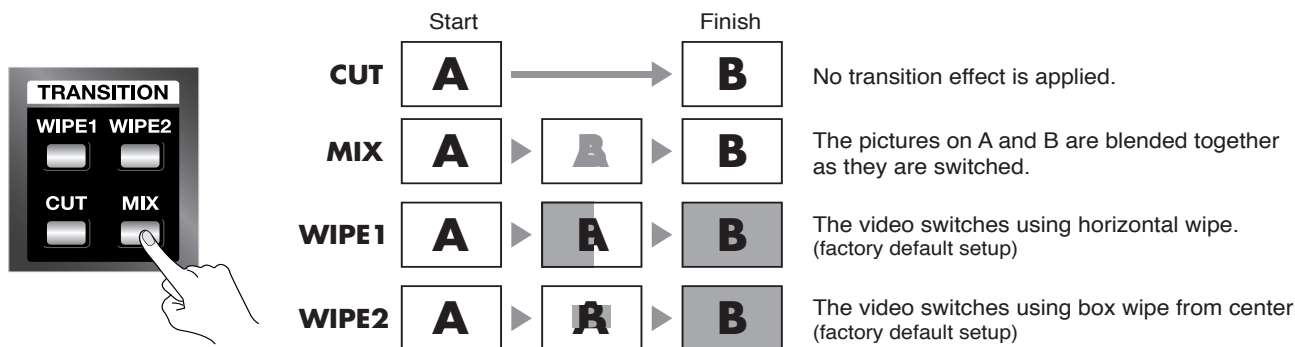

2. Set the transition time.

Turn the [TIME] dial to set the transition time. You can set this anywhere within the range of 0 (zero) to 4 seconds. You can set the transition time at any point along a stepless range.

**If you selected [CUT] in step 1, the time setting has no effect.*

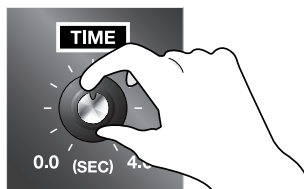

3. Perform the transition.

Press the [AUTO] button. The TRANSITION indicator shows the shift between A and B.

**When the same input channel has been selected for both A Bus and B Bus, no transition in the video occurs when the button is pressed.*

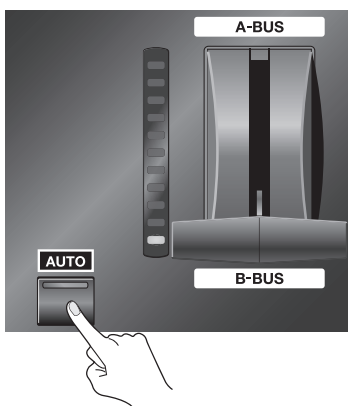

NOTE

When a transition has been made using the [AUTO] button, the position of the video fader does not match the lighted location of the TRANSITION indicator. Pulling the video fader back all the way toward the front may result in the indicator lighting up at the A Bus side.

A Bus is output in this status. To restore the original relation, move the video fader forward and backward all the way.

Use in Other Operation Modes Besides the A/B Mode

Changing the Operation Mode

Changing the operation mode is accomplished using the menus. For more information about how to do this, refer to “Changing Settings Using the Menu” (p. 36).

**The on-screen menu will only appear on a monitor connected to the A/B MIX PVW jack.*

1. From the menu, select “Panel Mode Setup.”

Press the [MENU] button to display the menu screen. From the list that appears, choose “Panel Mode Setup,” then press the [ENTER] button.



2. Choose “PGM-PST Mode” or “LVS Mode.”

- PGM-PST mode This lets you use the [AUTO] button for A/B MIX to execute a transition after checking the preview video.
- LVS mode This lets you perform a transition directly using the input selector buttons.

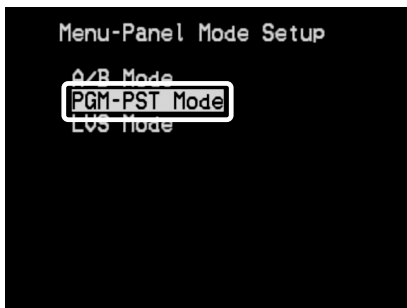

3. End the menu display.

Press the [MENU] button several times to make the menu display disappear.

The Names of the Buses in the PGM-PST Mode

When the operation mode is changed to the PGM-PST mode, the names of the buses also change. “A” becomes “PGM,” and “B” becomes “PST.”

Switching Between A Bus and B Bus

Switching After Monitoring the Preview Picture (PGM-PST Mode)

In the PGM-PST mode, before you perform a switch, you can check the video on the preview monitor, then use the buttons to execute the transition. The preview picture is displayed on the preview monitor connected to the A/B MIX PVW connector.

1. Choose the type of transition (transition effect).

If you want to apply a transition effect, use a [TRANSITION] button to choose [MIX], [WIPE1], or [WIPE2]. To apply no effect, choose [CUT].

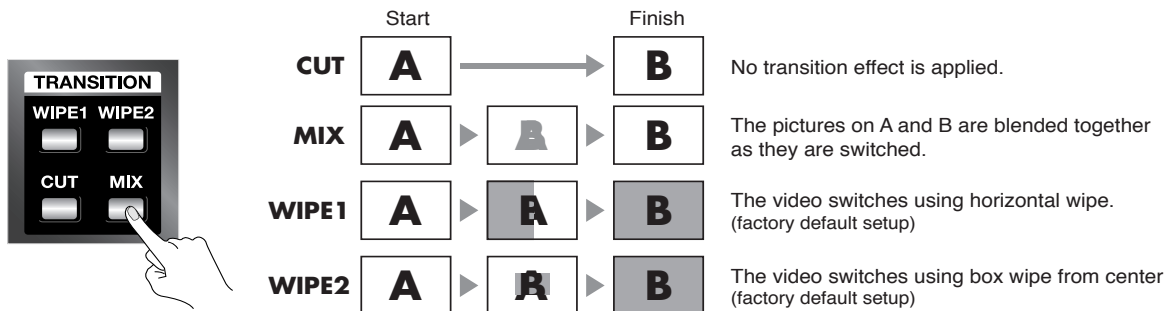

2. Set the transition time.

Turn the [TIME] dial to set the transition time. You can set this anywhere within the range of 0 (zero) to 4 seconds. You can set the transition time at any point along a stepless range.

**If you selected [CUT] in step 1, the time setting has no effect.*



3. Choose the video channel on the PST side.

The picture on the selected channel is output to the preview monitor connected to the A/B MIX PVW connector. The selected video is not output to A/B MIX OUT or PGM OUT at this stage.

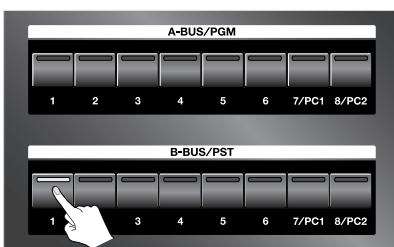

4. Output the video.

Press the [AUTO] button for A/B MIX. The video you selected in step 3 is output from the A/B MIX OUT and PGM OUT connectors. As this happens, the corresponding input LED is lit on the PGM Bus to indicate that the selected input is now active. PGM Bus will always indicate the currently active input being sent to the PGM outputs. In the PGM-PST mode, the TRANSITION indicator and the button LEDs work as shown below.

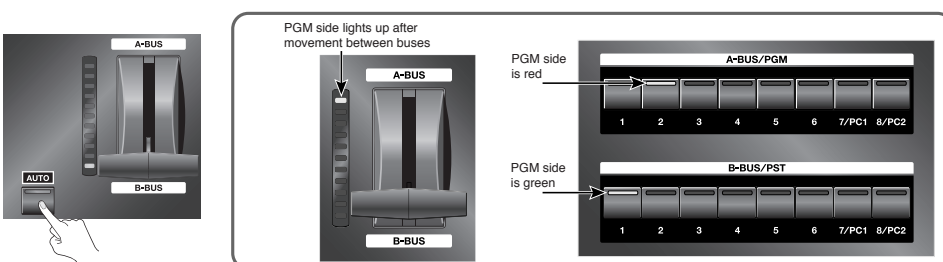

Switching the Picture Directly (LVS Mode)

When no previewing is needed, you can perform switching by using only the input selector buttons. This lets you execute a transition more easily and rapidly. You can do this in the LVS mode.

MEMO

In the LVS mode, B Bus is handled as main video and A Bus is handled as insert video. Moving the video fader to the A Bus side superimposes the insert video selected on A Bus over the main video of B Bus. P in P (Picture-in-Picture) settings are also enabled.

MEMO

The video selected for A Bus is output from the A/B MIX PVW connector.

1. Move the video fader to the B Bus side.

2. Select the input channel.

Press the B Bus input selector buttons in succession to switch the video.

**The transition-effect and transition-time settings remain in effect for switching performed in this way. Also note that no channel can be selected for A Bus while a transition effect is being applied.*

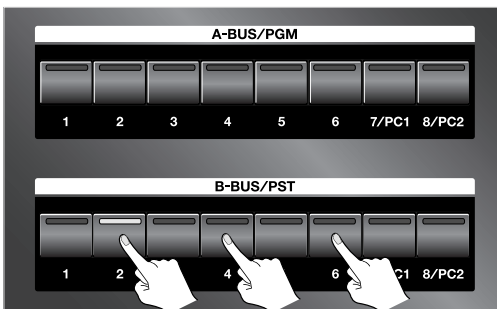

NOTE

When the LVS mode is enabled and the video fader is set to A Bus, using the B Bus input selector buttons to switch the channel makes the output video change in the sequence shown below.

1. Selected channel on A Bus

2. Previously selected channel on B Bus

3. Newly selected channel on B Bus

**At step 2, the picture is displayed briefly, then immediately changes to 3.*

**Between 1 and 2, the transition-effect and transition-time settings have no effect.*

**between 2 and 3, the transition-effect and transition-time settings are applied.*

Let's say that you have selected input 2 on A Bus and input 1 on B Bus, and the video fader is set to A Bus. In this state, the video for input 2 is output. If you now change the selected channel for B Bus from input 1 to input 3, the output picture changes in the sequence shown below.

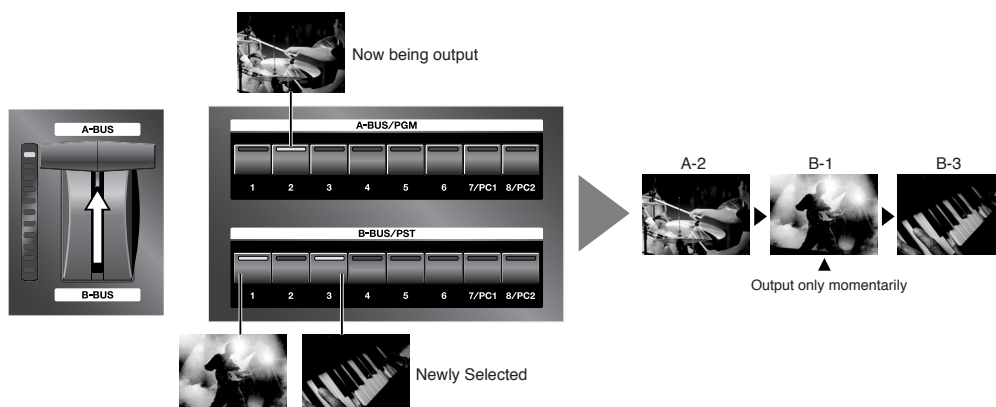

Switching Between A Bus and B Bus

Using Picture-in-Picture to Composite Two Screens

You can apply Picture-in-Picture to create a small window of one source superimposed over another source.

Composition in the A/B Mode or LVS Mode

The A Bus video is the inset screen, and is displayed over the B Bus video (the background).

1. Choose the picture to display in the inset screen.

Choose the channel of the video to display in the inset screen on A Bus.

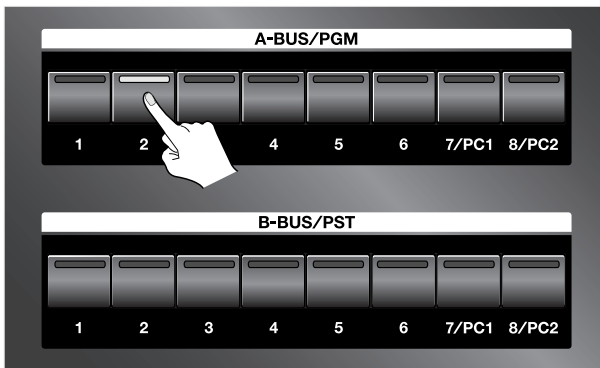

2. Choose the picture to make the background.

Choose the channel of the video for the background on B Bus.

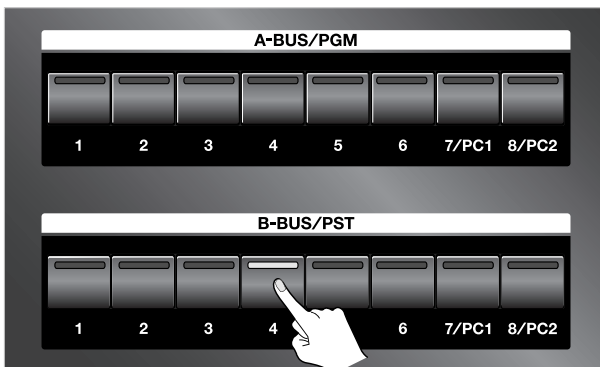

3. Press a [P in P] button.

Press any of the four [PinP] buttons. The location where the inset screen is displayed varies depending on the button you press.

The [A] in the square on the panel indicates the location of the inset screen.

MEMO

Pressing the illuminated [PinP] button a second time cancels the selection and makes the button go dark. The picture on the inset screen displayed changes to a full-screen display.

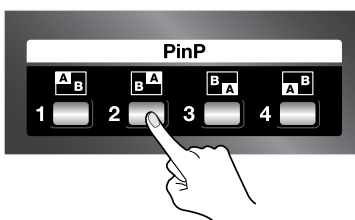

4. Move the video fader to the A Bus (inset screen) side.

Move the video fader to the A Bus side. The inset screen appears.

**The way the inset screen comes into view differs according to the transition-effect setting. When [CUT] has been selected, it remains hidden until the middle position is reached, and is displayed thereafter.*

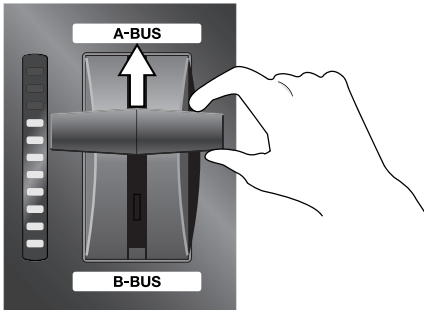

5. Move the video fader to the B Bus (background) side.

Move the video fader to the B Bus side. The inset screen disappears.

**The way the inset screen disappears from view differs according to the transition-effect setting.*

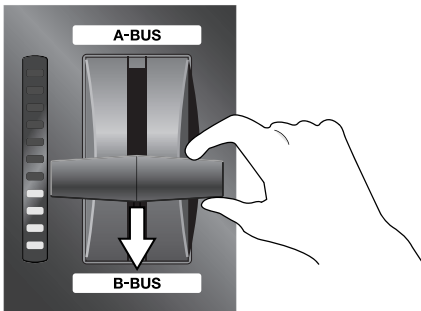

TIP

You can apply Picture-in-Picture by using the [AUTO] button for A/B MIX, without operating the video fader.

TIP

You can also change where the inset screen is displayed while Picture-in-Picture is being applied. Pressing a different [P in P] button from the one you chose in step 3 changes the display location.

NOTE

In the LVS mode, using a B Bus input selector to change the background picture during display of an inset screen makes the displayed inset screen disappear. If this happens, move the video fader to the B Bus side, then move it back to the A Bus side. Returning it to the A Bus side makes the inset screen reappear.

In the A/B mode, changing the background does not make the displayed inset screen disappear.

NOTE

The only transition effects available for selection during Picture-in-Picture composition are [MIX] and [CUT]. Selecting [WIPE1] or [WIPE2] is not possible.

Switching Between A Bus and B Bus

Composition in the PGM-PST Mode

You can use Preview to check the video for inset-screen display first, then display it using the [AUTO] button.

1. Choose the background channel.

Choose the channel of the video to display as the background with PST.

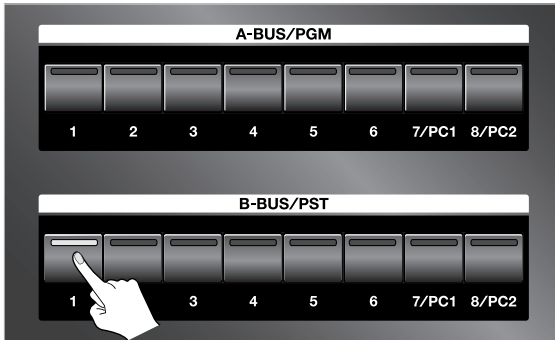

2. Display the background.

Press the [AUTO] button to display the background video.

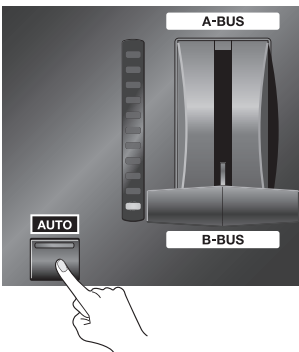

3. Check the picture of the inset screen.

Choose the channel of the video to display in the inset screen with PST. The selected picture is output to the preview monitor connected to the A/B MIX PVW connector.

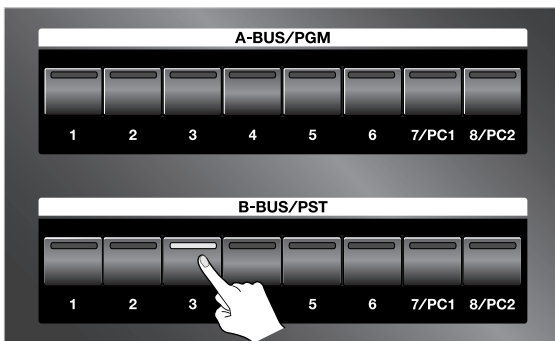

4. Press a [P in P] button.

Press any of the four [PinP] buttons. The location where the inset screen is displayed varies depending on the button you press. The [A] in the square on the panel indicates the location of the inset screen.

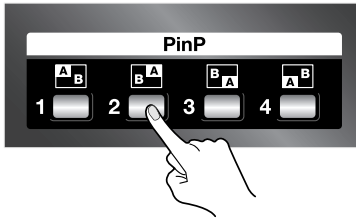

5. Display the inset screen.

Press the [AUTO] button for A/B MIX to composite the inset-screen picture on the background. The results of composition are output to a recording unit or projector connected to a A/B MIX OUT connector.

**The way the inset screen comes into view differs according to the transition-effect setting. When [CUT] has been selected, it appears instantly when the [AUTO] button for A/B MIX is pressed.*

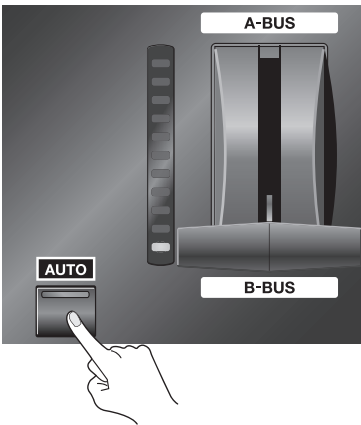

6. Make the inset screen disappear.

Press the [AUTO] button for A/B MIX to make the inset-screen picture disappear.

**The way the inset screen disappears from view differs according to the transition-effect setting. When [CUT] has been selected, it disappears instantly when the [AUTO] button for A/B MIX is pressed.*

TIP

You can also change where the inset screen is displayed while Picture-in-Picture is being applied. Pressing a different [PinP] button from the one you chose in step 3 changes the display location.

Using the Downstream Keyer (DSK)

What's a Downstream Keyer (DSK)?

A Downstream Keyer (DSK) allows you to superimpose text or graphics over background video. Since the text or graphics appear "downstream" from your A/B mix, you can freely switch or mix various video sources behind your "keyed" text or graphics.

Generally, elements such as logos and text are composited using DSK. This feature makes it possible to switch the background video or actuate picture-in-picture while displaying same logos or text in the foreground.

NOTE

The results of DSK composition are output only via the PGM OUT connectors. No DSK output comes from the A/B MIX OUT connectors.

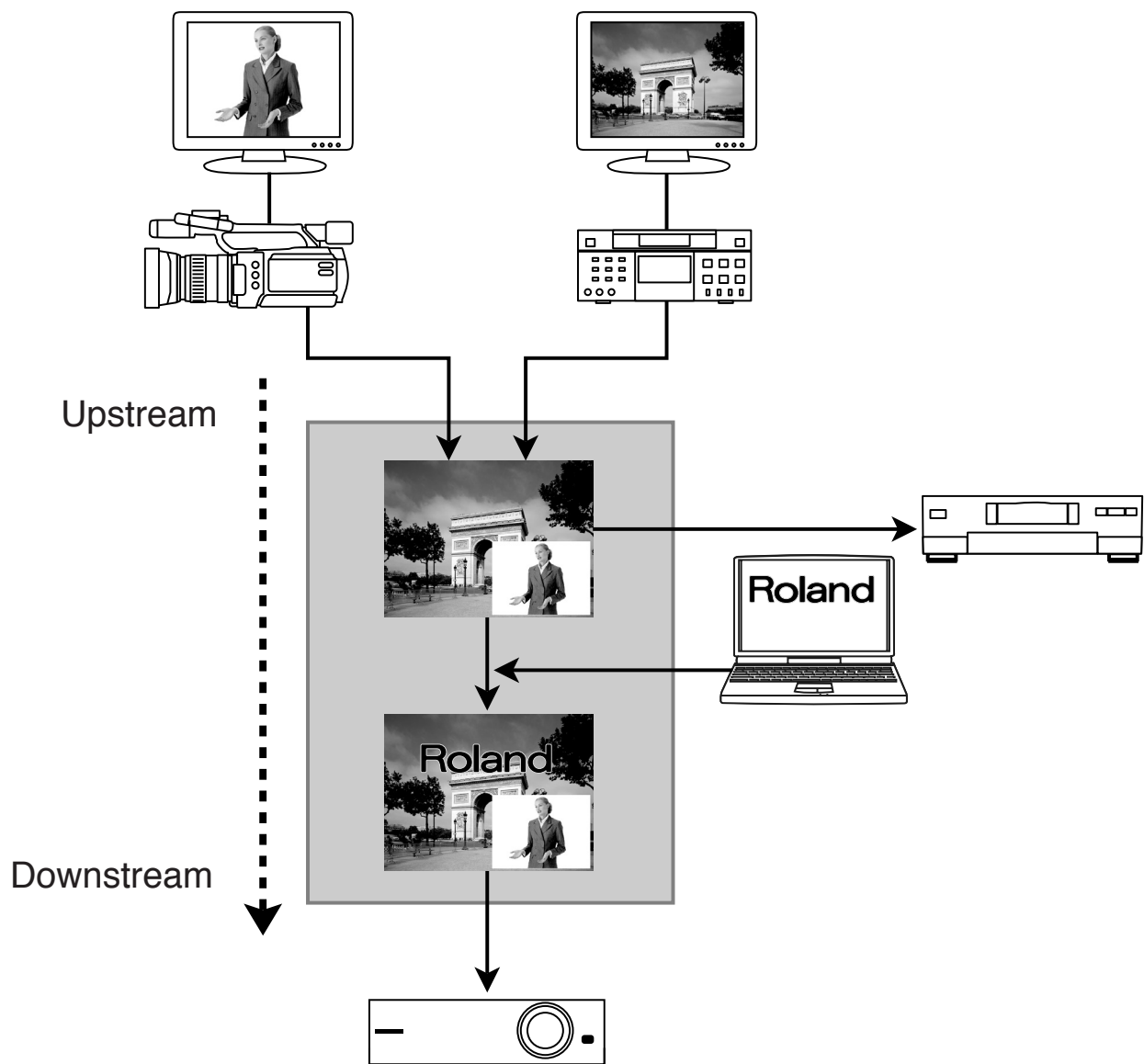

Trying Out DSK Composition

1. Choose the background picture.

Use the three BACKGROUND buttons to choose the background video. If you want to use the results of the A/B mix as the background, press the [A/B MIX] button to make it light up. If you want to use source video directly from channel 6 or channel 7 as the background, choose [6] or [7/PC1].

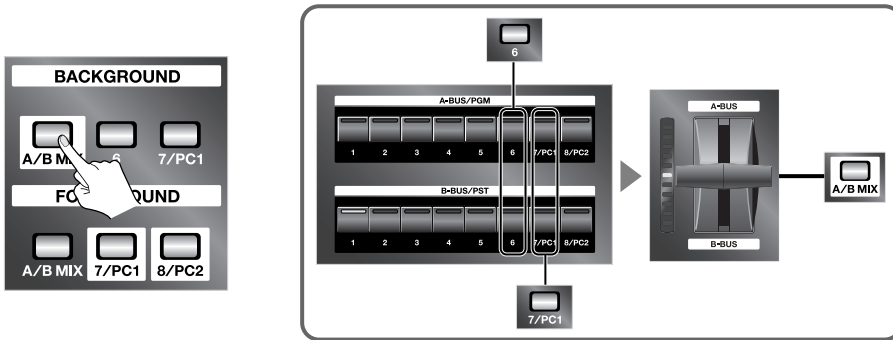

2. Choose the foreground picture.

Use the three FOREGROUND buttons to choose the video you want to composite and display on the foreground. If you want to composite a logo, text, or other such element from a computer, press either the [7/PC1] button or the [8/PC2] button to make it light up. The picture you selected using FOREGROUND is output to the preview monitor via the PGM PVW connector.

NOTE

Before you perform composition, check whether the picture from the computer is being output correctly to the LVS-800. Send the output from channels 7 or 8 to a monitor or projector, and check the picture. The output might not look correct if the proper settings have not been made on the computer.

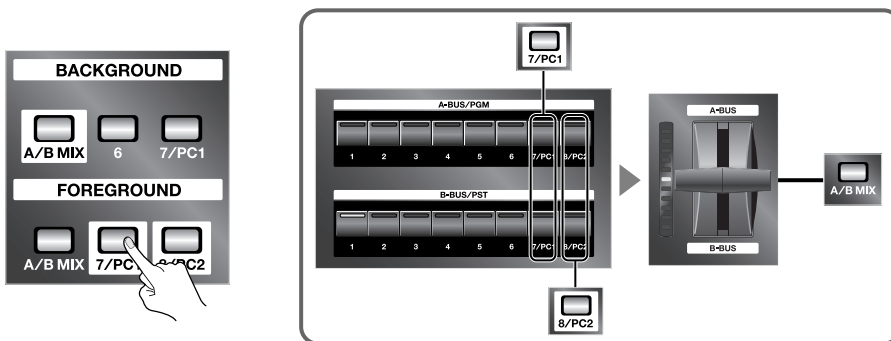

3. Decide how the keyed material appears and disappears.

Decide how the picture you selected in step 2 to appears and disappears. Select either [CUT] or [MIX]. Selecting [CUT] makes the foreground picture appear and disappear instantly. Selecting [MIX] makes it fade in and fade out. You can set the time for the fade-in and fade-out (from 0 to 4 seconds) by turning the [TIME] dial.

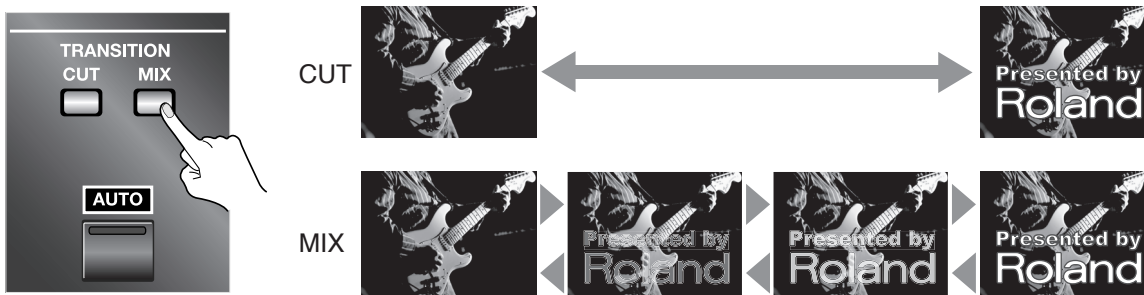

Using the Downstream Keyer (DSK)

4. Perform composition and output.

Pressing the [AUTO] button for DSK performs composition of the selected FOREGROUND picture superimposed on the selected BACKGROUND picture. The composited video is output to a projector or other device connected to the PGM OUT connectors.



5. Adjust the key level.

You can adjust the key level by turning the [KEY LEVEL] dial. Turning it all the way to [MIN] makes no key composition at all, and outputs the FOREGROUND picture unchanged. At [MAX], keying is maximum, and only the BACKGROUND picture is output. Find the place where the key level is exactly right.



MEMO

By default, black is the key color used in key composition. Keyed material featuring white, yellow or brightly colored (non-dark) text or logos on a black background produces optimal “overlay” onto your background video. You can also use the menus to select a different color. Refer to “Changing Settings Using the Menu” (p. 36) and “Menu List” (p. 38).

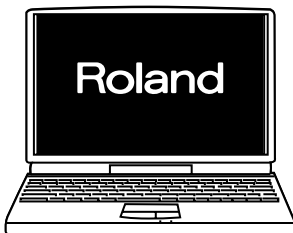

MEMO

You can also add edge blur (soft edges) to text or logos displayed in the composited foreground. Edge blur can help reduce jagged, noisy edges on your key material. The degree of blur is set using the menus. Refer to “Changing Settings Using the Menu” (p. 36) and “Menu List” (p. 38).

TIP

You can also display the FOREGROUND picture as an inset screen using Picture-in-Picture, instead of using key composition. You use the menus to change the DSK mode. Refer to “Changing Settings Using the Menu” (p. 36) and “Menu List” (p. 38).

Combining DSK and Picture-in-Picture

With the LVS-800, you can perform DSK composition, then also apply Picture-in-Picture (PinP). This lets you display logos or other elements in smaller size and at the place you want on the screen. For information on how to select the background and foreground video, refer to the previous section.

**When key composition and Picture-in-Picture are used in combination, the Border and Shadow settings assigned to PinP1 through PinP4 have no effect. Only the settings for location and size are effective.*



1. From the menu, select “DSK Setup” and “DSP PinP.”

Press the [MENU] button to display the menu screen. From the list that appears, use UP or DOWN to highlight “DSK Setup,” then press the [ENTER] button. From the list that appears, choose “DSK PinP.” After making the selection, press the [ENTER] button.

**The on-screen menu will only appear on a monitor connected to the A/B MIX PVW jack.*

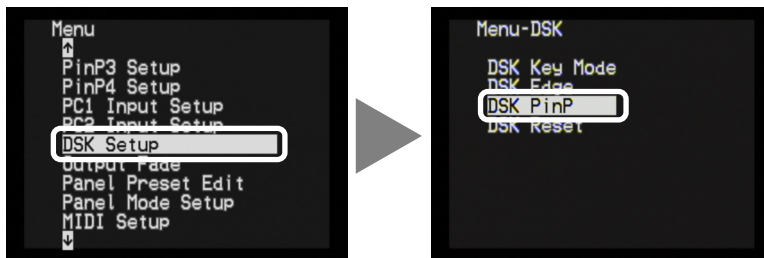

2. Decide on the P in P number.

By default, this is set to “Off.” Choose the number from “PinP1” to “PinP4”. After making the selection, press the [MENU] button three times to quit the menu display.



3. Perform composition and output.

Pressing the [AUTO] button for DSK reduces the size of the FOREGROUND picture according to the setting of PinP1 through PinP4, and performs composition of the FOREGROUND picture superimposed on the BACKGROUND picture.

4. Adjust the key level.

You can adjust the key level by turning the [KEY LEVEL] dial.

Applying Fade to the Final Output

You can apply fade-in or fade-out to the output from the PGM OUT connectors (the program output).

Pressing the [AUTO] button for PGM OUTPUT FADE makes the button's LED flash and starts a fade-out. When the fade-out has been completed, the button stops flashing and stays lit. Press the PGM OUTPUT FADE button again to start a fade-in. When the fade-in ends, the LED goes dark.

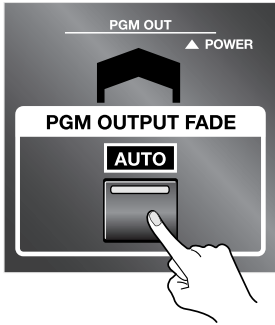

If you want to change the fade-in or fade-out time (to any value from 0 to 4 seconds), adjust it using the TIME dial.



MEMO

By default, black is the color used for fades. You can also use the menus to select white. Refer to "Changing Settings Using the Menu" (p. 36) and "Menu List" (p. 38).

Saving Settings to PANEL PRESET Buttons

You can save the state of various controls to [PANEL PRESET] buttons. Saving lets you call up a variety of settings at the press of a button. The [PANEL PRESET] buttons are numbered from 1 to 12, and let you save up to 12 sets of settings. You can save the state of the controls described below.

	Items	Parameters to save
A/B MIX Section	Bus A Input Selector	Selected input channel
	Bus B Input Selector	Selected input channel
	PinP Button	Selected PinP position (1-4)
	TRANSITION Button	Selected transition effect type
	Video Fader	Position between A and B *
DSK Section	BACKGROUND Button	Background channel
	FOREGROUND Button	Foreground channel
	TRANSITION Button	Appearance and disappearance of foreground
	AUTO Button	Output or non-output of foreground
	KEY LEVEL Dial	Level of keyer
	DSK Key Mode	Color of keyer
	DSK PinP	On/Off of DSK PinP and the position (1-4)
Others	TIME Dial	Time of transition and PGM output fade
	PGM OUTPUT FADE	Output or non-output of program picture

*The internal position between A and B of the video fader is indicated by the lighted location of the TRANSITION indicator next to the video fader. This may not necessarily match the position of the video fader. To make these match up, move the video fader forward and backward all the way.

Saving the Current Settings

Follow the steps described below to save the current state.

1. Put the unit in the state you want to save.

Make the settings for the bus input channels, Picture-in-Picture, and other values.

2. Save the settings.

To save the settings to one of the [PANEL PRESET] buttons from 1 through 6, press and hold the button for three seconds or longer.

To save the settings to a button from 7 through 12, press the [SHIFT] button to make it light up, then press and hold the desired button for three seconds or longer.

When all [PANEL PRESET] buttons flash, the saving operation has finished.

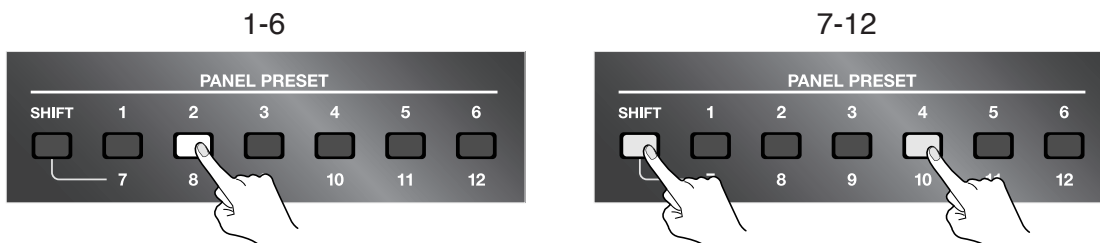

Calling Up Saved Settings

To recall values that have been saved, press the button corresponding to the number you want to call up. The pressed button lights up and the saved values are recalled. Recalling settings in this way puts the various controls in the same state they were in when the settings were saved. The pressed button lights up while the recalled state remains in effect. If the called-up state is changed, the button goes dark.

*To call up values saved at a button from 7 through 12, press the [SHIFT] button, then press the numbered button.

Saving Settings to PANEL PRESET Buttons

Copying Saved Settings to Another Button

You can copy the settings saved from any Panel Preset button to another Panel Preset button. Use the menus to perform the copy operation. For information on how to use the menus, refer to “Changing Settings Using the Menu” (p. 36).

**To view the on-screen menu, you need to have a monitor connected to the A/B MIX PVW jack.*

NOTE

Executing a copy operation overwrites any existing settings at the copy destination, causing any previously saved settings to be lost.

1. Display the menu.

Press the [MENU] button to display the menu.

2. Select “Panel Preset Edit.”

From the list that appears, choose “Panel Preset Edit,” then press the [ENTER] button.



3. Select “Copy.”

From the list that appears, choose “Copy,” then press the [ENTER] button.



4. Select the numbers of the copy source and destination.

The number displayed on the left side of the screen is the copy source. Use the arrow buttons to select the number of the copy source, then press the [ENTER] button. Pressing this displays a number for the copy destination on the right side of the screen. Use the arrow buttons to select the number of the copy destination, then press the [ENTER] button.

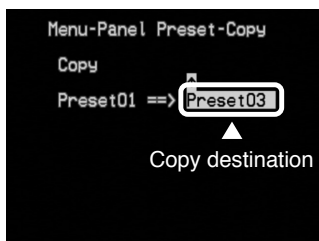
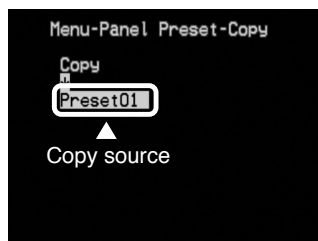

5. Execute the copy operation.

To execute the copy operation, select “Yes [ENTER] SW” and press the [ENTER] button. To cancel execution, select “No” and press the [ENTER] button. When the operation has ended, press the [MENU] button several times to quit the menu display.

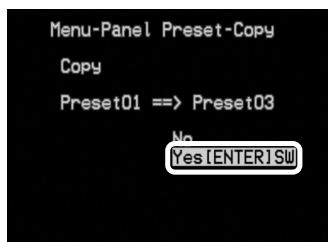

Exchanging Saved Settings with Another Button

You can exchange (swap) the settings saved at any button with the settings at another button. Use the menus to perform the exchange operation. For information on how to use the menus, refer to “Changing Settings Using the Menu” (p. 36).

1. Display the menu.

Press the [MENU] button to display the menu.

2. Select “Panel Preset Edit.”

From the list that appears, choose “Panel Preset Edit,” then press the [ENTER] button.



3. Select “Exchange.”

From the list that appears, choose “Exchange,” then press the [ENTER] button.



4. Select the numbers of the exchange source and destination.

The number displayed on the left side of the screen is the exchange source. Use the arrow buttons to select the number of the exchange source, then press the [ENTER] button. Pressing this displays a number for the exchange destination on the right side of the screen. Use the arrow buttons to select the number of the exchange destination, then press the [ENTER] button.

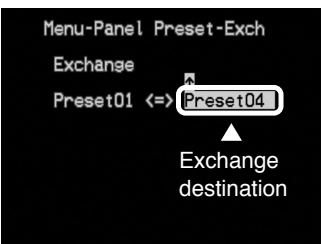

5. Execute the exchange operation.

To execute the exchange operation, select “Yes [ENTER] SW” and press the [ENTER] button. To cancel execution, select “No” and press the [ENTER] button. When the operation has ended, press the [MENU] button several times to quit the menu display.

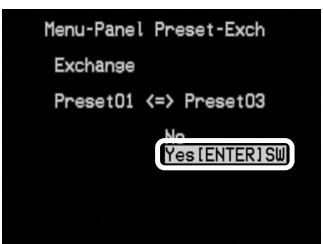

Returning to Factory-default State (Factory Reset)

This returns various settings to their factory defaults.

Executing a factory reset causes all settings and saved values except the following settings to be lost.

(Please be aware that settings saved to PANEL PRESET buttons are also lost.)

- NTSC/PAL setting (p. 35)
- Calibration of the video fader (Video Fader Calibrate A/B)

**To view the on-screen menu, you need to have a monitor connected to the A/B MIX PVW jack.*

1. At the menu, choose “Factory Reset.”

Press the [MENU] button to display the menu. From the list, choose “Factory Reset,” then press the [ENTER] button.



2. Choose “Yes [ENTER] SW.”

Use the arrow buttons to choose “Yes [ENTER] SW.”

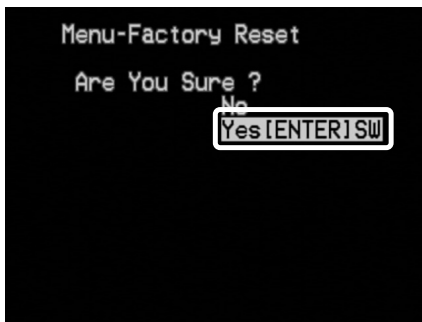

3. Execute FACTORY RESET.

Pressing the [ENTER] button returns the unit to its factory-default state.

**Pressing the [MENU] button at this stage returns you to the previous screen without returning the unit to its factory-default state.*

4. Quit the menu screen.

Press the [MENU] button several times to make the menu display disappear.

Switching Between NTSC and PAL

The LVS-800 can switch to NTSC or PAL at startup.

Switching to NTSC at Startup

At the DSK section, under [BACKGROUND], hold down the [A/B MIX] and [7/PC1] buttons and turn on the power. Once set to NTSC, the setting persists in memory even after power off.

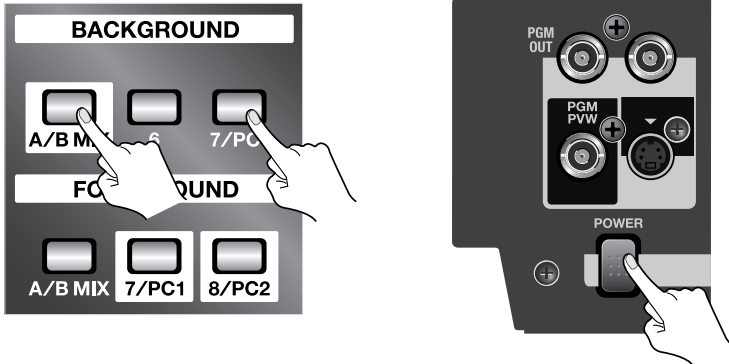

Switching to PAL at Startup

At the DSK section, under [FOREGROUND], hold down the [A/B MIX] and [8/PC2] buttons and turn on the power. Once set to PAL, the setting persists in memory even after power off.

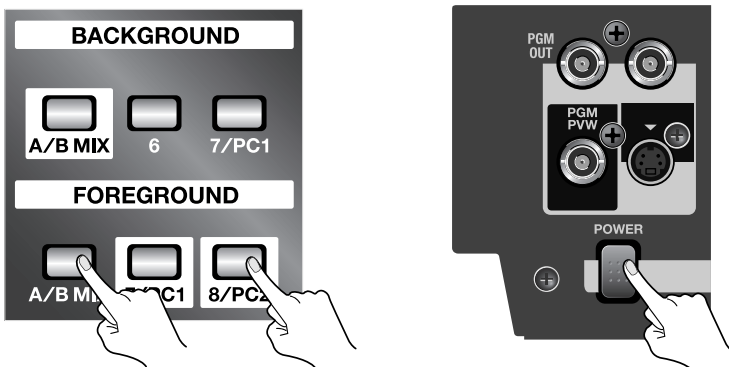

MEMO

You can also use the menus to switch between NTSC and PAL. At the "Utility" menu, choose "NTSC/PAL," then select "NTSC" or "PAL." After this operation, the setting requires some time to take effect.

Changing Settings Using the Menus

Making changes to various settings, including the operation mode and the location and size of the inset screen for Picture-in-Picture, are tasks you perform after first displaying the menus.

Displaying the Menus

The menus are displayed in the preview monitor connected to the A/B MIX PVW connector. When you're performing menu operations, first be sure to connect a preview monitor.

Pressing the [MENU] button displays the menu screen on the preview monitor.

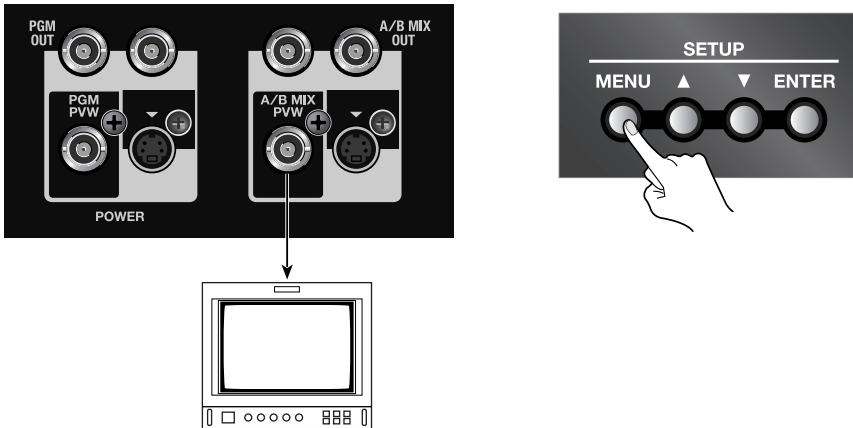

Menu Levels

The menus are structured using the level hierarchy shown below. Selecting an upper-level item displays the lower level for setting the value.

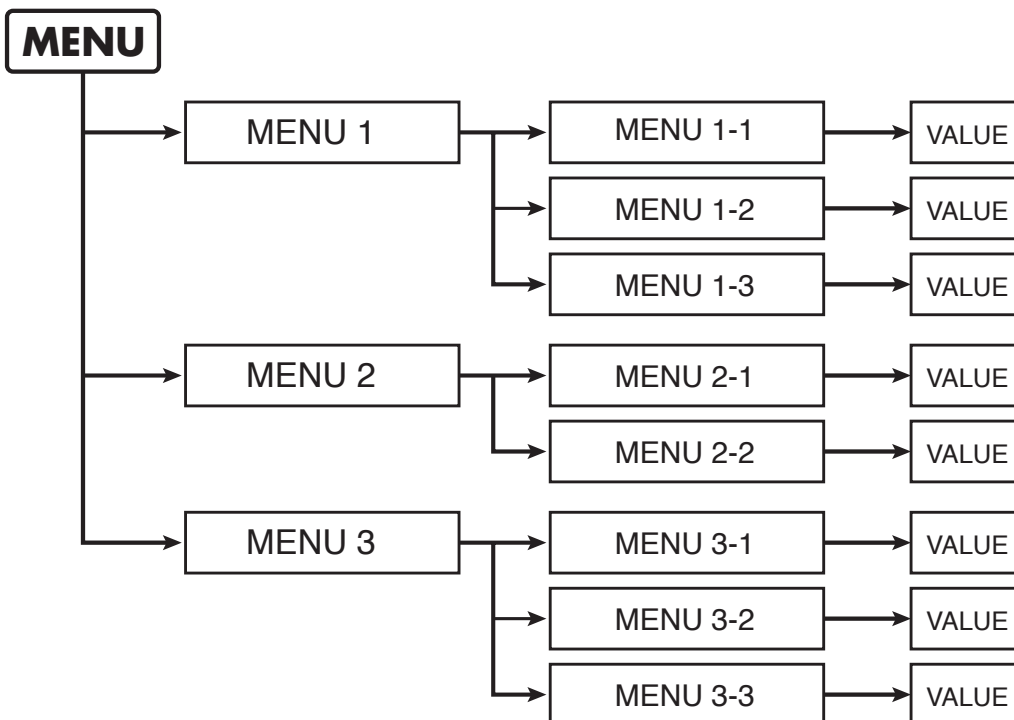

Menu Operations

Use the procedure described below to change various settings.

1. Display the menu.

Go to SETUP and press the [MENU] button. The menu screen appears on the preview monitor.

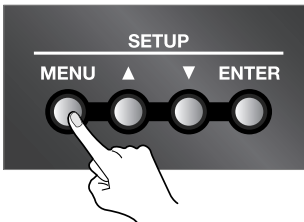

2. Choose the item whose setting you want to change.

Use the up and down arrow buttons to choose the item whose setting you want to change.

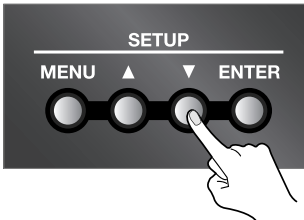

3. Decide on the setting-change item.

Press the [ENTER] button to move down one level.

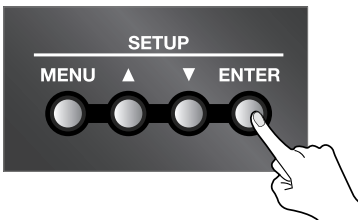

**If the menu item is located at a deeper level, repeat steps 2 and 3.*

**To go back to the original level, press the [MENU] button.*

4. Change the setting value.

Use the up and down arrow buttons to change the setting value.

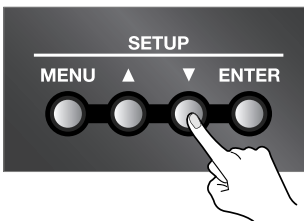

5. End the menu display.

Press the [MENU] button several times to make the menu display disappear.

MEMO

The values of menu settings are saved in internal memory when you exit the menu. To save the values of settings, exit the menu screen before you turn off the power.

Menu List

Going to SETUP and pressing the [MENU] button starts by displaying the menu items at the first level.
For information on the menu items at the second level, refer to the following pages.

MENU	→ Wipe1 Setup	This chooses the wipe pattern and other such settings assigned to the Wipe1 button.
	→ Wipe2 Setup	This chooses the wipe pattern and other such settings assigned to the Wipe2 button.
	→ PinP1 Setup	This sets the location, size, and the like of the PinP1 inset screen.
	→ PinP2 Setup	This sets the location, size, and the like of the PinP2 inset screen.
	→ PinP3 Setup	This sets the location, size, and the like of the PinP3 inset screen.
	→ PinP4 Setup	This sets the location, size, and the like of the PinP4 inset screen.
	→ PC1 Input Setup	This sets the location, size, color, and the like for PC1 input.
	→ PC2 Input Setup	This sets the location, size, color, and the like for PC2 input.
	→ DSK Setup	This sets color and degree of edge blur for keyer, and sets whether PinP is on or off.
	→ Output Fade	This sets the color for Output Fade (white or black).
	→ Panel Preset Edit	This performs copying, exchange, and other such operations for Panel Preset settings.
	→ Panel Mode Setup	This changes the operation mode of the LVS-800.
	→ MIDI Setup	This sets the send and receive channel and other values for MIDI (for remote control).
	→ Utility	This makes a variety of system settings.
	→ Factory Reset	This returns the LVS-800 to its factory-default state.

**For more information about Factory Reset, refer to "Returning the Unit to Its Factory-default State" (p. 34).*

Wipe Setup Menu

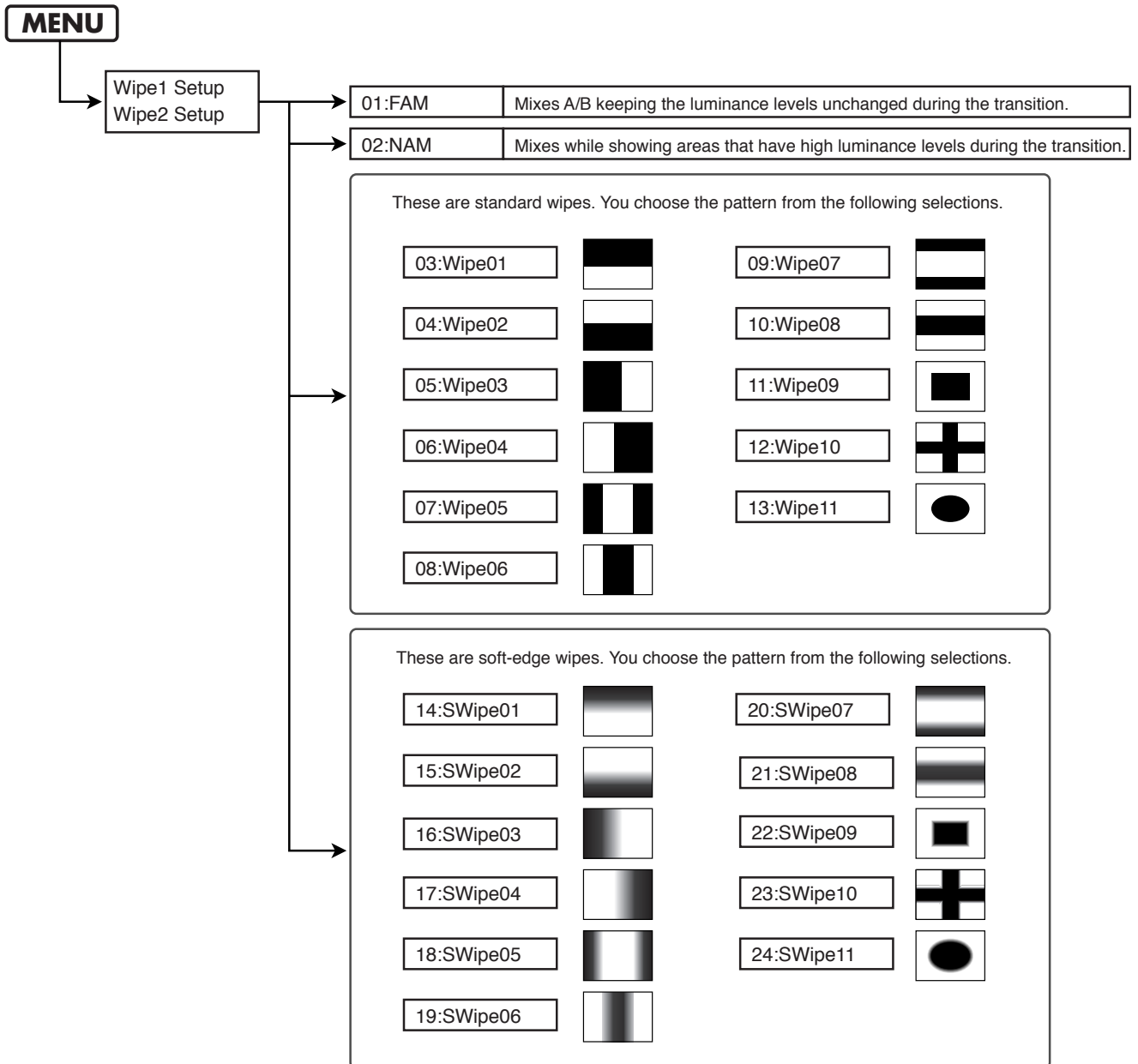

MEMO

When shipped from the factory, 05:Wipe03 is assigned to WIPE1 and 22:SWipe09 is assign to WIPE2 by default.

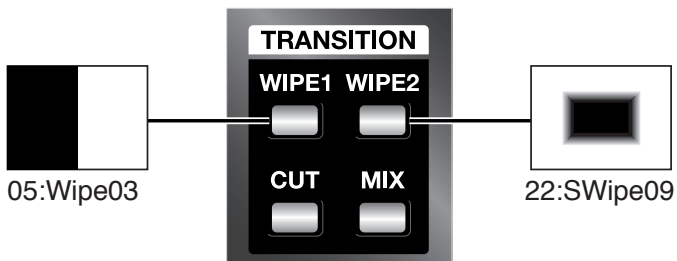

Menu List

PinP Setup Menu

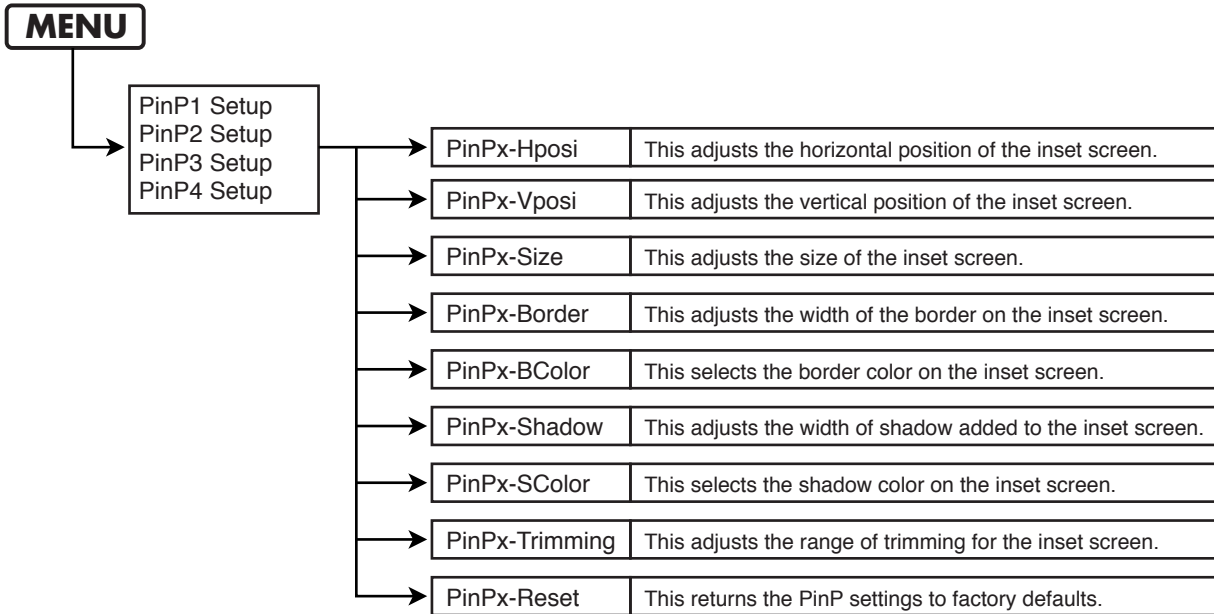

**In the "PinPx-Hposi" and other items described above, a number from 1 through 4 appears at the location shown by "x." For example, a "1" is inserted when "PinP1 Setup" has been selected, and a "4" is inserted when "PinP4 Setup" has been selected.*

MEMO

In the factory-default state, the locations of the inset screen for PinP1 through PinP4 are as shown below. All selections from 1 through 4 have a white border added. By default, no shadow is added.

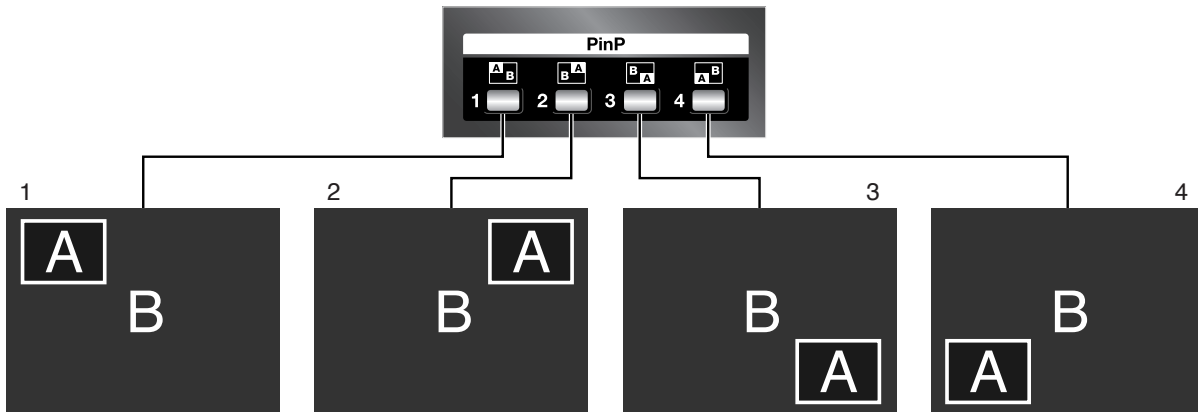

PC Input Setup Menu

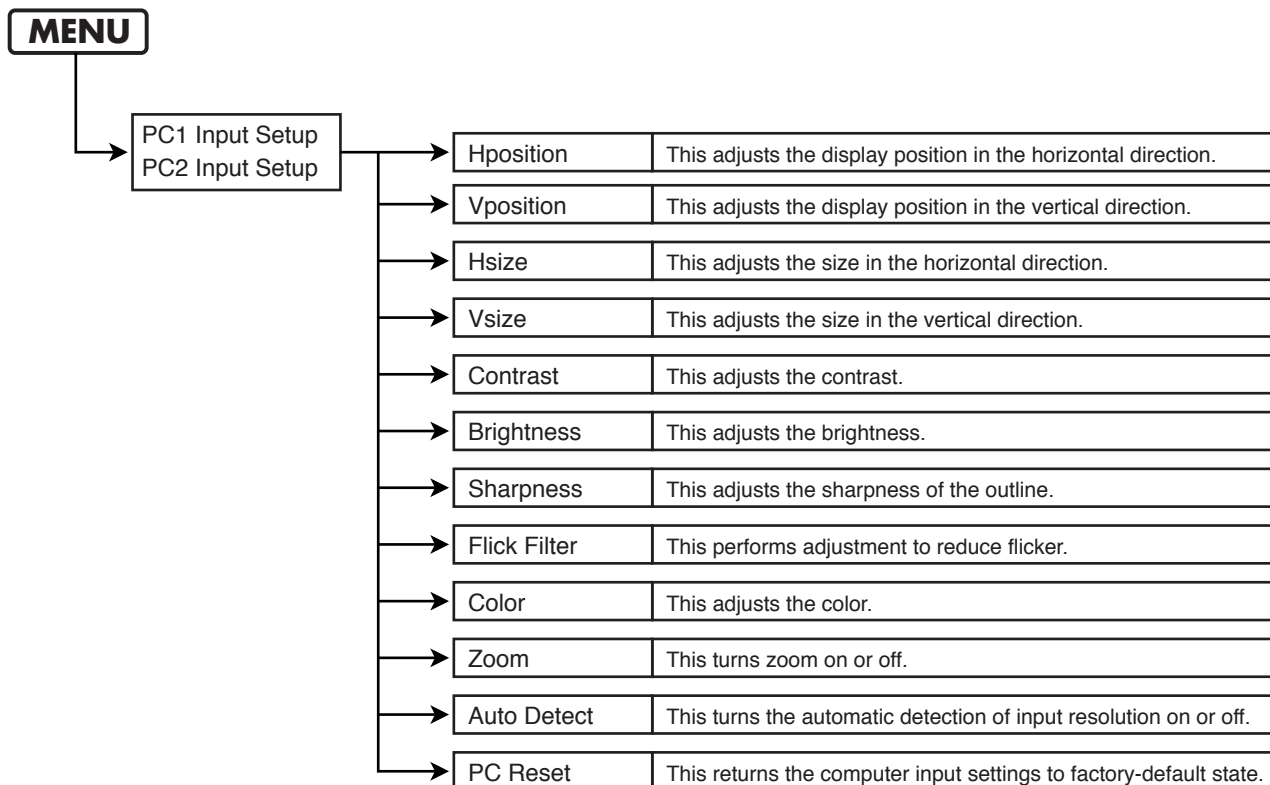

DSK Setup Menu

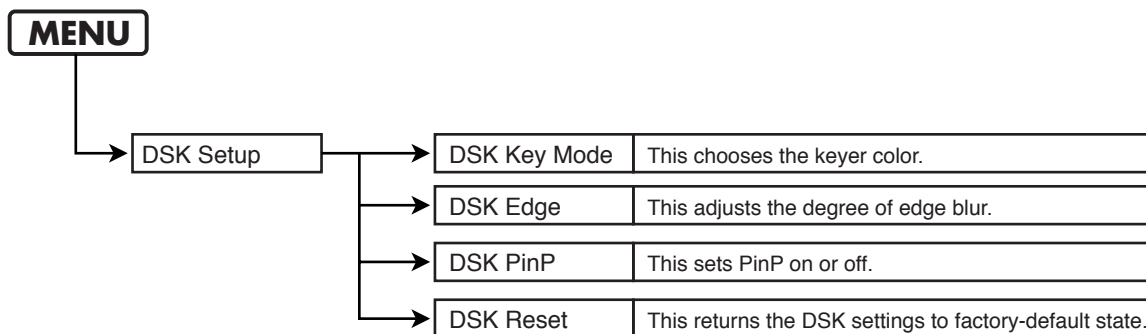

MEMO

In the factory-default state, black is the key color for key composition. This produces attractive composition of white text or logos on a black background, as shown below. Edges are slightly blurred.

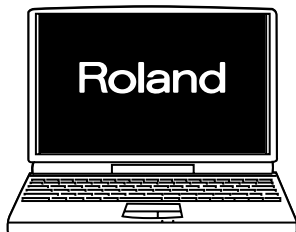

Menu List

Output Fade Menu

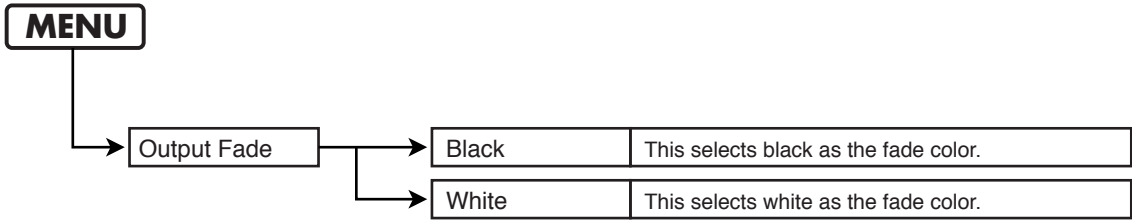

MEMO

In the factory-default state, this is set to black.

Panel Preset Edit Menu

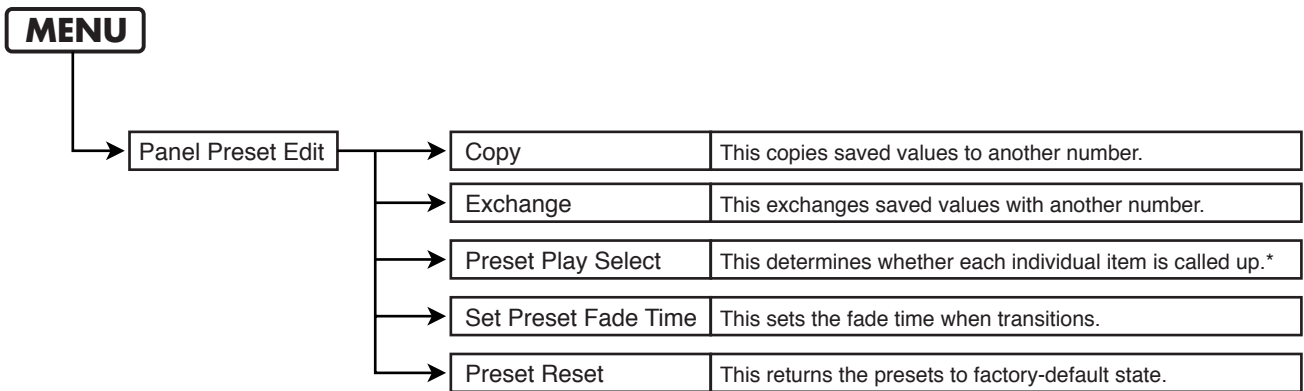

**When a saved state is recalled by pressing a PANEL PRESET button, only items for which "Load" has been selected are called up. The saved state is not called up for items for which "Free" has been selected. When you want to keep the input channels for A Bus and B Bus unchanged while changing the values of all other items to a saved state, set the "A-BUS/B-BUS" item to "Free."*

MEMO

In the factory-default state, all items are set to "Load." This means the saved state is called up for all items.

Panel Mode Setup Menu

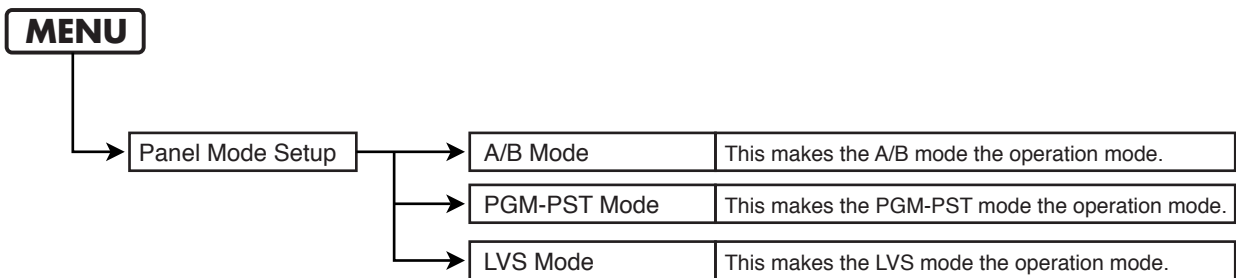

MEMO

In the factory-default state, the A/B mode is set as the operation mode. For more information on how to operate the unit in other modes, refer to "Use in Other Operation Modes Besides the A/B Mode" (p. 19).

MIDI Setup Menu

These settings are required when operating the unit by remote control.

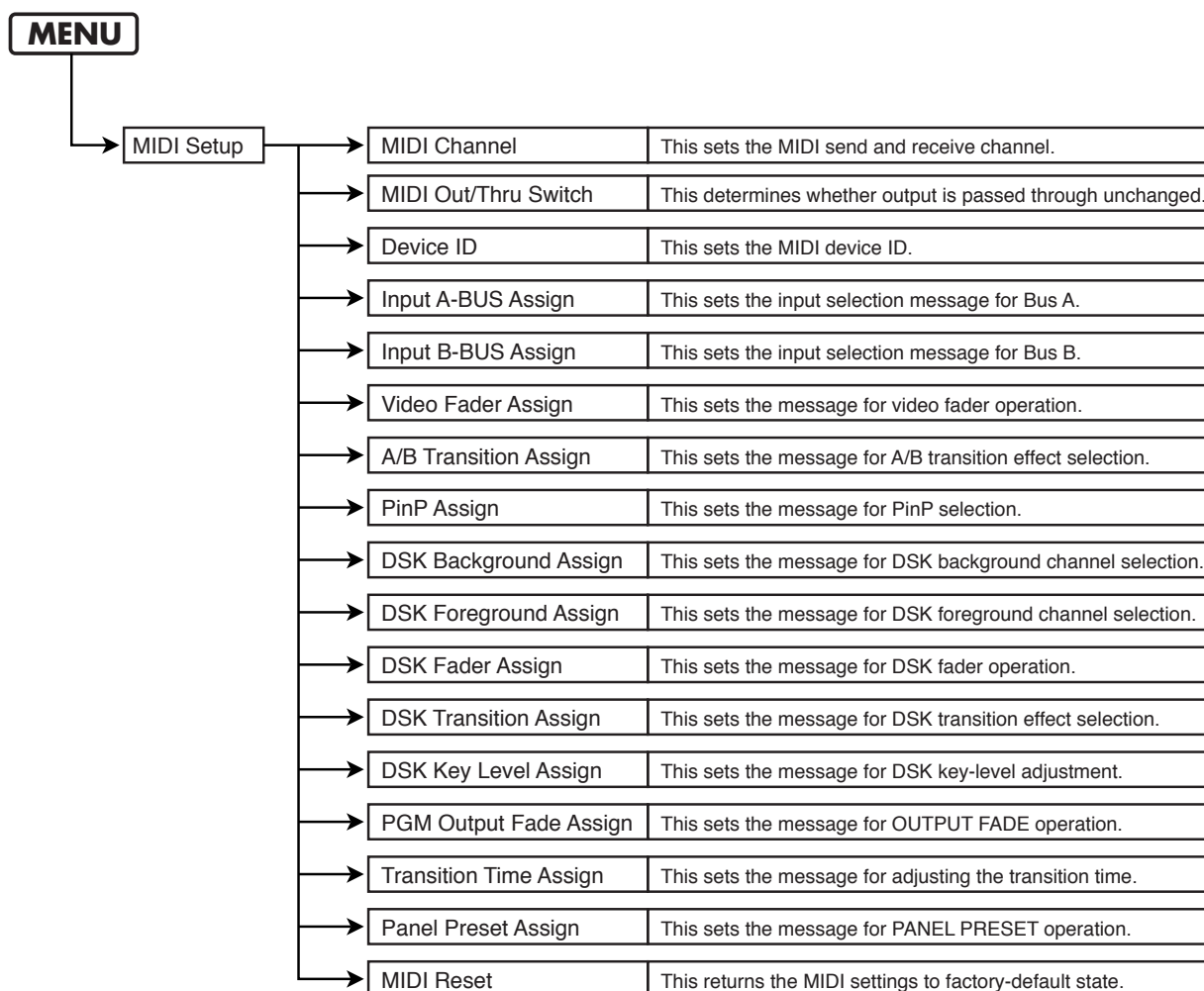

Utility Menu

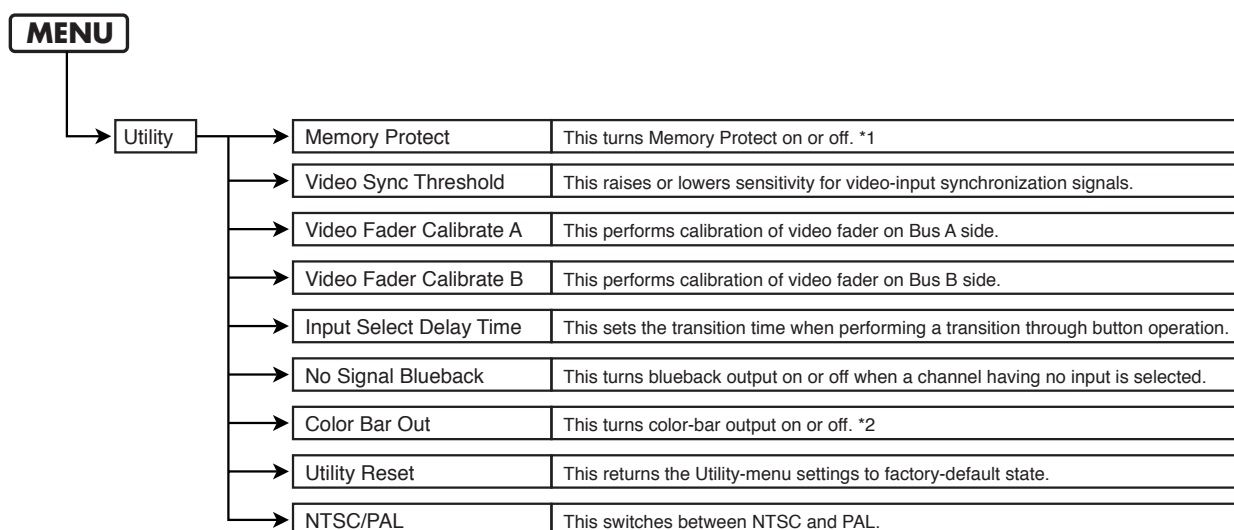

*1 When Memory Protect is on, PANEL PRESET settings can be called up, but setting values cannot be changed or saved. It also becomes impossible to change the setting values for any menu items.

*2 The settings for other items persist in memory after the power is switched off, but the on/off setting for color-bar output is not saved.

Troubleshooting

Power Supply

The power does not come on when the POWER switch is turned on.

- Is an AC adapter other than the included one being connected? Use the included AC adapter (Roland PSB-7U).

Video Output

No picture is output.

- If the PGM OUTPUT FADE button illuminated? No video is output while the output fade button is lighted.
“Applying Fade to the Final Output (PGM OUT)” (p. 30)
- Are the selections for the input channels correct? When selecting the input for A Bus or B Bus, selecting a channel that has no input signal results in no picture being output.
“Switching Between A Bus and B Bus” (p. 16)
- Is any signal being output from the connected camera or playback device? Check the source monitor connected to a MONITOR OUT connector.

The picture is corrupt.

- Is the selection of NTSC or PAL correct?
“Switching Between NTSC and PAL” (p. 35)
- The signal from the camera or other source device may be below the threshold value. Go to the “Utility” menu and try adjusting the “Video Sync Threshold” setting.
- A weak incoming video signal can cause PGM output to be black-and-white or distorted. Make sure your video source devices and cabling are providing adequate video signal.
- Is a moving image being input from a computer? Flicker or skew may occur in moving images input from a computer. This is called tearing, and does not indicate an equipment malfunction.
- Was the input channel for one bus changed while the video fader was at a position short of fully moved to the opposite end? When you’re switching the input channel for the bus other than the one displayed, first move the video fader all the way to the end of its stroke.
“Switching Between A Bus and B Bus” (p. 16)

Operating the video fader does not change the picture.

- Is the same input channel selected for A Bus and B Bus? If the same input channel has been selected, operating the video fader does not change the output picture.
“Switching Between A Bus and B Bus” (p. 16)
- Is the operation mode set to the PGM-PST mode? In this mode, only button operations can be used to change the picture. Operating the video fader has no effect.
“Use in Other Operation Modes Besides the A/B Mode” (p. 19)
- The video fader might not be calibrated correctly. To perform calibration, go to the “Utility” menu and execute “Video Fader Calibrate” (A and B). Move the control all the way to the A Bus end and execute “Video Fader Calibrate A,” then move it all the way to the B Bus end and execute “Video Fader Calibrate B.”

DSK

Logos or text from a computer are not displayed.

- Is the video output from the computer in a format that the LVS-800 does not support? Change the settings on the computer to enable output in a supported format.
“Connecting Computers” (p. 11)
- Is the input from the computer selected as the FOREGROUND picture? No key composition is applied to the BACKGROUND picture.
- Is KEY LEVEL for DSK set at MAX? Turning the dial all the way to MAX makes the picture set as FOREGROUND disappear from view.
“Trying Out DSK Composition” (p. 27)

Composition with the background picture does not look correct.

- Has the color to use for key composition been set correctly? By default, black is used for composition. Inputting a background image of a color other than black results in incorrect compositing with the background picture. Go to the “DSK Setup” menu and use “DSK Key Mode” to change the color to use for key composition.
“Trying Out DSK Composition” (p. 27)

Others

Menu settings are not saved.

- Was the power turned off before you quit the menu display? The values of menu settings are saved in internal memory when you exit the menu. To save the values of settings after making any changes, first quit the menu display before you switch off the power.

Settings cannot be saved to a PANEL PRESET.

- Do the controls allow their states to be saved? For some controls, saving the current state is not possible.
- Was the button used as the destination for saving held depressed until all PANEL PRESET buttons started to flash? Holding down the button for several seconds makes the buttons flash and saves the settings in internal memory, but the values are not saved until the buttons flash. "Saving Settings to PANEL RESET Buttons" (p. 31)
- Is Memory Protect set at the "On" setting? Go to the "Utility" menu, choose "Memory Protect," and select "Off." The unit cannot be returned to its factory-default state.
- Is Memory Protect set at the "On" setting? Go to the "Utility" menu, choose "Memory Protect," and select "Off."

Main Specifications

Video Processing		Input Connectors	
Format	NTSC/PAL (ITU601)	Video	S-Video (4 pins mini DIN type) x 4 (ch 5, 6, 7, 8) Composite (BNC type) x 6 (ch 1, 2, 3, 4, 5, 6) * If S-Video is simultaneously input to 5-8, S-Video takes priority.
Sampling	13.5 MHz, 4:2:2 (Y:R-Y:B-Y), 8 bit	RGB	D-Sub 15 pin shrink type x 2 (PC1, PC2) * If S-Video is simultaneously input to ch 7-8, S-Video takes priority.
Frame Synchronizer	Built in x 3	Remote Control	MIDI (IN, OUT/THRU), RS-232C (D-Sub 9 pin type)
Supported RGB Inputs	640 x 480/120 Hz, 800 x 600/120 Hz, 832 x 624/75 Hz, 1024 x 768/80 Hz, 1152 x 864/80 Hz, 1152 x 870/75 Hz, 1280 x 1024/75 Hz, 1600 x 1200/60 Hz * Conforms to VESA DMT Ver 1.0 Revision 10 * The refresh rate is the maximum value of each resolution.	Output Connectors	
Input Level and Impedance		MONITOR	Composite (BNC type) x 6
Video (Composite)	1.0Vp-p, 75 ohms	A/B MIX	S-Video (4 pins mini DIN type) x 1, Composite (BNC type) x 2
S-Video	Luminance signal : 1.0 Vp-p, 75 ohms Chrominance Signal : 0.286 Vp-p, 75 ohms (NTSC) 0.3 Vp-p, 75 ohms (PAL)	A/B MIX PVW	Composite (BNC type) x 1 * Preview and OSD Menu
PC-RGB	0.7 Vp-p, 75 ohms (H, V:5VTTL)	PGM OUT	S-Video (4 pins mini DIN type) x 1, Composite (BNC type) x 2
Output Level and Impedance		PGM OUT PVW	Composite (BNC type) x 1 * Preview of ch 6-8 or A/B MIX OUT
Video (Composite)	1.0 Vp-p, 75 ohms	TALLY	D-Sub 15 pin shrink type x 1, Max Input : 12 V, 200 mA Open collector type
S-Video	Luminance signal : 1.0 Vp-p, 75 ohms Chrominance Signal : 0.286 Vp-p, 75 ohms (NTSC) 0.3 Vp-p, 75 ohms (PAL)	Others	
Transition Effects		Power Supply	AC Adaptor : Roland PSB-7U
A/B MIX	Cut, Mix, Hard Edge Wipe, Soft Edge Wipe	Current Draw	2,200 mA
DSK	Cut, Mix	Dimensions	376.0(W) x 315(D) x 136(H) mm 14-13/16(W) x 12-7/16(D) x 5-3/8 (D) inches
Composition Effects		Weight	4.3 kg 9 lbs 8 oz
A/B MIX	Picture In Picture	Accessories	AC Adaptor (Roland PSB-7U), RCA to BNC adaptor x 4, Owner's Manual
DSK	Luminance Key, Chroma Key, Picture In Picture		

**In the interest of product improvement, the specifications and/or appearance of this unit are subject to change without prior notice.*

Remote Control

For more information about remote control via MIDI, V-LINK, or the RS-232C interface, please download the separately available reference document from the following Roland website.

<http://www.rolandsystemsgroup.net/>

Index

A	
A/B MIX OUT	10
A/B MIX PVW	10
A/B Mode	16
AUTO Button	18
B	
background	9, 27
C	
Cord Hook	14
D	
Downstream Keyer	26
DSK	26, 29
F	
Factory Reset	34
Fade	30
Final Output	30
foreground	9, 27
G	
ground terminal	14
K	
KEY LEVEL	9
L	
LVS Mode	21
LVS mode	19
M	
Menu	36
Menu List	38
MIDI	8
MONITOR OUT	10
N	
NTSC	35
O	
Operation Mode	19
OUTPUT FADE	9
P	
PAL	35
PANEL PRESET	8, 31
PC INPUT	10
PGM OUT	10
PGM PVW	10
PGM-PST Mode	20
PGM-PST mode	19
Picture-in-Picture	22
PinP	8
R	
RS-232C	10
S	
SETUP	8
Source	11
T	
TALLY	10, 13
T-bar	9
TIME Dial	8
transition	9
transition effect	16
transition time	18
V	
video fader	9
VIDEO INPUT	10
V-LINK	8

Memo

Memo

For EU Countries



- UK** This symbol indicates that in EU countries, this product must be collected separately from household waste, as defined in each region. Products bearing this symbol must not be discarded together with household waste.
- DE** Dieses Symbol bedeutet, dass dieses Produkt in EU-Ländern getrennt vom Hausmüll gesammelt werden muss gemäß den regionalen Bestimmungen. Mit diesem Symbol gekennzeichnete Produkte dürfen nicht zusammen mit dem Hausmüll entsorgt werden.
- FR** Ce symbole indique que dans les pays de l'Union européenne, ce produit doit être collecté séparément des ordures ménagères selon les directives en vigueur dans chacun de ces pays. Les produits portant ce symbole ne doivent pas être mis au rebut avec les ordures ménagères.
- IT** Questo simbolo indica che nei paesi della Comunità europea questo prodotto deve essere smaltito separatamente dai normali rifiuti domestici, secondo la legislazione in vigore in ciascun paese. I prodotti che riportano questo simbolo non devono essere smaltiti insieme ai rifiuti domestici. Ai sensi dell'art. 13 del D.Lgs. 25 luglio 2005 n. 151.
- ES** Este símbolo indica que en los países de la Unión Europea este producto debe recogerse aparte de los residuos domésticos, tal como está regulado en cada zona. Los productos con este símbolo no se deben depositar con los residuos domésticos.
- PT** Este símbolo indica que nos países da UE, a recolha deste produto deverá ser feita separadamente do lixo doméstico, de acordo com os regulamentos de cada região. Os produtos que apresentem este símbolo não deverão ser eliminados juntamente com o lixo doméstico.
- NL** Dit symbool geeft aan dat in landen van de EU dit product gescheiden van huishoudelijk afval moet worden aangeboden, zoals bepaald per gemeente of regio. Producten die van dit symbool zijn voorzien, mogen niet samen met huishoudelijk afval worden verwijderd.
- DK** Dette symbol angiver, at i EU-lande skal dette produkt opsamles adskilt fra husholdningsaffald, som defineret i hver enkelt region. Produkter med dette symbol må ikke smides ud sammen med husholdningsaffald.
- NO** Dette symbolet indikerer at produktet må behandles som spesialavfall i EU-land, iht. til retningslinjer for den enkelte regionen, og ikke kastes sammen med vanlig husholdningsavfall. Produkter som er merket med dette symbolet, må ikke kastes sammen med vanlig husholdningsavfall.

- SE** Symbolen anger att i EU-länder måste den här produkten kasseras separat från hushållsavfall, i enlighet med varje regions bestämmelser. Produkter med den här symbolen får inte kasseras tillsammans med hushållsavfall.
- FI** Tämä merkintä ilmaisee, että tuote on EU-maissa kerättävä erillään kotitalousjätteistä kunkin alueen voimassa olevien määräysten mukaisesti. Tällä merkinnällä varustettuja tuotteita ei saa hävittää kotitalousjätteiden mukana.
- HU** Ez a szimbólum azt jelenti, hogy az Európai Unióban ezt a terméket a háztartási hulladéktól elkülönítve, az adott régióban érvényes szabályozás szerint kell gyűjteni. Az ezzel a szimbólummal ellátott termékeket nem szabad a háztartási hulladék közé dobni.
- PL** Symbol oznacza, że zgodnie z regulacjami w odpowiednim regionie, w krajach UE produktu nie należy wyrzucać z odpadami domowymi. Produktów opatrzonych tym symbolem nie można utylizować razem z odpadami domowymi.
- CZ** Tento symbol udává, že v zemích EU musí být tento výrobek sbíráán odděleně od domácího odpadu, jak je určeno pro každý region. Výrobky nesoucí tento symbol se nesmí vyhazovat spolu s domácím odpadem.
- SK** Tento symbol vyjadruje, že v krajinách EÚ sa musí zber tohto produktu vykonávať oddelene od domového odpadu, podľa nariadení platných v konkrétnej krajine. Produkty s týmto symbolom sa nesmú vyhazovať spolu s domovým odpadom.
- EE** See sümbol näitab, et EL-i maades tuleb see toode olemprügist eraldi koguda, nii nagu on igas piirkonnas määratletud. Selle sümboliga märgitud tooteid ei tohi ära visata koos olmeprügiga.
- LT** Šis simbolis rodo, kad ES šalyse šis produktas turi būti surenkamas atskirai nuo buitinių atliekų, kaip nustatyta kiekviename regione. Šiuo simboliu paženklinėti produktai neturi būti išmetami kartu su buitiniemis atliekomis.
- LV** Šis simbols norāda, ka ES valstīs šo produktu jāievāc atsevišķi no mājsaimniecības atkritumiem, kā noteikts katrā reģionā. Produkts ar šo simbolu nedrīkst izmest kopā ar mājsaimniecības atkritumiem.
- SI** Ta simbol označuje, da je treba proizvod v državah EU zbirati ločeno od gospodinskih odpadkov, tako kot je določeno v vsaki regiji. Proizvoda s tem znakom ni dovoljeno odlagati skupaj z gospodinskimi odpadki.
- GR** Το σύμβολο αυτό υποδηλώνει ότι στις χώρες της Ε.Ε. το συγκεκριμένο προϊόν πρέπει να συλλέγεται χωριστά από τα υπόλοιπα οικιακά απορρίμματα, σύμφωνα με όσα προβλέπονται σε κάθε περιοχή. Τα προϊόντα που φέρουν το συγκεκριμένο σύμβολο δεν πρέπει να απορρίπτονται μαζί με τα οικιακά απορρίμματα.

For China

有关产品中所含有害物质的说明

本资料就本公司产品中所含的特定有害物质及其安全性予以说明。
本资料适用于 2007 年 3 月 1 日以后本公司所制造的产品。

环保使用期限



此标志适用于在中国国内销售的电子信息产品，表示环保使用期限的年数。所谓环保使用期限是指在自制造日期的规定期限内，产品中所含的有害物质不致引起环境污染，不会对人身、财产造成严重的不良影响。
环保使用期限仅在遵照产品使用说明书，正确使用产品的条件下才有效。
不当的使用，将会导致有害物质泄漏的危险。

产品中有毒有害物质或元素的名称及含量

部件名称	有毒有害物质或元素					
	铅(Pb)	汞(Hg)	镉(Cd)	六价铬(Cr(VI))	多溴联苯(PBB)	多溴二苯醚(PBDE)
外壳(壳体)	×	○	○	○	○	○
电子部件(印刷电路板等)	×	○	×	○	○	○
附件(电源线、交流适配器等)	×	○	○	○	○	○

○：表示该有毒有害物质在该部件所有均质材料中的含量均在 SJ/T11363-2006 标准规定的限量要求以下。
×：表示该有毒有害物质至少在该部件的某一均质材料中的含量超出 SJ/T11363-2006 标准规定的限量要求。
因根据现有的技术水平，还没有什么物质能够代替它。



This product complies with the requirements of EMC Directive 2004/108/EC.

For EU Countries

For the USA

FEDERAL COMMUNICATIONS COMMISSION RADIO FREQUENCY INTERFERENCE STATEMENT

This equipment has been tested and found to comply with the limits for a Class B digital device, pursuant to Part 15 of the FCC Rules. These limits are designed to provide reasonable protection against harmful interference in a residential installation. This equipment generates, uses, and can radiate radio frequency energy and, if not installed and used in accordance with the instructions, may cause harmful interference to radio communications. However, there is no guarantee that interference will not occur in a particular installation. If this equipment does cause harmful interference to radio or television reception, which can be determined by turning the equipment off and on, the user is encouraged to try to correct the interference by one or more of the following measures:

- Reorient or relocate the receiving antenna.
- Increase the separation between the equipment and receiver.
- Connect the equipment into an outlet on a circuit different from that to which the receiver is connected.
- Consult the dealer or an experienced radio/TV technician for help.

This device complies with Part 15 of the FCC Rules. Operation is subject to the following two conditions:

- (1) this device may not cause harmful interference, and
- (2) this device must accept any interference received, including interference that may cause undesired operation.

Unauthorized changes or modification to this system can void the users authority to operate this equipment.
This equipment requires shielded interface cables in order to meet FCC class B Limit.

For Canada

NOTICE

This Class B digital apparatus meets all requirements of the Canadian Interference-Causing Equipment Regulations.

AVIS

Cet appareil numérique de la classe B respecte toutes les exigences du Règlement sur le matériel brouilleur du Canada.

For C.A. US (Proposition 65)

WARNING

This product contains chemicals known to cause cancer, birth defects and other reproductive harm, including lead.

For the USA

DECLARATION OF CONFORMITY Compliance Information Statement

Model Name : LVS-800
Type of Equipment : Video Mixer
Responsible Party : Roland Systems Group U.S.
Address : 425 Sequoia Drive, Suite 114, Bellingham, WA 98226
Telephone : (360) 594-4282

Information

When you need repair service, call your nearest EDIROL/Roland Service Center or authorized EDIROL/Roland distributor in your country as shown below.

ASIA

INDONESIA

PT. Citra IntiRama
JL. Cideng Timur No. 15J-15O
Jakarta Pusat
INDONESIA
TEL: (021) 632-4170

CHINA

Roland Shanghai Electronics Co.,Ltd.
5F. No.1500 Pingliang Road
Shanghai 200090, CHINA
TEL: (021) 5580-0800

**Roland Shanghai Electronics Co.,Ltd.
(BEIJING OFFICE)**
10F. No.18 3 Section Anhuaxili
Chaoyang District Beijing
100011 CHINA
TEL: (010) 6426-5050

KOREA

KOREA AVICS CO., LTD.
Unit B-2208, Woolimblue9,
#240-21, Yeomchang-dong,
Gangseo-gu, Seoul, Korea
Tel: 02-322-3264

TAIWAN

**ROLAND TAIWAN
ENTERPRISE CO., LTD.**
Room 5, 9fl. No. 112 Chung Shan
N.Road Sec.2, Taipei, TAIWAN, R.O.C.
TEL: (02) 2561 3339

SINGAPORE/ MALAYSIA

Roland Asia Pacific Sdn. Bhd.
45-1, Block C2, Jalan PJU 1/39,
Dataran Prima, 47301 Petaling Jaya,
Selangor, MALAYSIA
TEL: 3-7805-3263

CENTRAL/LATIN AMERICA

BRAZIL

Roland Brasil Ltda.
Rua San Jose, 211
Parque Industrial San Jose
Cotia - Sao Paulo - SP, BRAZIL
TEL: (011) 4615 5666

Other CENTRAL/ LATIN AMERICA

Roland Systems Group U.S.
425 Sequoia Drive Suite 114,
Bellingham, Washington,
98226 USA
TEL: 360-594-4282

EUROPE

AUSTRIA/GERMANY/ ITALY/IRELAND/ UNITED KINGDOM

EDIROL (Europe) Ltd.
Studio 3.4 114 Power Road London
W4 5PY
U. K.
TEL: (0)20 8747 5949

BELGIUM/FRANCE/ LUXEMBOURG/ SWITZERLAND/ HOLLAND/SPAIN/ PORTUGAL

Roland Iberia, S.L.
Paseo García Faria, 33-35
08005 Barcelona SPAIN
TEL: 93 493 91 00

CROATIA

ART-CENTAR
Degenova 3.
HR - 10000 Zagreb
TEL: (1) 466 8493

CZECH REP.

**CZECH REPUBLIC DISTRIBUTOR
s.r.o.**
Voctárova 247/16
CZ - 180 00 PRAHA 8,
CZECH REP.
TEL: (2) 830 20270

DENMARK

Roland Scandinavia A/S
Nordhavnsvej 7, Postbox 880,
DK-2100 Copenhagen
DENMARK
TEL: 3916 6200

FINLAND

**Roland Scandinavia As, Filial
Finland**
Elannontie 5
FIN-01510 Vantaa, FINLAND
TEL: (0)9 68 24 020

NORWAY

**Roland Scandinavia Avd.
Kontor Norge**
Lilleakerveien 2 Postboks 95
Lilleaker N-0216 Oslo
NORWAY
TEL: 2273 0074

SWEDEN

**Roland Scandinavia A/S
SWEDISH SALES OFFICE**
Danvik Center 28, 2 tr.
S-131 30 Nacka SWEDEN
TEL: (0)8 702 00 20

HUNGARY

Roland East Europe Ltd.
Warehouse Area 'DEPO' Pf.83
H-2046 Torokbalint, HUNGARY
TEL: (23) 511011

POLAND

ROLAND POLSKA SP. Z O.O.
ul. Kty Grodziskie 16B
03-289 Warszawa, POLAND
TEL: (022) 6678 9512

ROMANIA

FBS LINES
Piata Libertatii 1,
535500 Gheorgheni, ROMANIA
TEL: (266) 364 609

RUSSIA

MuTek
Dorozhnaya ul.3, korp.6
117 545 Moscow, RUSSIA
TEL: (095) 981-4967

SLOVAKIA

DAN Acoustic s.r.o.
Povazská 18.
SK - 940 01 Nové Zámky
TEL: (035) 6424 330

UKRAINE

EURHYTHMICS Ltd.
P.O.Box: 37-a.
Nedecey Str. 30
UA - 89600 Mukachevo, UKRAINE
TEL: (03131) 414-40

OCEANIA

AUSTRALIA/ NEW ZEALAND

**Roland Corporation
Australia Pty., Ltd.**
38 Campbell Avenue
Dee Why West, NSW 2099
AUSTRALIA

For Australia
Tel: (02) 9982 8266
For New Zealand
Tel: (09) 3098 715

NORTH AMERICA

CANADA

**Roland Canada Ltd.
(Head Office)**
5480 Parkwood Way, Richmond B.
C., V6V 2M4 CANADA
TEL: (604) 270 6626

Roland Canada Ltd. (Toronto Office)

170 Admiral Boulevard
Mississauga ON L5T 2N6 CANADA
TEL: (905) 362 9707

U. S. A.

Roland Systems Group U.S.
425 Sequoia Drive Suite 114,
Bellingham, Washington,
98226 USA

As of Jan. 1, 2009 (EDIROL-2)



* 5 1 0 0 0 0 9 7 0 0 - 0 1 *