

DENON

CD/USB MEDIA PLAYER & CONTROLLER

DN-S1200

Owner's Manual

SAFETY PRECAUTIONS



CAUTION
RISK OF ELECTRIC SHOCK
DO NOT OPEN



CAUTION:
TO REDUCE THE RISK OF ELECTRIC SHOCK, DO NOT REMOVE COVER (OR BACK). NO USER-SERVICEABLE PARTS INSIDE. REFER SERVICING TO QUALIFIED SERVICE PERSONNEL.

The lightning flash with arrowhead symbol, within an equilateral triangle, is intended to alert the user to the presence of uninsulated "dangerous voltage" within the product's enclosure that may be of sufficient magnitude to constitute a risk of electric shock to persons.

The exclamation point within an equilateral triangle is intended to alert the user to the presence of important operating and maintenance (servicing) instructions in the literature accompanying the appliance.

IMPORTANT TO SAFETY

WARNING:
To reduce the risk of fire and electric shock, this apparatus should not be exposed to rain or moisture and objects filled with liquids, such as vases, should not be placed on this apparatus.

European models

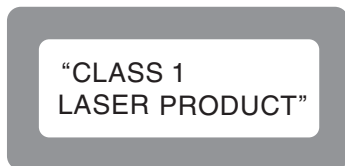

WARNING : SHOCK HAZARD - DO NOT OPEN.
AVIS : RISQUE DE CHOC ÉLECTRIQUE - NE PAS OUVRIR.

"ご注意" 機器内部にレーザー光放射装置があります。また、感電防止のためネジや蓋を外さないでください。万一故障の場合には、最寄りのサービスセンター/営業所、または、お買上げの販売店に修理をご依頼ください。

Marking sign is located on bottom of the unit.

U.S.A., Canada models

This device complies with Part 15 of the FCC Rules. Operation is subject to the following two conditions : (1) This device may not cause harmful interference, and (2) this device must accept any interference received, including interference that may cause undesired operation.

This Class B digital apparatus meets all requirements of the Canadian Interference-Causing Equipment Regulations.
Cet appareil numérique de la classe B respecte toutes les exigences du Règlement sur le matériel brouilleur du Canada.

CERTIFICATION

THIS PRODUCT COMPLIES WITH DHHS RULES 21 CFR SUBCHAPTER J APPLICABLE AT DATE OF MANUFACTURE.

D&M Holdings Inc.
2-1 NISSHIN-CHO KAWASAKI-KU, KAWASAKI-SHI KANAGAWA, 210-8569, JAPAN

WARNING : SHOCK HAZARD - DO NOT OPEN.
AVIS : RISQUE DE CHOC ÉLECTRIQUE - NE PAS OUVRIR.

"ご注意" 機器内部にレーザー光放射装置があります。また、感電防止のためネジや蓋を外さないでください。万一故障の場合には、最寄りのサービスセンター/営業所、または、お買上げの販売店に修理をご依頼ください。

Marking sign is located on bottom of the unit.

Marking sign LOCATION: BOTTOM

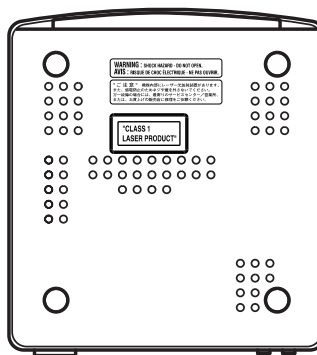

European models

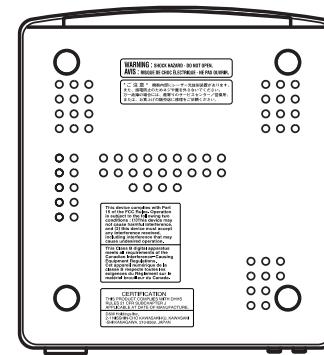

U.S.A., Canada models

IMPORTANT SAFETY INSTRUCTIONS







READ BEFORE OPERATING EQUIPMENT

This product was designed and manufactured to meet strict quality and safety standards. There are, however, some installation and operation precautions which you should be particularly aware of.

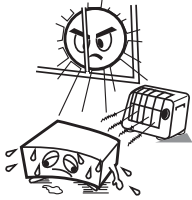
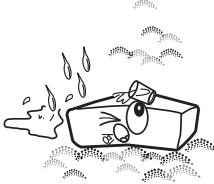
1. Read these instructions.
 2. Keep these instructions.
 3. Heed all warnings.
 4. Follow all instructions.
 5. Do not use this apparatus near water.
 6. Clean only with dry cloth.
 7. Do not block any ventilation openings. Install in accordance with the manufacturer's instructions.
 8. Do not install near any heat sources such as radiators, heat registers, stoves, or other apparatus (including amplifiers) that produce heat.
 9. Do not defeat the safety purpose of the polarized or grounding-type plug. A polarized plug has two blades with one wider than the other. A grounding type plug has two blades and a third grounding prong. The wide blade or the third prong are provided for your safety. If the provided plug does not fit into your outlet, consult an electrician for replacement of the obsolete outlet.
 10. Protect the power cord from being walked on or pinched particularly at plugs, convenience receptacles, and the point where they exit from the apparatus.
 11. Only use attachments/accessories specified by the manufacturer.
 12. Use only with the cart, stand, tripod, bracket, or table specified by the manufacturer, or sold with the apparatus.
When a cart is used, use caution when moving the cart/apparatus combination to avoid injury from tip-over.
 13. Unplug this apparatus during lightning storms or when unused for long periods of time.
 14. Refer all servicing to qualified service personnel. Servicing is required when the apparatus has been damaged in any way, such as power-supply cord or plug is damaged, liquid has been spilled or objects have fallen into the apparatus, the apparatus has been exposed to rain or moisture, does not operate normally, or has been dropped.
- Additional Safety Information!**
15. ⚡ Marked terminals are HAZARDOUS LIVE and that the external wiring connected to those terminal requires installation by an instructed person or the use of ready-made leads or cords.



NOTE ON USE / HINWEISE ZUM GEBRAUCH / OBSERVATIONS RELATIVES A L'UTILISATION / NOTE SULL'USO / NOTAS SOBRE EL USO / ALVORENSTE GEBRUIKEN / OBSERVERA ANGÅENDE ANVÄNDNINGEN

 <ul style="list-style-type: none"> • Avoid high temperatures. Allow for sufficient heat dispersion when installed in a rack. • Vermeiden Sie hohe Temperaturen. Beachten Sie, dass eine ausreichende Belüftung gewährleistet wird, wenn das Gerät auf ein Regal gestellt wird. • Eviter des températures élevées. Tenir compte d'une dispersion de chaleur suffisante lors de l'installation sur une étagère. • Evitate di esporre l'unità a temperature elevate. Assicuratevi che vi sia un'adeguata dispersione del calore quando installate l'unità in un mobile per componenti audio. • Evite altas temperaturas. Permite la suficiente dispersión del calor cuando está instalado en la consola. • Vermijd hoge temperaturen. Zorg er bij installatie in een audiorack voor, dat de door het toestel geproduceerde warmte goed kan worden afgevoerd. • Undvik höga temperaturer. Se till att det finns möjlighet till god värmeavledning vid montering i ett rack. 	 <ul style="list-style-type: none"> • Keep the unit free from moisture, water, and dust. • Halten Sie das Gerät von Feuchtigkeit, Wasser und Staub fern. • Protéger l'appareil contre l'humidité, l'eau et la poussière. • Tenete l'unità lontana dall'umidità, dall'acqua e dalla polvere. • Mantenga el equipo libre de humedad, agua y polvo. • Laat geen vochtigheid, water of stof in het apparaat binnendringen. • Utsätt inte apparaten för fukt, vatten och damm. 	 <ul style="list-style-type: none"> • Do not let foreign objects into the unit. • Lassen Sie keine fremden Gegenstände in das Gerät kommen. • Ne pas laisser des objets étrangers dans l'appareil. • Non inserite corpi estranei all'interno dell'unità. • No deje objetos extraños dentro del equipo. • Laat geen vreemde voorwerpen in dit apparaat vallen. • Se till att främmande föremål inte tränger in i apparaten. 	<p>CAUTION:</p> <ul style="list-style-type: none"> • The ventilation should not be impeded by covering the ventilation openings with items, such as newspapers, tablecloths, curtains, etc. • No naked flame sources, such as lighted candles, should be placed on the unit. • Observe and follow local regulations regarding battery disposal. • Do not expose the unit to dripping or splashing fluids. • Do not place objects filled with liquids, such as vases, on the unit. <p>ACHTUNG:</p> <ul style="list-style-type: none"> • Die Belüftung sollte auf keinen Fall durch das Abdecken der Belüftungsöffnungen durch Gegenstände wie beispielsweise Zeitungen, Tischtücher, Vorhänge o. Ä. behindert werden. • Auf dem Gerät sollten keinerlei direkte Feuerquellen wie beispielsweise angezündete Kerzen aufgestellt werden. • Bitte beachten Sie bei der Entsorgung der Batterien die örtlich geltenden Umweltbestimmungen. • Das Gerät sollte keiner tropfenden oder spritzenden Flüssigkeit ausgesetzt werden. • Auf dem Gerät sollten keine mit Flüssigkeit gefüllten Behälter wie beispielsweise Vasen aufgestellt werden.
 <ul style="list-style-type: none"> • Handle the power cord carefully. Hold the plug when unplugging the cord. • Gehen Sie vorsichtig mit dem Netzkabel um. Halten Sie das Kabel am Stecker, wenn Sie den Stecker herausziehen. • Manipuler le cordon d'alimentation avec précaution. Tenir la prise lors du débranchement du cordon. • Maneggiare il cavo di alimentazione con attenzione. Tenete ferma la spina quando scollegate il cavo dalla presa. • Maneje el cordón de energía con cuidado. Sostenga el enchufe cuando desconecte el cordón de energía. • Hanteer het netsnoer voorzichtig. Houd het snoer bij de stekker vast wanneer deze moet worden aan- of losgekoppeld. • Hantera nätkabeln varsamt. Håll i kabeln när den kopplas från el-uttaget. 	 <ul style="list-style-type: none"> • Unplug the power cord when not using the unit for long periods of time. • Wenn das Gerät längere Zeit nicht verwendet werden soll, trennen Sie das Netzkabel vom Netzstecker. • Débrancher le cordon d'alimentation lorsque l'appareil n'est pas utilisé pendant de longues périodes. • Scollegate il cavo di alimentazione quando prevedete di non utilizzare l'unità per un lungo periodo di tempo. • Desconecte el cordón de energía cuando no utilice el equipo por mucho tiempo. • Neem altijd het netsnoer uit het stopcontact wanneer het apparaat gedurende een lange periode niet wordt gebruikt. • Koppla loss nätkabeln om apparaten inte kommer att användas i lång tid. 	 <ul style="list-style-type: none"> • Do not let insecticides, benzene, and thinner come in contact with the unit. • Lassen Sie das Gerät nicht mit Insektiziden, Benzin oder Verdünnungsmitteln in Berührung kommen. • Ne pas mettre en contact des insecticides, du benzène et un diluant avec l'appareil. • Assicuratevi che l'unità non entri in contatto con insetticidi, benzolo o solventi. • No permita el contacto de insecticidas, gasolina y diluyentes con el equipo. • Voorkom dat insecticiden, benzeen of verfverdunder met dit toestel in contact komen. • Se till att inte insektsmedel på spraybruk, bensen och thinner kommer i kontakt med apparatens hölje. 	<p>ATTENTION:</p> <ul style="list-style-type: none"> • La ventilation ne doit pas être gênée en recouvrant les ouvertures de la ventilation avec des objets tels que journaux, rideaux, tissus, etc. • Aucune flamme nue, par exemple une bougie, ne doit être placée sur l'appareil. • Veuillez à respecter les lois en vigueur lorsque vous jetez les piles usagées. • L'appareil ne doit pas être exposé à l'eau ou à l'humidité. • Ne pas poser d'objet contenant du liquide, par exemple un vase, sur l'appareil. <p>ATTENZIONE:</p> <ul style="list-style-type: none"> • Le aperture di ventilazione non devono essere ostruite coprendole con oggetti, quali giornali, tovaglie, tende e così via. • Non posizionate sull'unità fiamme libere, come ad esempio candele accese. • Prestate attenzione agli aspetti legati alla tutela dell'ambiente nello smaltimento delle batterie. • L'apparecchiatura non deve essere esposta a gocciolii o spruzzi. • Non posizionate sull'unità alcun oggetto contenente liquidi, come ad esempio i vasi. <p>PRECAUCIÓN:</p> <ul style="list-style-type: none"> • La ventilación no debe quedar obstruida por haberse cubierto las aperturas con objetos como periódicos, manteles, cortinas, etc. • No debe colocarse sobre el aparato ninguna fuente inflamable sin protección, como velas encendidas. • A la hora de deshacerse de las pilas, respete la normativa para el cuidado del medio ambiente. • No exponer el aparato al goteo o salpicaduras cuando se utilice. • No colocar sobre el aparato objetos llenos de líquido, como jarras.
 <p>* (For apparatuses with ventilation holes)</p> <ul style="list-style-type: none"> • Do not obstruct the ventilation holes. • Decken Sie den Lüftungsbereich nicht ab. • Ne pas obstruer les trous d'aération. • Non coprite i fori di ventilazione. • No obstruya los orificios de ventilación. • De ventilatieopeningen mogen niet worden geblokkeerd. • Täpp inte till ventilationsöppningarna. 	 <ul style="list-style-type: none"> • Never disassemble or modify the unit in any way. • Versuchen Sie niemals das Gerät auseinander zu nehmen oder zu verändern. • Ne jamais démonter ou modifier l'appareil d'une manière ou d'une autre. • Non smontate né modificate l'unità in alcun modo. • Nunca desarme o modifique el equipo de ninguna manera. • Dit toestel mag niet gedemonteerd of aangepast worden. • Ta inte isär apparaten och försök inte bygga om den. 	<p>WAARSCHUWING:</p> <ul style="list-style-type: none"> • De ventilatie mag niet worden belemmerd door de ventilatieopeningen af te dekken met bijvoorbeeld kranten, een tafelkleed, gordijnen, enz. • Plaats geen open vlammen, bijvoorbeeld een brandende kaars, op het apparaat. • Houd u steeds aan de milieuvorschriften wanneer u gebruikte batterijen wegdoet. • Stel het apparaat niet bloot aan druppels of spatten. • Plaats geen voorwerpen gevuld met water, bijvoorbeeld een vaas, op het apparaat. <p>OBSERVERA:</p> <ul style="list-style-type: none"> • Ventilationen bör inte förhindras genom att täcka för ventilationsöppningarna med föremål såsom tidningar, bordsdukar, gardiner osv. • Inga blottade brandkällor, såsom tända ljus, får placeras på apparaten. • Tänk på miljöaspekterna när du bortskaffar batterier. • Apparaten får inte utsättas för vätska. • Placera inte föremål fyllda med vätska, t.ex. vaser, på apparaten. 	

CAUTION:

To completely disconnect this product from the mains, disconnect the plug from the wall socket outlet.

The mains plug is used to completely interrupt the power supply to the unit and must be within easy access by the user.

VORSICHT:

Um dieses Gerät vollständig von der Stromversorgung abzutrennen, ziehen Sie bitte den Stecker aus der Wandsteckdose.

Der Netzstecker wird verwendet, um die Stromversorgung zum Gerät völlig zu unterbrechen; er muss für den Benutzer gut und einfach zu erreichen sein.

PRECAUTION:

Pour déconnecter complètement ce produit du courant secteur, débranchez la prise de la prise murale.

La prise secteur est utilisée pour couper complètement l'alimentation de l'appareil et l'utilisateur doit pouvoir y accéder facilement.

ATTENZIONE:

Per scollegare completamente questo prodotto dalla rete di alimentazione elettrica, scollegare la spina dalla relativa presa a muro.

La spina di rete viene utilizzata per interrompere completamente l'alimentazione all'unità e deve essere facilmente accessibile all'utente.

PRECAUCIÓN:

Para desconectar completamente este producto de la alimentación eléctrica, desconecte el enchufe del enchufe de la pared.

El enchufe de la alimentación eléctrica se utiliza para interrumpir por completo el suministro de alimentación eléctrica a la unidad y debe de encontrarse en un lugar al que el usuario tenga fácil acceso.

WAARSCHUWING:

Om de voeding van dit product volledig te onderbreken moet de stekker uit het stopcontact worden getrokken.

De netstekker wordt gebruikt om de stroomtoevoer naar het toestel volledig te onderbreken en moet voor de gebruiker gemakkelijk bereikbaar zijn.

FÖRSIKTIGHETSÅTT:

Koppla loss stickproppen från eluttaget för att helt skilja produkten från nätet.

Stickproppen används för att helt bryta strömförsörjningen till apparaten, och den måste vara lättillgänglig för användaren.

• DECLARATION OF CONFORMITY

We declare under our sole responsibility that this product, to which this declaration relates, is in conformity with the following standards:

EN60065, EN55013, EN55020, EN61000-3-2 and EN61000-3-3.

Following the provisions of 73/23/EEC, 2004/108/EC and 93/68/EEC Directive.

• ÜBEREINSTIMMUNGSERLÄRUNG

Wir erklären unter unserer Verantwortung, daß dieses Produkt, auf das sich diese Erklärung bezieht, den folgenden Standards entspricht:

EN60065, EN55013, EN55020, EN61000-3-2 und EN61000-3-3.

Entspricht den Verordnungen der Direktive 73/23/EEC, 2004/108/EC und 93/68/EEC.

• DECLARATION OF CONFORMITE

Nous déclarons sous notre seule responsabilité que l'appareil, auquel se réfère cette déclaration, est conforme aux standards suivants:

EN60065, EN55013, EN55020, EN61000-3-2 et EN61000-3-3.

D'après les dispositions de la Directive 73/23/EEC, 2004/108/EC et 93/68/EEC.

• DICHIARAZIONE DI CONFORMITÀ

Dichiariamo con piena responsabilità che questo prodotto, al quale la nostra dichiarazione si riferisce, è conforme alle seguenti normative:

EN60065, EN55013, EN55020, EN61000-3-2 e EN61000-3-3.

In conformità con le condizioni delle direttive 73/23/EEC, 2004/108/EC e 93/68/EEC.

QUESTO PRODOTTO E' CONFORME

AL D.M. 28/08/95 N. 548

• DECLARACIÓN DE CONFORMIDAD

Declaramos bajo nuestra exclusiva responsabilidad que este producto al que hace referencia esta declaración, está conforme con los siguientes estándares:

EN60065, EN55013, EN55020, EN61000-3-2 y EN61000-3-3.

Siguiendo las provisiones de las Directivas 73/23/EEC, 2004/108/EC y 93/68/EEC.

• EENVORMIGHEIDSVERKLARING

Wij verklaren uitsluitend op onze verantwoordelijkheid dat dit product, waarop deze verklaring betrekking heeft, in overeenstemming is met de volgende normen:

EN60065, EN55013, EN55020, EN61000-3-2 en EN61000-3-3.

Volgens de bepalingen van de Richtlijnen 73/23/EEC, 2004/108/EC en 93/68/EEC.

• ÖVERENSSTÄMMELSESINTYG

Härmed intygas helt på eget ansvar att denna produkt vilken detta intyg avser, uppfyller följande standarder:

EN60065, EN55013, EN55020, EN61000-3-2 och EN61000-3-3. Enligt stadgarna i direktiv 73/23/EEC, 2004/108/EC och 93/68/EEC.

A NOTE ABOUT RECYCLING:

This product's packaging materials are recyclable and can be reused. Please dispose of any materials in accordance with the local recycling regulations.

When discarding the unit, comply with local rules or regulations.

Batteries should never be thrown away or incinerated but disposed of in accordance with the local regulations concerning battery disposal.

This product and the supplied accessories, excluding the batteries, constitute the applicable product according to the WEEE directive.



HINWEIS ZUM RECYCLING:

Das Verpackungsmaterial dieses Produktes ist zum Recyceln geeignet und kann wieder verwendet werden. Bitte entsorgen Sie alle Materialien entsprechend der örtlichen Recycling-Vorschriften.

Beachten Sie bei der Entsorgung des Gerätes die örtlichen Vorschriften und Bestimmungen.

Die Batterien dürfen nicht in den Hausmüll geworfen oder verbrannt werden; bitte entsorgen Sie die Batterien gemäß der örtlichen Vorschriften.

Dieses Produkt und das im Lieferumfang enthaltene Zubehör (mit Ausnahme der Batterien!) entsprechen der WEEE-Direktive.

UNE REMARQUE CONCERNANT LE RECYCLAGE:

Les matériaux d'emballage de ce produit sont recyclables et peuvent être réutilisés. Veuillez disposer des matériaux conformément aux lois sur le recyclage en vigueur.

Lorsque vous mettez cet appareil au rebut, respectez les lois ou réglementations en vigueur.

Les piles ne doivent jamais être jetées ou incinérées, mais mises au rebut conformément aux lois en vigueur sur la mise au rebut des piles.

Ce produit et les accessoires inclus, à l'exception des piles, sont des produits conformes à la directive DEEE.

NOTA RELATIVA AL RICICLAGGIO:

I materiali di imballaggio di questo prodotto sono riutilizzabili e riciclabili. Smaltire i materiali conformemente alle normative locali sul riciclaggio.

Per lo smaltimento dell'unità, osservare le normative o le leggi locali in vigore.

Non gettare le batterie, né incenerirle, ma smaltirle conformemente alla normativa locale sui rifiuti chimici.

Questo prodotto e gli accessori inclusi nell'imballaggio sono applicabili alla direttiva RAEE, ad eccezione delle batterie.

ACERCA DEL RECICLAJE:

Los materiales de embalaje de este producto son reciclables y se pueden volver a utilizar. Disponga de estos materiales siguiendo los reglamentos de reciclaje de su localidad.

Quando se deshaga de la unidad, cumpla con las reglas o reglamentos locales.

Las pilas nunca deberán tirarse ni incinerarse. Deberá disponer de ellas siguiendo los reglamentos de su localidad relacionados con los desperdicios químicos.

Este producto junto con los accesorios empaquetados es el producto aplicable a la directiva RAEE excepto pilas.

EEN AANTEKENING MET BETREKKING TOT DE RECYCLING:

Het inpakmateriaal van dit product is recycleerbaar en kan opnieuw gebruikt worden. Er wordt verzocht om zich van elk afvalmateriaal te ontdoen volgens de plaatselijke voorschriften.

Volg voor het wegdoen van de speler de voorschriften voor de verwijdering van wit- en bruingoed op.

Batterijen mogen nooit worden weggegooid of verbrand, maar moeten volgens de plaatselijke voorschriften betreffende chemisch afval worden verwijderd.

Op dit product en de meegeleverde accessoires, m.u.v. de batterijen is de richtlijn voor afgedankte elektrische en elektronische apparaten (WEEE) van toepassing.

OBSERVERA ANGÅENDE ÅTERVINNING:

Produktens emballage är återvinningsbart och kan återanvändas. Kassera det enligt lokala återvinningsbestämmelser. När du kasserar enheten ska du göra det i överensstämmelse med lokala regler och bestämmelser.

Batterier får absolut inte kastas i soporna eller brännas. Kassera dem enligt lokala bestämmelser för kemiskt avfall.

Denna apparat och de tillbehör som levereras med den uppfyller gällande WEEE-direktiv, med undantag av batterierna.

CAUTION:

1. Handle the power supply cord carefully

Do not damage or deform the power supply cord. If it is damaged or deformed, it may cause electric shock or malfunction when used. When removing from wall outlet, be sure to remove by holding the plug attachment and not by pulling the cord.

2. Do not open the rear cover

In order to prevent electric shock, do not open the top cover. If problems occur, contact your DENON DEALER.

3. Do not place anything inside

Do not place metal objects or spill liquid inside the system. Electric shock or malfunction may result.

Please, record and retain the Model name and serial number of your set shown on the rating label.







Model No. DN-S1200

Serial No. _____

NOTE:

This CD player uses the semiconductor laser. To allow you to enjoy music at a stable operation, it is recommended to use this in a room of 5 °C (41 °F) –35 °C (95 °F).



- Use compact discs that include the  mark. CD's with special shapes (heart-shaped CD's, octagonal CD's etc.) cannot be played on this set. Attempting to do so may damage the set. Do not use such CD's.
- Benutzen Sie Compact Discs, die das  Zeichen tragen. Speziell geformte CD's (herzförmige CDs, achteckige CDs, usw.) können auf dieser Anlage nicht abgespielt werden. Der Versuch derartige CDs abzuspielen kann die Anlage beschädigen. Verzichten Sie auf die Benutzung solcher CDs.
- Utiliser des disques compacts portant le logo . Des CD avec des formes spéciales (CD en forme de cœur, des CD octogonaux, etc.) ne peuvent pas être lus sur cet appareil. Le fait de l'essayer, risque d'endommager le lecteur. Ne pas utiliser de tels CD.
- Utilizzare compact disc contrassegnati con . Non è possibile eseguire in questa unità CD con forme speciali (CD a forma di cuore, ottagonali, ecc.), poiché possono danneggiare il prodotto. Non utilizzare tali CD.
- Use discos compactos con la marca . En este equipo no es posible reproducir CDs con formas especiales (CDs con forma de corazón, CDs octogonales, etc.). Si intenta hacerlo, el equipo podrá resultar dañado. No use este tipo de CDs.
- Gebruik compact discs voorzien van het logo . CD's met speciale vormen (bijv. CD's in de vorm van een hart, achthoekige CD's, enz.) kunnen met dit toestel niet worden afgespeeld. Wanneer u dit toch probeert, zal u het toestel beschadigen. Speel dergelijke CD's dus niet af.
- Använd CD-skivor med -märket. Specialformade CD-skivor (hjärtformade, åttkantiga, m m) går inte att spela på den här apparaten. Utrustningen kan skadas om du försöker göra detta. Använd inte CD-skivor av denna typ.

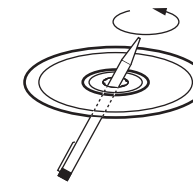
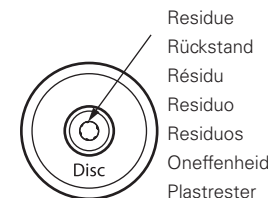

- The disc may not play normally if there is residue along the edges of the center hole.
- When using new discs in particular, use a pen, etc., to remove the residue.
- Die Disk kann nicht normal abgespielt werden, wenn sich ein Rückstand entlang der Mittellochenden befindet.
- Insbesondere, wenn Sie neue Disks benutzen, dann entfernen Sie mit einem Stift, etc. den Rückstand.
- Le disque peut ne pas être lu normalements s'il y a un résidu le long des bord du trou central.
- Lors de l'utilisation de nouveaux disques en particulier, utiliser un stylo à bille, etc., pour enlever le résidu.
- Il disco non viene eseguito in modo corretto se sono presenti residuo ai bordi del foro centrale.
- Quando si utilizzano dischi nuovi, utilizzare una penna o uno strumento simile, per rimuovere i residui.
- El disco no puede ser reproducido normalmente debido a la terminación deficiente de los bordes del agujero central.
- Para quitar estos residuos de material, especialmente cuando vaya a reproducir discos nuevos, utilice un bolígrafo, o algo similar.
- Het is mogelijk dat de disc niet normaal wordt weergegeven als de randen van het middengat van de schijf oneffenheden vertonen.
- Verwijder vooral bij gebruik van nieuwe discs de oneffenheden met een pen of iets dergelijks.
- Det kan uppstå fel vid CD-avspelningen om det finns plastrester kvar i mitthålet.
- Tänk på att bort dessa med en penna, e d, särskilt om CD-skivan är ny.

Contents

Getting Started

Accessories	1
Main Features	2
Part Names and Functions	3
Top Panel	3, 4
Front Panel	5
Rear Panel	5
Display	6

Connections

Connections	7
About Connected Devices	8
Switching the Device	8

Playback

Selecting the Track on the CD to be Played	9
Selecting the Track to be Played by USB	9, 10
File Playback Mode	11
Searching Procedure	11
Searching by Folder Name	12
Playlist Play Mode	12
Text Search	13

Basic Operations

Operations	14, 15
Next Track Function (CD/USB)	16
Scratch	16
Seamless Loop/Hot Start/Stutter	17
Seamless Loop Playback/Hot Start Playback/Stutter Playback	17
A/B Trim	18
Auto BPM Counter	18
Effector	19
Echo/loop Parameter Setting	19
Flanger Parameter Setting	19
Filter Parameter Setting	20
Platter Effects	20
Brake Operating Time Setting	20
Operating the Brake	20
Dump Play	21
Reverse Play	21

Memo Function (Custom Setting Memory)

About Memo	22
Memo Mode Select	22, 23
About Character Input	23
Character Input Using the Keyboard	23

Utility

Utilitymode	24
DB Create	24
Setting the Database Edit Mode	24
Creating Databases	24
Creating Temporary Databases	24
Preset Data	25
Preset Data mode	25
Preset Import (Importing Preset Data)	25
Preset Export	25
Memo Data	25
Memo Data mode	25
Memo Import (Importing Memo Data)	25
Memo Export (Exporting Memo Data)	26
Initialize	26
Initialize Mode	26
USB Format (Formatting External USB Memory Devices)	26
S1200 Init.	26
Preset	27
Preset Mode	27
Items and Data that can be Preset	27, 28
Compatible Files	28

Specifications	29
-----------------------------	----

Getting Started

Accessories

Check that the following parts are supplied with the product.

① Owner's manual	1
② CD-ROM	1
③ Connection cords for signal output (RCA)	1
④ Warranty (for North America model only)	1

Main Features

1. External USB Device Support

The DN-S1200 can support external USB mass storage class devices. Connect your, iPod®, Thumb Drive, and large Hard Drives for easy access to your small or extensive mp3/wav libraries up to 50,000 files. Simply plug these devices into the DN-S1200 to obtain the powerful on-board features such as, Instant Start, Seamless Looping, Scratching and easy File Searching to name a few.

※ Only mass storage class compatible iPods are supported.

2. MIDI Interface Controller (PC/MAC)

The DN-S1200 is also designed to interface & control a variety of popular DJ programs that supports USB MIDI in/out interface, either by user custom mapping or direct native support by the software vendor. Control your favorite DJ software all from one clever compact player.

※ Supported Platforms: Mac OSX 10.4 or Higher, Windows XP SP2, Windows Vista

3. Internal 24-Bit Processing & USB Audio

Unlike most dedicated DJ midi controllers that are only USB bus powered, the DN-S1200 encompasses its own internal power supply to achieve the highest electrical specifications, resulting in best possible performance. The DN-S1200 features industry leading Burr Brown (a product of TI) 24 bit DAC processing for superior output audio fidelity.

USB Audio interface includes Stereo output pair, 44.1kHz sampling range and low latency ASIO / OSX Core Audio support.

※ ASIO Driver included on installation CD-ROM

4. Multi Functional Touch Sensitive Scratch disc

The 120 mm Scratch disc is constructed with an ultra high-resolution pulse and touch sensor mechanism to accurately reproduce the most subtle or swift scratching movements made by the human hand. The Scratch disc can perform other vital functions too such as, pitch bending, scanning, file searching and dry/wet control for effects.

5. 4 Superb Built-in Effects

Building the mood of your dance floor and remixing live has never been so easy with our on-board effects. Easily activate and have full parameter control with a Dry/Wet mix control of the 4 effects: Flanger, Filter (High-Mid-Low), Echo and worlds first Echo/Loop.

6. 3 Platter Effects

- Brake (adjustable in real-time)
- Dump (reverse sound without losing true forward time, like a radio edit)
- Reverse (plays your music backwards)

7. Hot Starts & Seamless Looping

Two Hot Starts (**A1** button and **A2** button) can be made on the fly and easily turned into Seamless Loops.

8. Loop A/B Trim

The A or B point for the seamless loops can be easily adjusted on-the-fly to perfection.

9. Next track function with cross fading

The next track can be searched for in various ways without stopping playback and the track the user has searched for is cross-faded seamlessly.

※ The user adjusts the cross fading time.

10. Quick Jump

We made searching fast & easy. You can now jump around within a track/file by precise user adjustable increment time steps.

11. 2-way Pitch Bend

2-way pitch bending is performed by pressing the **JOG MODE** button, switching the jog mode to "BEND/Search" then turning the Scratch or pressing the **PITCH BEND +/-** button.

12. 4-Way BPM Counter

- Auto Beat Detection
- Manual TAP
- Manual BPM Input
- Reads MP3/WAV BPM Metadata from USB device (if available)

13. Memo function

Cue point, BPM, Pitch Setting & Range, Pitch ON/OFF, Key Adj ON/OFF, and Seamless Loop A and B data can be stored directly to the file for later recall. In addition, CD memo data can be exported to USB memory and shared with other DN-S1200 players.

14. Key Adjust

The Key Adjust feature keeps vocals and music sounding true even when you adjust the speed of the track or file.

15. PS/2 Keyboard Support & Intuitive File Navigation System

3-types of global PS/2 keyboards are supported (Qwerty, Qwertz, Azerty) in 9 different native languages for simplified song search of; Artist, Album, Title, Genre, Year, BPM & File Name. In addition, shortcut keys are assigned to perform various functions. In addition, a single keyboard can be shared in a 2-deck configuration by the D-Link connection.

16. Vibrant Tube Display w/ 2-line Character Text Support

Another unique quality of the DN-S1200 is its informative & animated tube display. The display offers two lines of character information to quickly navigate through your CD TEXT tracks and USB files. A visual 32-position Marker Point indicator follows your hand movements at lighting speeds without drift. Other indicators include Looping, Hot Starts, BPM info, Elapsed/Remain Time, MP3/WAV file types, and other useable indicators.

17. Two Way CUE Search System

Supports traditional Denon Cueing method and another popular style as well.

18. Power On Play

Unattended playback is possible upon power up. Great for restaurants, bars and nightclubs at opening time.

19. Relay Play

Unattended playback is possible between two players by the D-Link connection. Great for the cocktail hour or during dinner time at banquet halls.

20. Fader Start

Supports traditional Fader Start, including all Denon Mixers.

21. Digital Output

Digital signals are always output at 44.1 kHz, with no restrictions on the mode, playing speed, etc.

22. Software Upgradeable by USB

From time to time we will make subtle improvements to current features or add new compelling ones based on valuable user feedback. These new Plug Ins are always free and made available via our www.denondj.com website.

Part Names and Functions

For buttons not explained here, see the page indicated in parentheses ().

Top Panel



Note that there are many buttons working two different function selected by short time pushing or long pushing (1 second or more). The “.” mark indicates short time push function and “-” mark indicates long time push function.

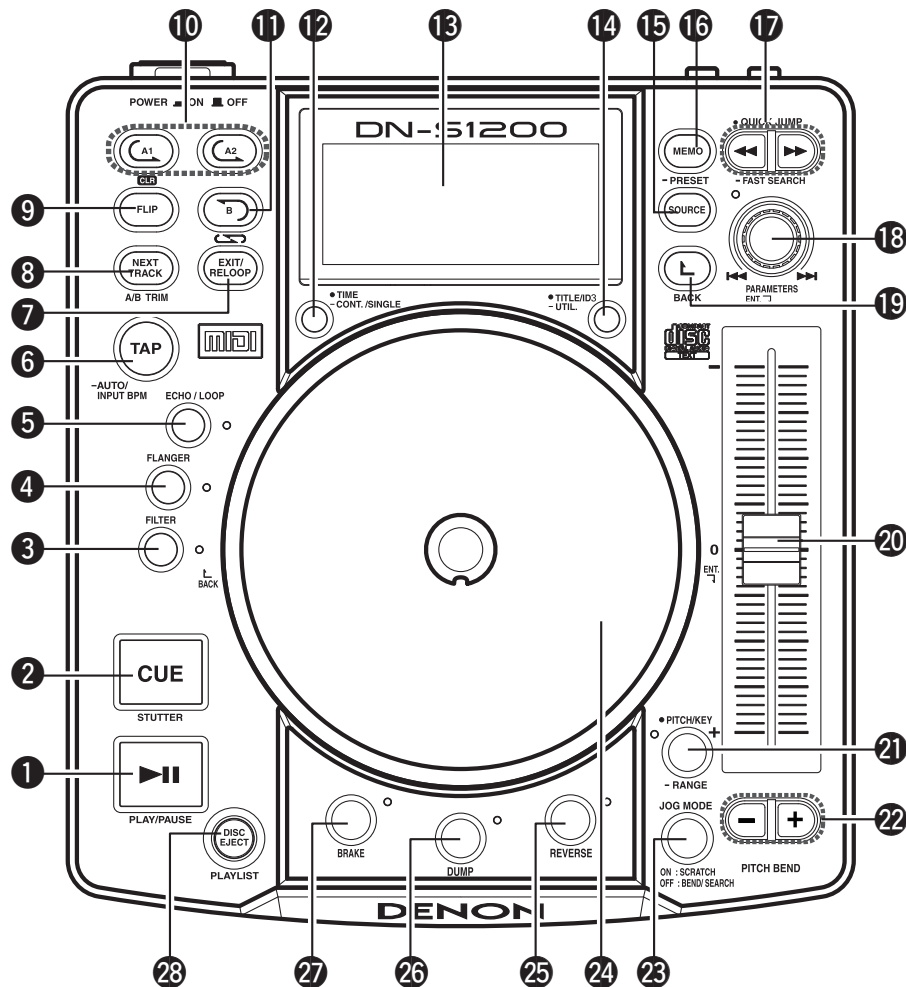

1 PLAY/PAUSE button (▶ ||)

- This button will start or pause playback.
- Push once to start playback, once again to pause playback, and once more to resume playback.

2 CUE/STUTTER button

- CUE (Back cue):
Pushing this button in play mode will force the file back to the position which playback started. While in search mode, it makes new Cue point.
- Stutter:
In Cue mode, by pushing the **CUE** button makes a Stutter sound from the Cue point. This is called Stutter play.

3 FILTER button

- One of three filters (LOW PASS, MID PASS and HIGH PASS) can be selected.

4 FLANGER button

- The depth and delay time can be selected.

5 ECHO/LOOP button

- The ECHO and LOOP functions can be selected. The feedback level and delay time can be selected. Looping for the delay time (ECHO LOOP) is possible by setting the feedback level to “MAX”.

6 TAP, LOCK, -AUTO/INPUT BPM button

- TAP:
When you push this button repeatedly, the Auto mode turns off and starts measuring your Beats Per Minute (BPM) by tapping.
- BPM LOCK:
When this button is pressed once while the Auto BPM counter is operating, the data measured by the Auto BPM counter is locked.
- AUTO:
When pushing the **TAP** button for 1 second, activates AUTO BPM mode. The measured BPM is displayed in the character section of the display.
- MANUAL INPUT:
When the **TAP** button is pressed and held in for more than 2 seconds, the BPM input mode is set and the BPM value can be input directly with the **PARAMETERS** knob. When the **TAP** button is pressed again, the BPM input mode is turned off.

NOTE

- If you select a new file, AUTO BPM mode turns on automatically.
- BPM data can be saved to the MEMO function.

7 EXIT/RELOOP button

Use this to exit or return back again to Seamless loop playback. You can add variety to looping with this function.

8 NEXT TRACK button, A/B TRIM buttons

When the button is pressed during playback, the next track mode is selected. When pressed during seamless looping, the mode for adjusting seamless loop point A or B is set, and when pressed again, the next track is set.

9 FLIP/CLR button

- FLIP:
Use this to select operating mode of **A1** and **A2** buttons, from Hot Start mode and Stutter mode. The display will indicate “H/S” or “STR”.
- A1, A2 CLR:
If the **A1** or **A2** buttons is pushed while pushing the **FLIP** button, you can clear the selected A point.
By holding down just the **FLIP** button for more than 1 sec, you can clear A1 and A2 points all at once.

10 A1, A2 button

Using this button you can create starting point for Hot Start, Seamless Loop and Stutter.

11 B button

Use this to set the B point for to create a Seamless Loop after the A point has been set.

12 TIME button, -CONT./SINGLE button

- TIME:
The display switches between “ELAPSED” (elapsed time), “REMAIN” (remaining time), “TELAPSED” (total elapsed time) and “T.REMAIN” (total remaining time) each time the button is pressed.

NOTE

It is not possible to switch the total elapsed time and total remaining time when searching for files in the USB mode.

- CONT./SINGLE:
The display switches between the single play mode (PLAY LOCK), single play mode (LOCK OFF) and continuous play each time the button is pressed and held in for over 1 second.
- CONT. (Continuous play mode)
Playback continues through the end of the last file.
- SINGLE (Single play mode)
The currently playing file is played to the end.
- SINGLE PLAY LOCK (Single play & play lock)
“Single play & play lock” can be selected in the “PRESET” settings. When “Single play & play lock” is selected, the single play mode is set. In this mode, files cannot be selected during playback, thus preventing files from being selected or playback stopped accidentally.

13 Display

14 TITLE/ID3 button, -UTILITY button

- TITLE:
CD mode..... Each time the button is pressed when there is CD text data, the display switches between the “Artist”, “Album”, “Title” and the display shown before the display was switched.
- USB mode..... When the button is pressed while in the USB mode, the display switches between the “Artist”, “Album”, “Title”, “Genre”, “Year” and the display shown before the display was switched.
- UTILITY:
The Utility mode is set when this button is longpressed while the player is in the Cue mode.

15 SOURCE button

When this button is pressed, the source selection screen is displayed.

16 MEMO, -PRESET button

- MEMO:
Various settings such as Cue Point, Hot Starts, Loops, BPM, Pitch and Key Adjust can be saved for later recall.
- PRESET:
When this button is pushed for more than 1 sec, the PRESET mode menu is displayed. The machine status must be in CUE, PAUSE or No Disc mode before entering the preset mode.

17 QUICK JUMP button, -FAST SEARCH button (◀◀) (▶▶)

- QUICK JUMP:
The play position jumps backward when the (◀◀) button is pressed and immediately released.
The play position jumps forward when the (▶▶) button is pressed and immediately released.
- FAST SEARCH:
When one of these buttons is pressed and held in, the disc is fast-searched in the reverse (◀◀) or forward (▶▶) direction.

18 PARAMETERS knob

- PARAMETERS:
When the **PARAMETERS** knob is turned, the platter effect, memo, preset or other parameters and data can be selected.
- FILE SEARCH:
When the **PARAMETERS** knob is turned while pressing it, the letter search mode is set.
- TRACK SEARCH, Playlist, FILE SEARCH:
When the **PARAMETERS** knob is pressed, tracks (files) can be selected one track at a time.
When the **PARAMETERS** knob is turned while pressing it, tracks (files) can be selected in units of 10.

19 BACK button

- Press this button to return to the previous screen.
- A long-press shall return to the top menu.

20 PITCH SLIDER

Use this slider to adjust playing speed. The playing speed decreases when slid upwards and increases downwards.

21 PITCH/KEY, -RANGE:

- PITCH/KEY:
The mode switches between pitch on, key adjust on and pitch off each time the button is pressed and released immediately. The indicator lights when in the pitch on and key adjust on modes.
- RANGE:
Push this button for more than 1 sec to select the pitch range. The pitch range can be selected with the **PARAMETERS** knob from ±4, 10, 16, 24, 50 or 100 %.

22 PITCH BEND +/- buttons

- Pushing these buttons will change main playing speed temporarily.
- While pushing **PITCH BEND +** button the playing speed increases and speed decreases while pushing **PITCH BEND -** button.
- When release button, playing speed returns to the previous speed.

23 JOG MODE button

When this button is pressed, the Scratch disc operation mode can be selected.

- SCRATCH:
The button lights orange during scratch playback.
- BEND/SEARCH:
When the PLATTER Source is set to BEND during playback, it alternates as the pitch bend function. The display will indicate “Bend”. When PLATTER Source is set to Search, during Pause or CUE mode, it alternates as the Manual Search function. Manual search allows you to move the CUE point around by one frame at a time (1/75 second) with an audible frame-repeat sound. The display will indicate “Search”.

24 Scratch disc

The scratch playback, manual search, pitch bend and effector parameters can be selected. In the file search mode, the file can be selected.

25 REVERSE button

Push this button to set the REVERSE.

26 DUMP button

Push this button to set the DUMP.

27 BRAKE button

Push this button to set the BRAKE and adjust the parameter.

28 PLAYLIST, DISC EJECT button

- PLAYLIST:
The mode switches between file search and playlist search each time this button is pressed in the USB play mode. When pressed while in a mode other than USB play, the mode switches between the search mode and the playlist search mode each time the button is pressed.
- DISC EJECT:
When the button is pressed, the CD is ejected. Ejection is locked while a CD is playing. During USB playback, the disc is ejected when the **DISC EJECT** button is pressed for over 1 second.

Front Panel

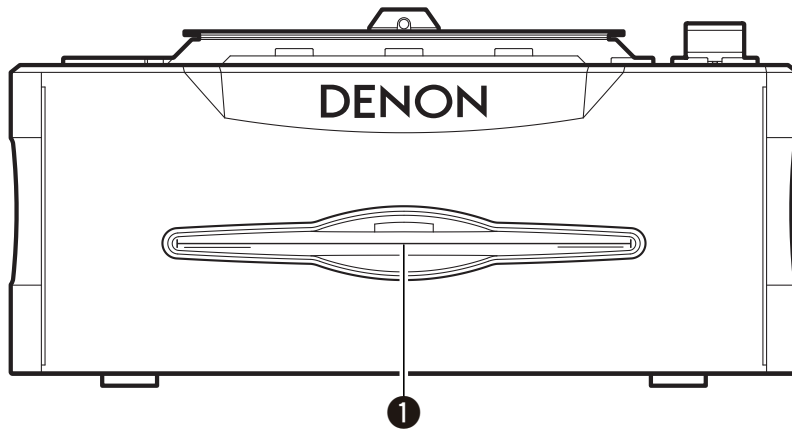

1 Disc loading slot

Insert CDs here. Insert the CD slowly, then release it.

Rear Panel

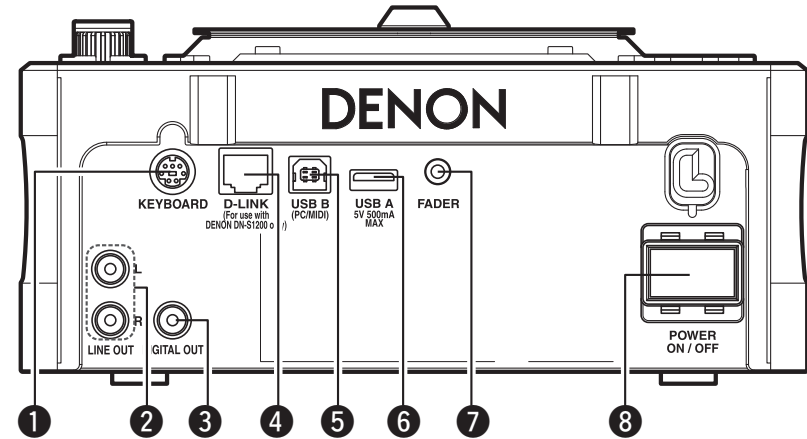

1 PS/2 connector

Terminal for connecting a PS/2 keyboard.

2 Analog output terminals (LINE OUT)

- This is unbalanced RCA output terminals.
- Audio signals outputs.

3 Digital output terminal (DIGITAL OUT)

- Digital data is available from these terminals.
- Use 75 Ω /ohms pin cord for connection.
- We recommend you use braided wire type shielded cable.

NOTE

The playback level after analog conversion is set to -6 dB below the usual level to avoid digital distortion.

4 D-Link connector

Terminal for connecting another DN-S1200.

Exchange of memo data, keyboard data and relay command information is performed with another DN-S1200.

※ Do not connect anything other than a DN-S1200.

※ Use an RJ45 cross cable no longer than 3 meters for connection.

5 USB B port

- USB MIDI and HID commands are sent from the DN-S1200 to the computer.
- USB MIDI and HID commands as well as USB AUDIO signals are received from the computer.

6 USB A port

Only one mass storage device (USB memory, USB HDD, etc.) can be connected.
 ※ Not compatible with USB hubs

7 Fader start jack

• Connect the mixer here.

The various fader commands (play, pause, cue, etc.) are received from the mixer.

• Use a 3.5 mm stereo mini cord for connection.

8 POWER button

Push this button to turn power on and off.

NOTE

Do not turn off the power while a disc is loading or ejecting. Doing so could damage the CD mechanism and lead to malfunction.

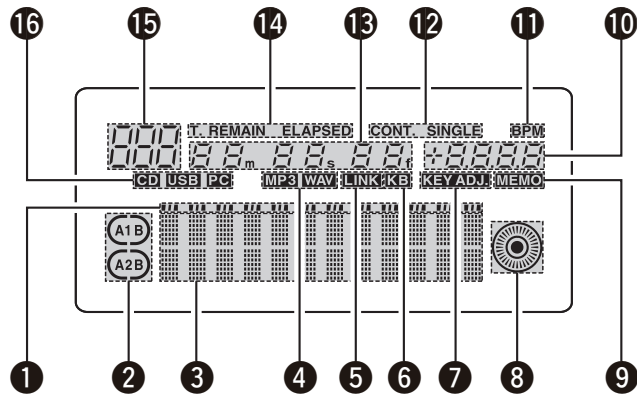

1 Play position indicator

The position of playback is indicated by the elapsed time, in white when in the normal play mode, in orange when in the reverse play mode.

When the time to the end of the track (file) is less than the specified time, the play position indicator flashes according to the remaining track time (EOM) to indicate the end of the track (file).

or Left arrow only on:

Hot Start mode

Both arrows on:

Seamless Loop mode

, Both arrows flashing:

Seamless Loop Playing

, Left arrow on, right flashing:

Exit play from Seamless Loop

2 Loop mode indicators

DN-S1200 has Loop mode indicators which consist of A, B and two arrows.

A and B marks indicate A and B points have been set.

Two arrows indicate loop setting mode as follows.

3 Character display section

With the DN-S1200, mode selection and other operations can be performed following the character display and using the **PARAMETERS** knob.

The **PARAMETERS** indicator flashes when data can be entered using the **PARAMETERS** knob.



The character display section indicates the operation, mode name, data, etc. ">> ↵" is indicated at the side of the displayed data. When ">> ↵" is flashing, this indicates that the item at that row is selected.

4 File data indicator

This indicates the file's format.

5 D-Link connection confirmation indicator

This lights when D-Link connection has been confirmed.

6 Keyboard connection indicator

Deck for which keyboard is effective is now displayed.

7 KEY ADJ. indicator

KEY ADJ. indicator appears in display when the Key Adjust mode is ON.

8 Scratch marker

This turns according to the playing status of the different decks.

Use this as an indicator for scratching and other JOG operations.

9 MEMO indicator

This indicates whether or not there is memo data.

When in the play or standby mode, the "MEMO" indicator lights if there is memo data for the current track. In the playlist search mode in the USB mode, the indicator flashes if there is memo data for the selected playlist.

In the CD mode when D-Link is possible, the "MEMO" indicator flashes if data is stored in the USB memory connected to the other DN-S1200.

10 Pitch display

This indicator display the playback speed (pitch).

11 BPM indicators

Lights when the BPM is displayed on the pitch display.

12 Play mode indicators

When "SINGLE" indicator lights up, playback will finish at end of current file.

When "CONT." indicator lights up, playback continues.

13 Minute, second and frame displays

These displays indicate current position information.

14 Time mode indicators

When the **TIME** button is pushed, the Time mode indicator switches as follows.

ELAPSED: File's elapsed time is displayed.

REMAIN: File's remaining time is displayed.

T. ELAPSED: The total elapsed time of Playlist is displayed.

T. REMAIN: The total remaining time of Playlist is displayed.

15 Track indicator

The number of the currently playing track is displayed here when in the playlist or CD mode.

16 SOURCE display

This displays the device currently selected for the different decks.

Connections

Connections

1. Turn off the POWER switch.
2. Connect the RCA pin cords to the inputs on your mixer.
3. If the mixer has a fader output terminal, connect the mixer and the DN-S1200's fader input terminal with a 3.5 mm stereo mini cord. Fader control of the DN-S1200 is possible.

NOTE

- Be sure to use the supplied control cord. Using another type of cable may result in damage.
- Connect the USB mass storage device to the component to be played.
- When operating the DJ software in the MIDI mode, connect the various components to be used directly to the computer.

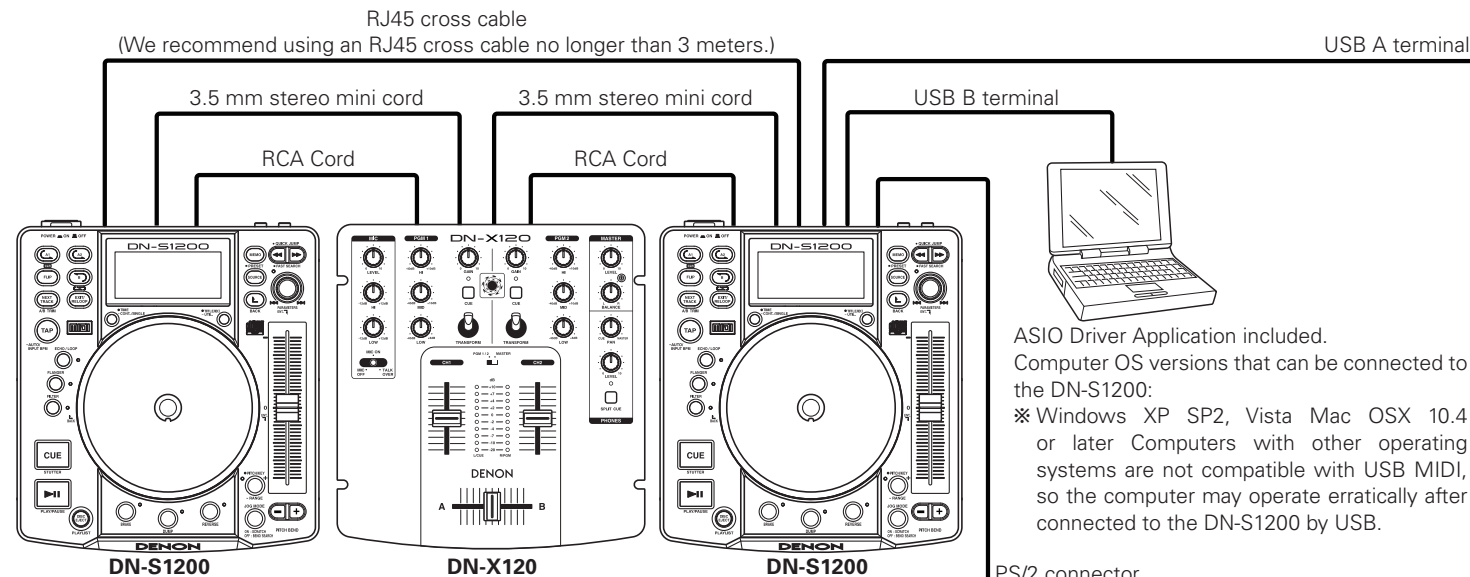

Functions that can be used when connected by D-Link

- Relay Play
- Memo Link
- Keyboard switching

NOTE

Some USB Keyboards will work if used with a PS/2 connector/adaptor.

USB mass storage device



- ※ The DN-S1200 is not compatible with USB hubs.
- ※ When playing on the DN-S1200, create the database in the utility mode or using the included DENON DJ Music Manager.

About Connected Devices

1. PS/2 Keyboard

- ① Qwerty, Qwertz, Azerty type keyboard layouts are supported.
- ② The DN-S1200 can be operated from the keyboard.
For the usable keys and their functions, refer to the table below.

	Keyboard	DN-S1200 Front Panel Button
1	↓	PARAMETERS knob (Scroll Up)
2	↑	PARAMETERS knob (Scroll Down)
3	ENTER	Pushing PARAMETERS knob
4	ESC	BACK button
5	Shift+TAB	Connects by D-Link and switches to functions operable from the keyboard.
6	INSERT	SOURCE button
7	Windows	PLAYLIST button
8	ALT	NEXT TRACK button
9	F1	TIME button
10	F2	TITLE button
11	F3	TIME button (Press and hold in)
12	F12	Switches the number of steps for file searching.

NOTE

Keys (characters) other than the ones on the above table are used when inputting characters. For a list of the characters that can be used, see the section called "About Character Input" (📖 page 23).

2. USB mass storage device

- ① Operation of the USB device may be unstable when using the bus power only.
- ② If the USB device is not recognized, it might be recognized if it is disconnected then reconnected.
- ③ Devices on which power is supplied from the device to the host equipment side in a way not conforming to USB standards could damage the host equipment. Do not use such devices.
- ④ Do not disconnect a USB device when it is selected to be operated by the DN-S1200 or when the database is being created. Disconnecting while the device is being accessed could damage files, etc.
- ⑤ For large capacity USB devices and USB devices that are not specifically designed for data storage (MP3 players, etc.), it may take some time for the device to be recognized after it is connected to the DN-S1200.

- ⑥ Use a USB memory device meeting or in conformity with the USB Compliance Test.
- ⑦ The DN-S1200 is not compatible with USB hubs.
- ⑧ The DN-S1200 is compatible with FAT16 and FAT32.

3. iPod®

- ① Only Windows format iPods® can be used. Macintosh format iPods® cannot be used.
 - ② MP3/WAV files transferred from iTunes® to an iPod® are read-only files, so the MEMO function cannot be used with them.
 - ③ In iTunes®, place a check mark at "Manually manage music" in "Summary" – "Options".
 - ④ MP3/WAV files transferred from iTunes® to an iPod® are managed with iPod's® specific file names, so it is not possible to search using the original file names.
We recommend searching using ID3 tags (artist, album, title, genre, year, BPM, etc.).
- ※ iPod® and iTunes® are trademarks or registered trademarks of Apple Computer, Inc.

4. Others

- ① With the DN-S1200, the software can be updated using a USB device, but note that some time may be required for the device to be recognized.
- ② Do not use cables other than those conforming to USB standards. Using modified USB cables could damage the DN-S1200.
- ③ If there is a large number of files stored in folders on the device, searching may take some time and operation may be unstable. Keep the number of files per folder to under 1000.

Switching the Device

The device being played can be switched.
CD is first selected when the power is turned on.
The operation procedure is described below.

1 Press the **SOURCE** button.

The "SOURCE" selection screen is displayed.



2 Turn the **PARAMETERS** knob or Scratch disc to select the device.

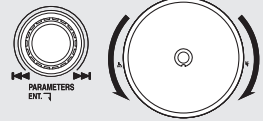

3 Press the **PARAMETERS** knob to set.

※ Operation is possible once the device is prepared.

When "CD" is selected:

The CD can be played.

When "USB" is selected:

The USB can be played.

When "PC" is selected:

The USB MIDI control mode is set.



About the USB MIDI control mode

When multiple DN-S1200s are connected to this set, change the "PRESET" – "(24) MIDI CH Set" setting to a different number (📖 page 27).

USB Audio

The USB Audio interface is compatible with one set of stereo outputs and a sampling frequency of 44.1 kHz.
The DN-S1200 supports low latency ASIO/OSX Core Audio.

Playback

Selecting the Track on the CD to be Played

Play the CD on the DN-S1200.

CD-DA discs can be played.

※ MP3 files recorded on CD-R or other discs cannot be played.

❑ Loading the disc

- When the CD is inserted into the disc loading slot, the standby mode is set at the first track on the CD.
The **CUE** button lights when the standby mode is set.
- The Auto Cue function sets the standby mode to the position at which the sound starts.
The setting can be changed at "PRESET" – "(2) Auto Cue" (☞ page 27).

❑ Selecting the track

- Turn the **PARAMETERS** knob.
- Tracks can be selected in units of 10 by pressing the **PARAMETERS** knob while turning it.

SINGLE PLAY LOCK:

This function disables track selection during playback to prevent files from being selected or playback from stopping accidentally.

To cancel, press and hold in the **•TIME, -CONT./SINGLE** button.

Refer to the top panel's **⑫ •TIME, -CONT./SINGLE** button (☞ page 4).

Selecting the Track to be Played by USB

The DN-S1200 offers two types of playback modes, as described below.

- ※ To play tracks stored on a USB memory device, create a database.
Create the database using DB Create in the utility mode or using the included "DENON DJ Music Manager".

File Playback mode

MP3/WAV files are searched for and selected by artist name, album name, genre, year, BPM, etc., and played in units of files.

Playlist Playback mode

Playlists created and edited by the user are searched for and selected and the MP3/WAV files registered on that playlist are played. By using playlists, the DN-S1200 can be operated with the same feel as conventional CDs. Up to 1,000 playlists can be created per device. A maximum of 99 MP3/WAV files can be registered on each playlist.

The play mode switches between the file play mode and playlist play mode each time the **PLAYLIST** button is pressed. The play mode can also be switched by selecting "P-List Play" or "File Play" at the respective top menus.

The playlist play mode is set when the **PLAYLIST** button is pressed and held in.



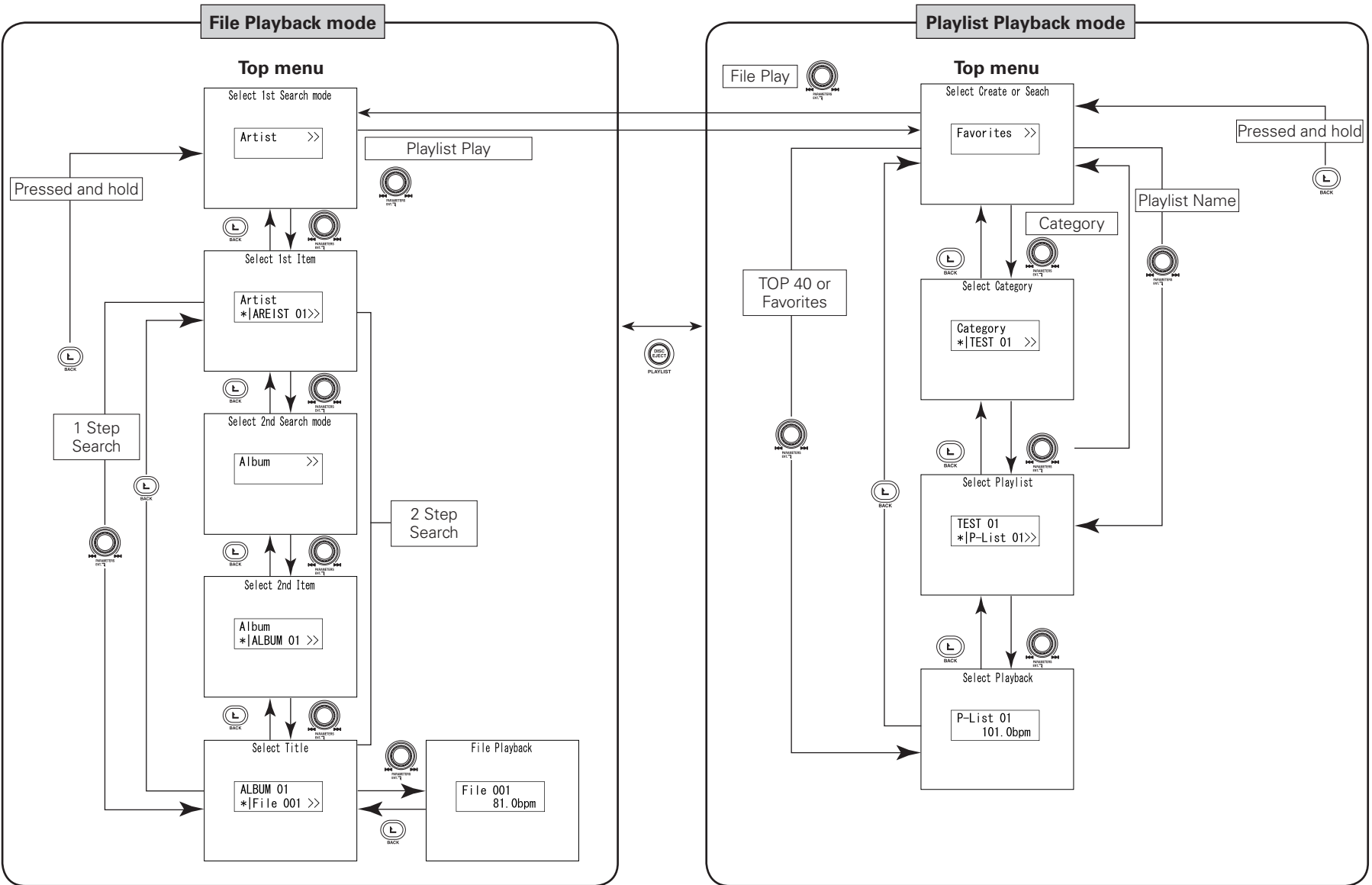

File Playback Mode

In this mode you search for MP3/WAV files on the devices and select them for playback.

There are two search modes.

- ① Searching for files using the information for one file.
- ② Searching for files using the combined information for two files.
This mode allows you to search for files with high precision.

Search modes

- ① 1Step Search (Factory Default)
- ② 2Step Search

Search mode	1st Search mode	2nd Search mode
Artist	Artist	Album
Album		Title
Title		Year
Genre		BPM
Year	Album	-
BPM	Title	-
File Name	Genre	Artist
Folder		Album
		Title
		Year
		BPM
	Year	Artist
		Album
		Title
		BPM
	BPM	Artist
		Album
		Title
		Genre
File Name		-
Folder		-

For search modes (Album, Title, File Name and Folder Name) for which no 2nd search mode is indicated, the second search mode cannot be selected. Searching is done in the same way as for 1-step searching. 1-step or 2-step searching can be selected at "PRESET" – "(15) Search Step" (page 27). You may also temporarily change the step searching by pressing the F12 key when a keyboard is connected, from the top menu.

Searching Procedure

The procedure for performing a file search from the top menu of the file playback mode is as described below.

To top menu

When in the playlist playback mode:

In the pause or standby mode, press the **PLAYLIST** button.



When in the file playback mode:

Either press the **BACK** button or press and hold it in for at least 1 second.



1 At the top menu of the file playback mode, turn the **PARAMETERS** knob or Scratch disc and select "Search mode".



2 Press either the **PARAMETERS** knob or the right side of the scratch disc to set.

※ A list of artist names is displayed.

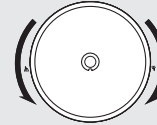

3 [When "Artist" is selected in step 1] Turn either the **PARAMETERS** knob or the Scratch disc to select the desired artist name.

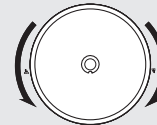

4 Press the **PARAMETERS** button to set.



5 Turn either the **PARAMETERS** knob or the Scratch disc to select the track you want to play.



6 Press the **PARAMETERS** button to set. The cue standby mode is set at the track selected in step 3.

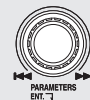

Searching by Folder Name

- 1 At the top menu of the file playback mode, turn either the **PARAMETERS** knob or Scratch disc and select “Folder”.



- 2 Press either the **PARAMETERS** knob or the right side of the scratch disc to set.

A list of file names is displayed.

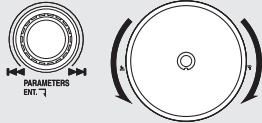

- 3 Turn either the **PARAMETERS** knob or the Scratch disc to select the desired folder name.

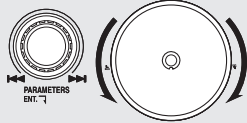

- 4 Press the **PARAMETERS** button to set.

A list of the tracks or the names of the folders within that folder is displayed.



- 5 Turn either the **PARAMETERS** knob or the Scratch disc to select the track you want to play.

※ When a folder name is selected, a list of the folders within that folder is displayed.
Press the **BACK** button to return to the display of the folder one folder up.

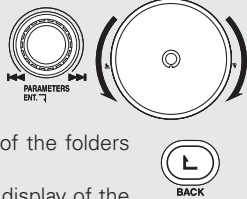

- 6 Press the **PARAMETERS** button to set.

The cue standby mode is set at the track selected in step 5.



Folder name searching is only possible for tracks/folders stored in the database.

Playlist Play Mode

This mode is for searching for and selecting playlists on a USB memory device and playing the MP3/WAV files registered on that list.

※ Use the included “DENON DJ Music Manager” to create playlists.

Playlist searching

The following describes the procedure for searching from the top menu in the playlist play mode.

To top menu

When in the file playback mode:

Press the **PLAYLIST** button while in the pause or standby mode.



- 1 At the top menu in the playlist play mode, turn either the **PARAMETERS** knob or the Scratch disc and select “Playlist Name” or “Category”.

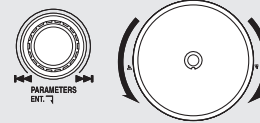

- 2 Press the **PARAMETERS** button to set.

The category or playlist names are displayed.

※ If “P-list Name” has been selected, proceed to step 3.



- 3 Turn either the **PARAMETERS** knob or the Scratch disc to select the category name.

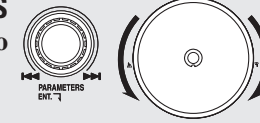

- 4 Press the **PARAMETERS** button to set.



- 5 Turn either the **PARAMETERS** knob or the Scratch disc to select the “Play List”.

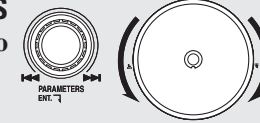

- 6 Press the **PARAMETERS** button to set.

A list of the tracks on the selected playlist is displayed.



- 7 Turn either the **PARAMETERS** knob or the Scratch disc to select the track you want to play.

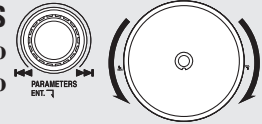

- 8 Press the **PARAMETERS** button to set.

The cue standby mode is set at the track selected in step 7.



About the “Top 40” and “Favorite” lists

These lists can be selected directly from the top menu in the playlist play mode. They allow you to select the desired track easily, without any troublesome searching operations.

Use the included “DENON DJ Music Manager” to edit them. A maximum of 40 tracks can be registered at “Top 40”; while up to 99 tracks can be registered at “Category”.

Text Search

In the USB play mode, tracks (files) and albums can be searched for by first letter or character string (but only in the file search and playlist search modes).

[Example]

To select a certain artist name, turn the **PARAMETERS** button while pressing it to display only the names of artists starting with a specific letter, number or symbol. (The names are displayed in alphabetical order.)

When the **PARAMETERS** button is turned while pressing it and "E" is selected, only artist names starting with "E" are displayed.

If a keyboard is connected, only artist names starting with the letters, numbers or symbols input from the keyboard are displayed. (Up to 8 characters can be input.)

Operation using the PARAMETERS knob

- 1** At the screen for selecting the name (artist, album, title, playlist, etc.), turn the **PARAMETERS** button while pressing it to select the desired character.



A list of only the names starting with the selected character is displayed.

*	All displayed
A ~ Z	Names starting with a letter from "A" ~ "Z"
#	Names starting with a letter number

※ When inputting characters to the keyboard input section as well, turn the **PARAMETERS** button while pressing it to display a list of the names starting with the selected character(s).

※ When the **PARAMETERS** button is turned while pressing it in the file search mode (artist, album, title, genre or file name) or the playlist search mode (category or p-list name), the character selection mode is set.

- 2** In the same way as with normal searching, turn either the **PARAMETERS** knob or the Scratch disc to select the name from the list.

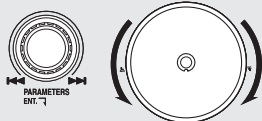

- 3** Press the **PARAMETERS** button to set.



Operating using the keyboard

- 1** At the screen for selecting the name (artist, album, title, playlist, etc.), use the keyboard to input the desired letters, numbers or symbols (maximum 8 characters).

A list of only the names including the selected character string is displayed.

※ For instructions on "About Character Input" (📖 page 23).

- 2** Turn either the **PARAMETERS** knob or the Scratch disc to select the name from the list.

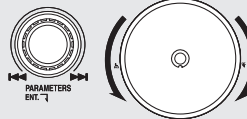

- 3** Press the **PARAMETERS** button to set.



When text searching has been performed using both the **PARAMETERS** knob and keyboard, the one operated last has priority.

Basic Operations

Operations

Playback and Pause

- 1** Press the ► || button to start playback.
The ► || button lights green during playback.



- 2** When the ► || button is pressed during playback, the pause mode is set at that position.

The ► || button flashes.

- ※ Press the ► || button again to resume playback from the point at which it was paused.



- 3** If the Scratch disc is held down during playback when the JOG MODE button is set to “SCRATCH”, playback is paused.

- ※ Playback resumes when the scratch disc is released.



Playback and CUE

- During playback, press the CUE button.

Playback stops and cues to the point where playback started (the cue point).

- ※ This function is called “Back Cue”.



- The Back Cue function can be used to always start playback from the same position.
- The **CUE** button lights red when the back cue mode is set.

The cue point is set or changed in the following cases:

- When playback is started from the pause mode
- When a new file is selected
- When the cue point is set in the manual search mode

Selecting tracks

Turn either the **PARAMETERS** knob or the Scratch disc.

- ※ Refer to “Selecting the Track on the CD to be Played (👉 page 9)” or “Selecting the Track to be Played by USB (👉 page 9)”.

Moving the cue point

If you want to start playback in the middle of a track, use the quick jump, fast search or manual search function to move the cue point.

- 1** Use the **FAST SEARCH** button to find the position from which you want to start playing.

Press and release the ◀▶▶▶ button immediately to jump 10 seconds forward or backward from the current position.

Press and hold in the ◀▶▶▶ button to fast-forward or fast-reverse.

- ※ The jumping time for the quick jump function can be selected at “PRESET” – “(6) Jump Time”. Refer to “PRESET” (👉 page 27).



- 2** Press the **JOG MODE** button and select “BEND/SEARCH”.



- 3** Turn the Scratch disc in the standby or pause mode to move the cue point 1 frame at a time while listening to the playback sound.



- 4** When the **CUE** button is pressed, the new cue point is set.

Press the **JOG MODE** button again to set the Scratch disc back to the scratch mode.



Changing the playing speed (pitch)

The playing speed (pitch) can be adjusted using the pitch slider. The key adjust function makes it possible to keep the key constant, regardless of the playing speed (pitch).

- 1** Press and immediately release the **PITCH/KEY** button.

The mode switches between pitch on and key adjust on each time the button is pressed.



- ※ The PITCH indicator lights when the pitch on mode is set, the “KEY ADJ.” indicator lights when the key adjust mode is on.

- 2** The playing speed is adjusted when the pitch slider is moved.

- 3** Press the **RANGE** button for at least 1 second.



- 4** Turn the **PARAMETERS** knob to select the pitch range.

The DN-S1200 offers six pitch ranges: 4%, 10%, 16%, 24%, 50% and 100%.



- 5** Press the **PARAMETERS** button to set.



NOTE

With MP3 files, the files cannot be played if the pitch is 24% or greater.

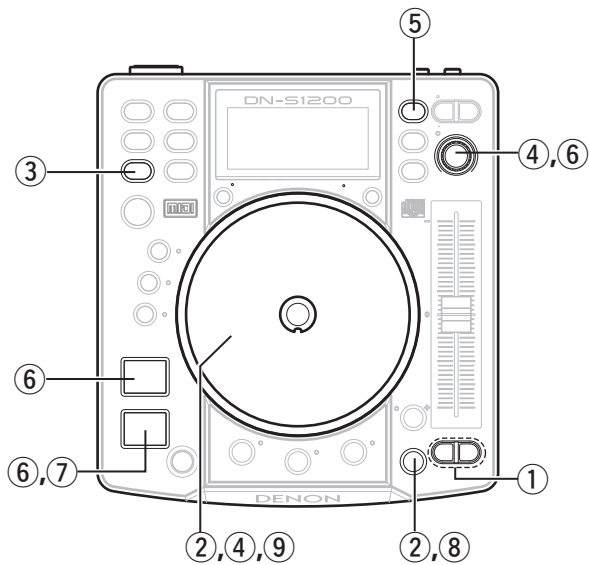

Changing the playing speed (pitch) temporarily

The pitch bend function can be used to change the playing speed temporarily. The DN-S1200 includes two pitch bend functions using the **PITCH BEND** buttons and the Scratch disc.

1 [PITCH BEND +/-]

① Press the **PITCH BEND +** button to increase the playing speed, the **PITCH BEND -** button to decrease the playing speed.

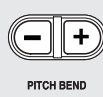

2 [PLATTER/SCRATCH]

② The scratch disc turns during playback when the **JOG MODE** button has been pressed to set the scratch disc mode to **“BEND/SEARCH”**.

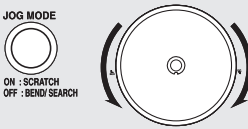

The playing speed changes.

Relay playback

Relay playback is possible when two DN-S1200s are connected by D-Link.

When “PRESET” – “(21) Relay” (page 27) is set to “ON”, the relay play mode is set.

- 1** In the single play mode, when the end of the track is reached, the standby mode is set at the next track and playback starts on the other DN-S1200.
- 2** In the continuous play mode, playback starts on the other DN-S1200 once the last track is played.
- 3** When the relay play mode on two DN-S1200s is used, playback is performed alternately on the two DN-S1200s.
 ※ When “PRESET” – “(21) Relay” (page 27) is set to “OFF”, the relay play mode is canceled.

Power on playback

When “PRESET” – “(20) Power on Play” (page 27) is selected and the power is turned on with a disc loaded, playback starts from the first track on the disc.

NOTE

If no disc is loaded, playback will not start when the power is turned on, even if “Power on Play” is set to “ON”.

Next Track Function (CD/USB)

This function allows you to select the next track during playback, without interrupting the currently playing track. The cross fader can be used for a smooth transition to the next track.

1 Turning the next track mode on.

- ③ During playback, press the **NEXT TRACK** button.



The **CUE** button flashes when the next track mode is on.



- ※ During seamless looping, the A/B TRIM mode is set.
- ※ When the **NEXT TRACK** button is pressed again while the next track mode is on, the next track mode is turned off.
- ※ Only files from the same source can be selected in the next track mode.

2 Selecting the track.

- ④ Turn either the **PARAMETERS** knob or the **Scratch disc** to select the track you want to play next.



3 Selecting tracks with memo data.

- ⑤ When the **MEMO** button is pressed at this time, the cue point of the memo data stored as the next track is selected.



- ※ When another track is selected with the **PARAMETERS** knob or the **MEMO** button is pressed again, the stored memo data's cue point is canceled.



5 Starting file search.

- ⑥ When the **PARAMETERS** knob or **CUE** button is pressed after the file is selected, the selected track is searched for in the play mode.



Once searching is completed and the standby mode is set, the **CUE** button lights and the **▶ ||** button flashes.



- ※ The time display after the **CUE** button is pressed indicates the remaining playable time for the currently playing track.

6 Starting next track playback.

- ⑦ When the **▶ ||** button is pressed, playback of that track stops and playback of the next track starts.



- ※ The currently playing track can be faded out when the next track is played.
- ※ The fade-out time is 5 sec. max. This time can be set at "PRESET" – "(4) NEXT Tr Cfade" (page 27).

- ⑦ Even if the next track is ready to play, if the **▶ ||** button is not pressed, when in the continuous play mode, playback of the next track begins when playback of the current track has ended.



The operation is the same in the single play mode.

NOTE

- The remaining playable time for the currently playing track is a maximum of 10 seconds after the next track is searched for.
- You can push **▶ ||** button at any time during these last 10 sec to start the Next track.

Scratch

1 Selecting the scratch mode.

- ⑧ Press the **JOG MODE** button and select "Scratch".



The **JOG MODE** button/flashes orange.

- ※ Scratch play can be performed immediately when the **JOG MODE** button is lit.
- ※ When the **JOG MODE** button is flashing or off, it is not possible to start scratch play immediately because for example no disc is loaded or the parameter input mode is set.

2 Starting scratch play.

- ⑨ Press and turn the **Scratch disc**.

Scratch play starts.



3 Stopping scratch play.

- Release the **Scratch disc**.

Scratch play stops and the play or pause mode is set.



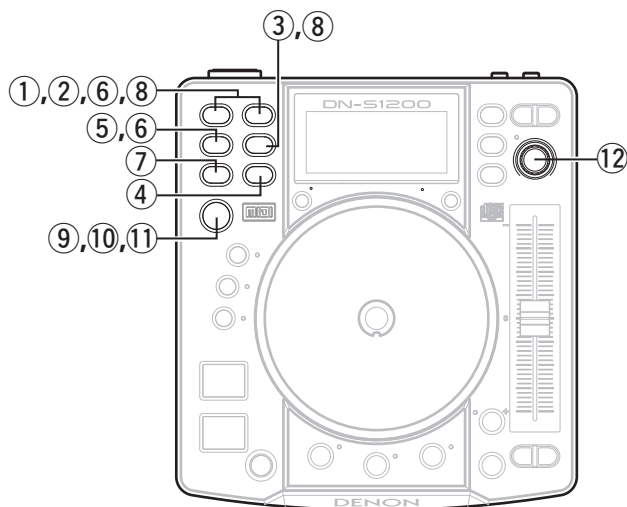

Seamless Loop/Hot Start/Stutter

Seamless Loop Playback/Hot Start Playback/Stutter Playback

1 Setting the A point.

① Press the **A1** or **A2** buttons.

The A point is set at the point at which the button is pressed.

- ※ The **A1** or **A2** buttons can be used independently for different hot start settings.
- ※ When the A point is set, the “A” and “c” indicators light and the hot start mode is set.
- ※ The BPM is set automatically and independently for the different hot starts settings.



2 Starting hot start play.

② Press the **A1** or **A2** buttons.

Once the A point is set, press the A1 or A2 button to set hot start play.



3 Seamless looping starts.

③ After setting the A point or after starting hot start play, press the **B** button.

The B point is set and seamless loop play is set from the A point.

- ※ The B point is set with respect to the A point that was set before pressing the **B** button.

During seamless looping or after exiting the seamless loop, press the **B button.**

The B point moves to the point at which the **B** button was pressed.

- ※ When the B point is set, the “B” and “▷” indicators light.



4 Seamless loop play.

- ※ When the B point is detected during A1-B loop playback, seamless loop playback returns to the A1 point.
- ※ When the B point is detected during A2-B loop playback, seamless loop playback returns to the A2 point. The A1-B loop's B point is ignored during A2-B looping.

5 Exiting a loop/Returning to a loop.

④ Press the **EXIT/RELOOP** button.

Press the **EXIT/RELOOP** button to exit or return to a seamless loop.

EXIT:

It is possible to exit a seamless loop during seamless loop playback. With the DN-S1200, playback continues from B point once the seamless loop is exited.

RELOOP:

When the **EXIT/RELOOP** button is pressed after exiting the seamless loop, seamless looping starts from the A point.



6 Stutter play.

The **A1** or **A2** buttons can be used for stutter playback.

⑤ Press the **FLIP** button.

The “c” and “▷” indicators turn off and stutter play is possible.

- ※ The mode switches between hot start/seamless loop and stutter play each time the **FLIP** button is pressed.



7 Clearing the A1 and A2 points.

⑥ Quickly push and hold the **FLIP** button down and then press the **A1** or **A2** buttons with your other finger.

The A1-B or A2-B loop is cleared.

- ※ All the A and B points can be cleared by pressing the **FLIP** button for over 1 second.

It is possible to clear only the last B point played by pressing the **B** button while pressing the **FLIP** button.



The A1 or A2 point is cleared by force if the device is changed or the playlist is changed while in the playlist play mode.

A/B Trim

The positions of the seamless loop A and B points can be fine-adjusted with the Scratch disc.

The points can be fine-adjusted while listening to the loop play sound.

1 ⑦ During seamless looping, press the A/B TRIM button to turn on the adjustment mode.

※ During playback in modes other than looping, the next file mode is set when the **A/B TRIM** button is pressed.



2 ⑧ Press the A1 or A2 buttons to select the A point.

※ Adjustment is possible for the currently playing loop.



※ Press the **B** button to select the B point.



3 Turn the Scratch disc to adjust the A or B point.

The position can be adjusted in units of frames.

A Point:

±30 frames from the A point. If there is a B point, however, adjustment is only possible up to 5 frames before the B point.

B Point:

Adjustment is possible from 5 frames after the A point through the end of the track.

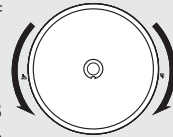

4 Press the A1 button to set the A point.

When set, the A/B TRIM mode is exited automatically.



Auto BPM Counter

The BPM for the currently playing track or the track at which the cue standby mode is set is measured automatically and displayed.

- When the auto BPM counter is off, press the **TAP** button for over 1 second to turn the auto BPM counter on.
- When the auto BPM counter is off, it turns on when the track changes.

NOTE

It may not be possible to automatically measure the BPM accurately for some tracks.

In this case, perform the “TAPPING” or “MANUAL INPUT” procedure.

1 BPM LOCK

The data measured with the auto BPM function is locked.

- ⑨ When the auto BPM counter is on, press the **TAP** button and release it immediately.



“BPM LOCK” is displayed for about 1 second.

2 TAPPING

The BPM is measured according to the interval between repeated pressings of the **TAP** button.



When the **TAP** button is pressed, the auto BPM counter turns off.

The “Manual in” is displayed.

- ⑩ Press the **TAP** button repeatedly 5 ~ 10 times to the beat of the music.

3 MANUAL INPUT

- ⑪ Press and hold the **TAP** button for over 2 seconds.



The BPM can now be input manually.

- ⑫ Turn the **PARAMETERS** knob and input the BPM value.



※ Turn the **PARAMETERS** knob while pressing it to input values below the decimal point.

※ When the **TAP** button is pressed again, the value you have input is set and the BPM value is locked.

NOTE

If the MP3 or WAV file includes BPM information in the memo data, this value is displayed as the initial value. The AUTO/TAP/MANUAL value can be ignored as this information is more detailed.

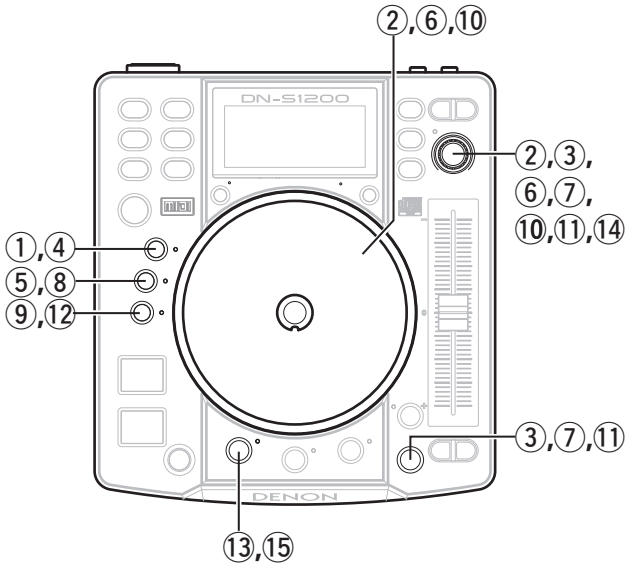

Effector

One of the three types can be selected.

Echo/loop Parameter Setting

1 Turning echo/loop on.
1 Press the **ECHO/LOOP** button.
 The **PARAMETERS** knob lights and the parameters setting screen is displayed.

※ When echo/loop indicator is solid (not blinking), press the **ECHO/LOOP** button to set the parameter selection mode again.

2 Setting the echo/loop parameters.
2 Turn either the **PARAMETERS** knob or the Scratch disc to set the echo/loop parameters.
 The **PARAMETERS** knob flashes.
 ※ The echo feedback level can be set with the scratch disc, the echo delay time with the **PARAMETERS** knob.

3 Performing echo/loop playback.
 When the feedback level is set to the maximum, echo/loop playback begins with the specified delay time.
 ※ During echo/loop playback, it is possible to search for tracks and switch between the file play mode and playlist play mode.

Loop fade-out:
 In the parameter selection mode, when the back cue or next track mode is turned on during echo/loop playback, the parameter selection mode is turned off.
 When a new track is selected and playback is started, echo/loop playback fades out and stops. This makes for a smooth transition between echo/loop playback and normal playback.

4 **3** Press the **PARAMETERS** knob or the **JOG MODE** button to turn off the parameters setting screen.

5 **4** Press the **ECHO/LOOP** button while the flanger parameters setting screen is displayed.
 Turning echo/loop off.

Flanger Parameter Setting

1 **5** Press the **FLANGER** button.
 When the **FLANGER** button is pressed, the **FLANGER** button lights and the parameters setting screen is displayed.
 ※ When the flanger indicator is solid (not blinking), press the **FLANGER** button to set the flanger parameter selection mode again.

2 **6** Turn either the **PARAMETERS** knob or the Scratch disc to set the flanger parameters.
 The **FLANGER** button and **PARAMETERS** button flash while the parameters are being set.
 ※ The **FLANGER** Depth can be set with the Scratch disc, while the **FLANGER** Delay Time can be set with the **PARAMETERS** knob.

3 **7** Press the **PARAMETERS** knob or the **JOG MODE** button to turn off the parameters setting screen.

4 **8** Press the **FLANGER** button while the flanger parameters setting screen is displayed.
 Turning the flanger off.

Filter Parameter Setting

1 ⑨ Press the **FILTER** button.

When the **FILTER** button is pressed, the FILTER button lights and the parameters setting screen is displayed.



※ When filter indicator is solid (not blinking), press the **FILTER** button to set the filter parameter selection mode again.

2 ⑩ Use the **FILTER** button or scratch disc to set the filter parameters.

The **FILTER** button and **PARAMETERS** button flash while the parameters are being set.

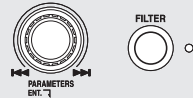

※ The Feedback Level can be set with the Scratch disc, while the Echo Delay Time can be set with the **PARAMETERS** knob.

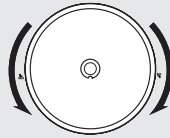

3 ⑪ Press the **PARAMETERS** knob or the **JOG MODE** button to turn off the parameters setting screen.

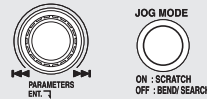

4 ⑫ Press the **FILTER** button while the filter settings screen is displayed.

Turning the filter off.



Platter Effects

Brake Operating Time Setting

This simulates a turntable gradually slowing and stopping playback.

1 ⑬ Press the **BRAKE** button.

When the **BRAKE** button is pressed, the brake mode is turned on, and the **BRAKE** button and **PARAMETERS** button flash for about 3 seconds to indicate the brake operating time.



2 ⑭ Turn the **PARAMETERS** knob to set the brake operating time.

The operating time is set and the operating time setting mode is canceled.



※ If no operation is performed for about 3 seconds after the first time the **BRAKE** button is pressed or the adjustment is performed with the **PARAMETERS** knob, selection of the brake operating time is canceled automatically.



Operating the Brake

1 During playback, press the **▶ ||** button.



2 To cancel brake operation, press the **▶ ||** button again during brake operation.

Brake operation is canceled.



□ Turning the brake mode off

⑮ Press the **BRAKE** button while the brake is operating.

The brake mode turns off.



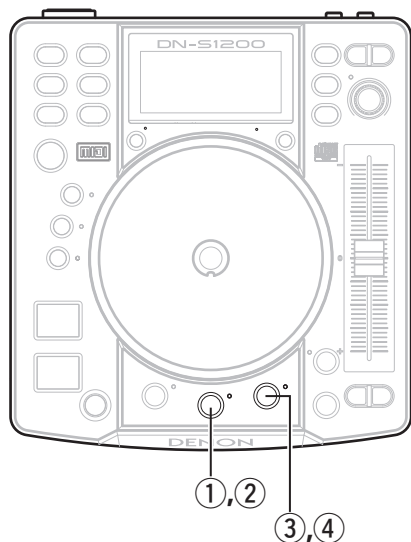

Dump Play

This function allows effect playback combining reverse playback with normal forward playback.

- ① **During playback, press the DUMP button.**

Dump playback starts.



❑ Dump effect

During playback, press the DUMP button.

- ※ The mode switches between dump playback and normal playback each time the **DUMP** button is pressed.
- ※ Dump playback turns off if the hot start or stutter play operation is performed.



❑ Turning dump playback off

- ② **Press the DUMP button during dump playback.**

Dump playback turns off.



NOTE

DUMP time effect is 4 sec. max.

Reverse Play

- ③ **During playback, press the REVERSE button.**

The reverse function turns on and reverse play starts.



❑ Reverse effect

During playback, press the REVERSE button.

- ※ The mode switches between reverse playback and normal playback each time the **REVERSE** button is pressed.
- ※ Dump playback turns off if the hot start or stutter play operation is performed.



❑ Turning reverse playback off

- ④ **Press the REVERSE button while the reverse function is on.**

Reverse playback turns off.



NOTE

If Reverse playback reaches the beginning of the tracks during Single mode, the Cue mode will be set and playback stops.

Memo Function (Custom Setting Memory)

The setting information can be stored in the file. The stored information can be called out of the memory at later time, making it easy to prepare for your mixing.

About Memo

For the memo function, the data that can be stored in the memo differs according to the playback mode.

① In the CD play mode

Up to 5000 memos can be stored, one memo per track. For a disc with 22 tracks, for example, 22 memos can be set.

NOTE

The track memo function's memory system handles 1000 memos as one package (1000 memo – 5 packages). Since this memo system's memory is deleted in units of packages, when one memo is deleted, the memo number remains and the memory area does not increase. Thus, the actual number of memos that can be stored is reduced. "Memo Full!" is displayed when 5000 memos are stored. In this case, the memory for one package worth of memos (1000 memos) must be deleted, starting from the oldest memos.

※ When a disc for which memo data is set is loaded, the "MEMO" indicator flashes. The indicator lights when a track for which there is memo data is selected.

The data stored in the memory is as follows:

- Cue point
- A1 and B1 points, A2 and B2 points
- Playing pitch, pitch on/off, Key Adjust on/off setting
- BPM data (Cue, A1 and A2 points)

• The A1, A2, B1 and B2 points may be on different track, as long as they are within the disc.

② For the file playback mode

• The memo data is stored in the MP3/WAV file itself, so once memo data is stored in the file, it can be called out and used when playing the file on a different DN-S1200.

• The MEMO mode is not set in the following cases:

- When the MEMO operation is being executed on the other deck.
- When the database is being loaded.
- When the same file is selected on both decks.

• If the memo operation is possible for the deck on the side for which memo operation is set, the memo operation can be executed even when the deck on the other side is playing.

• If the same track is selected for the deck on the other side, however, or if you attempt to switch to the same track, the memo operation cannot be executed.

• Furthermore, if while the memo operation is being executed you attempt to search and play the track for which the memo operation is being performed on the other deck, searching is canceled and playback is stopped.

The data stored in the memory is as follows:

- Cue point
- A1 and B1 points, A2 and B2 points
- Playing pitch, pitch on/off, Key Adjust on/off setting
- BPM data (Cue, A1 and A2 points)

- The point data is limited to data within the same file when using a USB memory device.
- The "MEMO" indicator on the display lights up when a file for which data is storing within a file is selected.
- The memo function cannot be used with VBR files.
- ③ For the playlist playback mode
 - The memo data is stored in the playlist file itself, so when transporting playlist files in which the memo data has been stored and playing them on a different DN-S1200, that data can be called out and used.
 - Memo data can be stored a total of times equal to the number of files registered in the playlist.
 - For example, if 74 files are registered in a playlist, 74 bits of memo data can be stored in that playlist.

The data stored in the memory is as follows:

- Cue point
- A1 and B1 points, A2 and B2 points
- Playing pitch, pitch on/off, Key Adjust on/off setting
- BPM data (Cue, A1 and A2 points)

- The A1, A2, B1 and B2 points may be on different files, as long as they are within the playlist.
- The memo data can be used in the same way as with conventional CDs.
- The "MEMO" indicator on the display lights up when a file for which data is storing within a file is selected.
- The memo function cannot be used with VBR files.

Memo Mode Select

- ① Push the **MEMO** button during Cue mode to enter MEMO mode.
- ② Turn the **PARAMETERS** knob to select the various MEMO modes from as follows.
Memo Set (default), Memo Call, Memo Clr
Depending on conditions, some modes cannot be selected.
- ③ Push the **MEMO** button again to exit MEMO mode.

(1) Storing data in the memory [Memo Set]

- After making the settings to be storing within a file, then push **CUE** button.
- When the "MEMO" indicator in the display is off during CUE mode, push **MEMO** button to enable Memo set function.
- If the "MEMO" indicator lights up, it is necessary to clear existing Memo before storing a new Memo.
- At last push **PARAMETERS** button to save. You can see "Complete!" message and the "MEMO" indicator lights up.
- When the Memo Set function cannot be used, check the remaining space on the device.
It may not be possible to store data in the memory if there is too little space left.
It may not be possible to store memo data when the remaining memory space is low.
- When the memory is full, "Memo Full" or "Delete 1000?" appears. If this message is displayed, the memory for 1000 memos, starting from the oldest memo, must be deleted to free up new space.
To make space, press the **PARAMETERS** button while "Delete 1000" is displayed.
When the **PARAMETERS** button is pressed while the confirmation message "Delete OK?" is displayed, the memory for 1000 memos is deleted.

(2) MEMO CALL [Memo Call]

- When a file for which a memo has been stored is called out, the “MEMO” indicator flashes for about 5 seconds or less.
- To call out the Memo data, select the file that you made a “MEMO”. Then the “MEMO” indicator lights up.
- Push the **MEMO** button to enable Memo call function.
- When the **PARAMETERS** button is pushed in the Memo call mode, all the data stored in the memory is loaded. DN-S1200 goes to standby mode at the called Cue point.
- When the playing pitch is loaded from the Memo with “PITCH” indicator flashes, playing Pitch is locked until Pitch Slider comes same Pitch. While playing Pitch is locked, “PITCH” indicator keeps flashing.

NOTE

MEMO CALL of MP3 files may not be completed according to the file condition.

(3) MEMO CLEAR [Memo Clr]

- To clear one Memo data, select the file that you stored a MEMO. Then the “MEMO” indicator lights up.
- Push the **MEMO** button to enable Memo clear function.
- Turn the **PARAMETERS** knob until “MEMO CLEAR” is displayed.
- When the **PARAMETERS** knob is pushed in MEMO CLEAR mode, the Memo data is cleared and the “MEMO” indicator on the display turns off.
- All the CD memos can be cleared at once using the utility mode (“ALL Clear” in the utility’s memo data mode (page 24)).

(4) Sharing memo data

When two DN-S1200s are connected by D-Link, the memo data can be shared. The memo data sharing function allows you to store up to 10,000 memos.

NOTE

When there is memo data for the same track on the two DN-S1200s, the memo data on the DN-S1200 on which the memo was called out is used.

It is not possible to delete the memo data on the other DN-S1200 connected by D-Link. Perform the operation on the DN-S1200 on which the data is stored.

When the memo data on the other DN-S1200 connected by D-Link can be referenced, it is not possible to store the data even if there is no memo data on the DN-S1200 being operated. To store the data, either cancel the D-Link connection or first delete the memo data in question from the DN-S1200 connected by D-Link.

About Character Input

With the DN-S1200, when inputting characters for playlist names, etc., the characters can be input using from a keyboard.

Characters can be input efficiently in the same way as when operating a computer’s keyboard.

Character Input Using the Keyboard

1 Input the character.

※ When the characters are typed on the keyboard, they are added at the end of the character input section.

2 Clearing characters.

※ Delete characters in the character input section by operating the keyboard’s “BACK SPACE” keys.

3 Enter the string of characters you have input.

※ When the keyboard’s “ENTER” key is operated, the string of characters in the character input section is entered and move to the next screen.

NOTE

The characters usable on the DN-S1200 are as shown on the diagram below. Note that usable characters differ according to the character input target.

	ID3 Tag (ASCII/Unicode (UTF-8/UTF-16))	File Name/ Playlist Name	ID3 Tag (Genre)
Alphabet	A B C D E F G H I J K L M N O P Q R S T U V W X Y Z a b c d e f g h i j k l m n o p q r s t u v w x y z	A B C D E F G H I J K L M N O P Q R S T U V W X Y Z a b c d e f g h i j k l m n o p q r s t u v w x y z	A B C D E F G H I J K L M N O P Q R S T U V W X Y Z a b c d e f g h i j k l m n o p q r s t u v w x y z
Numbers	0 1 2 3 4 5 6 7 8 9	0 1 2 3 4 5 6 7 8 9	0 1 2 3 4 5 6 7 8 9
Symbols	Space ! " # \$ % & ' () * + , - . / : ; < = > ? @ [\] ^ _ ` { } ~	Space ! # \$ % & ' () + , - . ; = @ [^ _ ` { } ~	Space & () + ...
ISO 8959-1	¡ ¢ £ ¤ ¥ ¦ § ¨ ¯ ° ± ² ³ µ ¶ · ¸ ¹ º » ¼ ½ ¾ ¿ À Á Â Ã Ä Å Æ Ç È É Ê Ë Ì Í Î Ï Ñ Ò Ó Ô Õ Ö × Ù Ú Û Ü Ý Þ ß à á â ã ä å æ ç è é ê ë ì í î ï ð ñ ó ô õ ö ÷ ø ù ú û ü ý þ	¡ ¢ £ ¤ ¥ ¦ § ¨ ¯ ° ± ² ³ µ ¶ · ¸ ¹ º » ¼ ½ ¾ ¿ À Á Â Ã Ä Å Æ Ç È É Ê Ë Ì Í Î Ï Ñ Ò Ó Ô Õ Ö × Ù Ú Û Ü Ý Þ ß à á â ã ä å æ ç è é ê ë ì í î ï ð ñ ó ô õ ö ÷ ø ù ú û ü ý þ	¡ ¢ £ ¤ ¥ ¦ § ¨ ¯ ° ± ² ³ µ ¶ · ¸ ¹ º » ¼ ½ ¾ ¿ À Á Â Ã Ä Å Æ Ç È É Ê Ë Ì Í Î Ï Ñ Ò Ó Ô Õ Ö × Ù Ú Û Ü Ý Þ ß à á â ã ä å æ ç è é ê ë ì í î ï ð ñ ó ô õ ö ÷ ø ù ú û ü ý þ

NOTE

You can perform any Search functions using these Latin-1 characters. Be sure to make the region setting at “Region” in the presetsings.

Utility

The DN-S1200 offers the utilities described below.

DB Create:

A database is created on the external USB memory device connected to the DN-S1200. This makes it possible to search for MP3/WAV files on the DN-S1200.

Preset Data:

Saves the presettings along with data on a device and reads out the presettings. Selects the Power On Play playlist.

Memo Data:

This function allows you to store CD memo data onto and import the data from a device.

It can also be used to delete the internal CD memo data.

Memo Data:

This utility can be used to format the external USB memory device connected to the DN-S1200. It can also be used to restore the presettings and memo data to the factory defaults.

Utilitymode

1 When in the standby or pause mode or when no file is selected, press and hold in the **UTILITY** button for at least 1 second to enter the Utility mode.



2 Use the **PARAMETERS** knob to select the utility item.

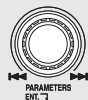

3 Press the **UTILITY** button to turn the Utility mode off.



DB Create

A database is created on the external USB memory device connected to the DN-S1200. This makes it possible to search for MP3/WAV files on the DN-S1200.

NOTE

When a database has already been created on the external USB memory device, the database is reset. Playlists that have been created are also deleted.

Setting the Database Edit Mode

1 At the top menu in the Utility mode, turn the **PARAMETERS** knob or Scratch disc select “**DB Create**”.

※ This cannot be selected if no external USB memory device is connected.

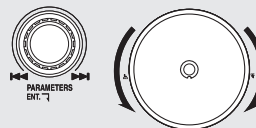

2 Press the **PARAMETERS** button again to enter. The “DB Create” list is displayed.



Creating Databases

1 At the top menu in the DB Create, turn the **PARAMETERS** knob or Scratch disc select “**Full Create**”.

The database creation mode is set.



2 Confirm whether or not you want to create the database.

When “OK” is selected:

The database is created on the external USB memory device. The progress is displayed.

When “Cancel” is selected:

The screen in step 1 reappears. The database is not created on the external USB memory device. The screen returns to as it was in step 1.

Creating Temporary Databases

Use this procedure to create a database searchable by file name only.

This database can be created faster than a full database.

※ Searching using ID3 Tag data is not possible.

1 At the top menu in the DB Create, turn the **PARAMETERS** knob or Scratch disc select “**Temporary**”.

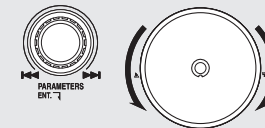

2 Confirm whether or not you want to create the database.

When “OK” is selected:

The temporary database is created on the external USB memory device. The progress is displayed.

When “Cancel” is selected:

The temporary database is not created on the external USB memory device. The screen returns to as it was in step 1.

NOTE

File name searching is not possible with iPods, so the temporary database cannot be used.

Preset Data

Use this procedure to save the presettings along with the data on a device and to read out the presettings.

Preset Data mode

- At the top menu in the Utility mode, turn the **PARAMETERS** knob or Scratch disc and select “Preset Data”.

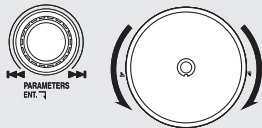

- Press the **PARAMETERS** button again to enter. The “Preset Data” list is displayed.



Preset Import (Importing Preset Data)

- At the top menu in the Preset Data, turn the **PARAMETERS** knob or Scratch disc select “Import”. A message for confirming that you want to overwrite the internal data is displayed.

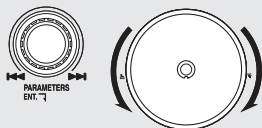

※ The unit is set to the import mode.

- Select the setting item.

When “OK” is selected:

The import operation is performed. When it is completed, the screen in step 1 reappears.

When “Cancel” is selected:

The screen in step 1 reappears.

Preset Export

- At the top menu in the Preset Data, turn the **PARAMETERS** knob or Scratch disc select “Export”.

When there is no preset data on the external USB memory device:

The export operation is performed.

When there is preset data on the external USB memory device:

Step 2.

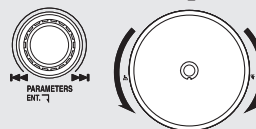

- Select the setting item.

When “OK” is selected:

The export operation is performed.

The progress bar is displayed so you can check the progress. When it is completed, the screen in step 1 reappears.

When “Cancel” is selected:

The screen in step 1 reappears.

Memo Data

This function allows you to store CD memo data onto and import the data from a device. It can also be used to delete the internal CD memo data.

Memo Data mode

- At the top menu in the Utility mode, turn the **PARAMETERS** knob or Scratch disc and select “MEMO Data”.

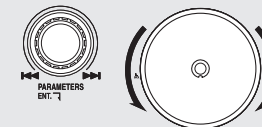

- Press the **PARAMETERS** button again to enter. The “MEMO Data” list is displayed.



Memo Import (Importing Memo Data)

- While the top menu in the memo mode is displayed, turn either the **PARAMETERS** knob or the Scratch disc to select “MEMO Import”.

A message for confirming that you want to overwrite the internal data is displayed.

※ The DN-S1200 is set to the memo import mode.

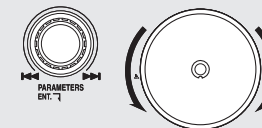

- Select the setting item.

When “OK” is selected:

The import operation is performed.

When it is completed, the screen in step 1 reappears.

When “Cancel” is selected:

The screen in step 1 reappears.

Memo Export (Exporting Memo Data)

- 1 At the top menu in the Memo, turn the **PARAMETERS** knob or Scratch disc select “MEMO Export”.

When there is no preset data on the external USB memory device:

The export operation is performed.

When there is preset data on the external USB memory device:

Step 2.

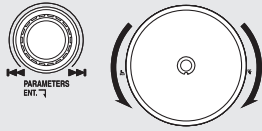

- 2 Select the setting item.

When “OK” is selected:

The export operation is performed.

The progress bar is displayed so you can check the progress. When it is completed, the screen in step 1 reappears.

When “Cancel” is selected:

The screen in step 1 reappears.

Initialize

This utility can be used to format the external USB memory device connected to the DN-S1200. It can also be used to restore the presettings and memo data to the factory defaults.

Initialize Mode

- 1 At the top menu in the Utility mode, turn the **PARAMETERS** knob or Scratch disc and select “Initialize”.

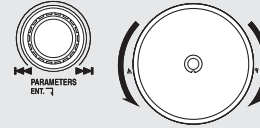

- 2 Press the **PARAMETERS** button again to enter. The “Initialize” list is displayed.



S1200 Init.

- 1 At the top menu in the Initialization, turn the **PARAMETERS** knob or Scratch disc and select “S1200 Init.”.

※ The unit is set to the factory default mode.

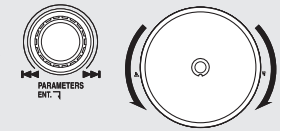

- 2 Press the **PARAMETERS** button again to enter. A confirmation message appears on the screen.

When “OK” is selected:

Factory Default.

When “Cancel” is selected:

The screen in step 1 reappears.



NOTE

- When this operation is performed, all the data on the DN-S1200 is deleted.
- Be very careful before performing this operation.

USB Format (Formatting External USB Memory Devices)

- 1 At the top menu in the Initialization, turn the **PARAMETERS** knob or Scratch disc and select “USB Format”.

※ The DN-S1200 is set to the Format mode.

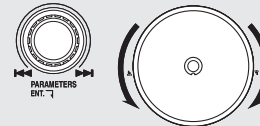

- 2 Press the **PARAMETERS** button again to enter. A confirmation message appears on the screen.

When “OK” is selected:

Formatting starts.

When formatting starts, a progress bar is displayed, allowing you to follow the progress.

When “Cancel” is selected:

The screen in step 1 reappears.



NOTE

- When this operation is performed, all the data on the DN-S1200 is deleted.
- Items and data that can be preset.

Preset

Preset Mode

- 1** When both Decks are in the standby or pause mode, press and hold in the **PRESET** button for at least 1 second to enter the preset mode.



- 2** Use the **PARAMETERS** knob to select the preset item.



- 3** Select the item and press the **PARAMETERS** knob to set the preset item to be changed.



- 4** Next, turn the **PARAMETERS** knob. The preset data is selected.



- 5** Select the data and press the **PARAMETERS** knob to set the preset data to be changed.



- 6** After selecting the data, press the **PARAMETERS** knob and change the preset data.

※ To set multiple presettings, repeat steps 2 ~ 5.

- 7** The preset mode is turned off when the **PRESET**, **CUE** or **PLAY/PAUSE** button is pressed.



Items and Data that can be Preset

The "*" mark next to the data indicates the default value.

- (1) Cue Mode:DENON* / OTHER
DENON*: When the playback is started during the Play Pause mode, the Cue point is set.
Other: When the **CUE** button is pushed during the Play Pause mode, the Cue point is set.
- (2) Auto Cue:Auto Cue level OFF / -60 dB / -54 dB* / -48 dB
- (3) Cross fader Level:OFF / -60 dB / -54 dB* / -48 dB
- (4) Next File Tr:OFF / 1 sec / 2 sec / 3 sec* / 4 sec / 5 sec
Select the time for fading out the currently playing file when playback of a new track is started with the next Tr function.
- (5) 3/4EFFECT:OFF* / ON
You can use 3/4 beat effects when you select the Echo and Flanger parameter for the effector.
- (6) Jump Time:10 sec* / 20 sec / 30 sec / 1 min
Select the jump time of Quick Jump.
- (7) Pitch Range:±4 % / ±10 %* / ±16 % / ±24 %
Select the playing pitch range when the power is turned on.
- (8) EOM (End Of Message)Time:OFF / 10 sec* / 15 sec / 20 sec / 30 sec / 60 sec / 90 sec
File end warning message alert time. When the remaining time in the currently playing track reaches the specified time, the play position indicator flashes to notify you that the end of the track is approaching.
- (9) Fader Mode (FADER START MODE):2LP/Cue* / 2LP/Pas / 1LP/Cue / 1LP/Pas
Select 2-line type (Play / Cue) or 2 line type (Play / Pause) or 1 line type (Play / Cue) or 1 line type (Play / Pause).
- (10) Pitch:Pitch ON* / Key AdjON (KEY ADJUST ON) / Pitch OFF
Select the pitch mode when the power is turned on.
- (11) Play Mode:Single / Cont. / Play Lock*
Select the play mode when the power is turned on.
- (12) Time Mode:Elapsed* / Remain
Select the time mode when the power is turned on.
- (13) TT Tricks:ON / OFF*
Select the JOG operation when you scratch in the BRAKE mode.
- (14) Audio Curve:ON* / OFF
Select "OFF" for Serato Scratch Live or other "control signal" programs.
For more information about Serato™, products please visit their website "www.scratchlive.net".
- (15) Search Step:1Step* / 2Step
Select the number of steps for file searching.
- (16) Playback Mode:File* / Playlist
Select the USB play mode selected when the power is turned on.
- (17) File Search:Artist* / Album / Title / Genre / Year / BPM / File Name / Folder
Select the file search mode setting for the USB play mode when the power is turned on.
The preset data differs according to the playback mode. When the playback mode is set to "File".
- (18) Playlist Search:Create* / Favorite / Top40 / Playlist Name / Category
Select the playlist search mode setting for the USB play mode when the power is turned on.
The preset data differs according to the playback mode. When the playback mode is set to "Playlist".
- (19) BPM Search Range:±0 / ±1 / ±3* / ±5 / ±10
Set the setting range for searching using the BPM search function.
- (20) Power On Play:ON / OFF*
When this is set to "ON" and the power is turned on while a CD is loaded, playback of that CD starts.
- (21) Relay:ON / OFF*
Set "Relay Mode" to "ON / OFF".
- (22) Region:USA* / Other
Select the same region as the region set on the computer on which "DENON Music Manager" is installed.
- (23) KB Type:ENGLISH (US)* / ENGLISH (UK) / DEUTSCH / FRANCAIS / ITALIANO / ESPANOL / NEOERLANOS / SVENSKA / CHINESE / JAPANESE
Select the language type of the keyboard being used.
- (24) MIDI CH Set:1* to 6
Select the MIDI channel.
- (25) JOG Trns Int:1ms to 20ms (The default is 3 ms.)
Select the MIDI channel.
- (26) Unit No Set:1 to 14 / ALL*
Select the device's unit number.
[Example]
If two units of DN-S1200s are connected to the computer, set one unit to No.1, the other to No.2.

(27) Version No: The DN-S1200's software version is displayed. (SYSTEM / DSP)

(28) Touch Int.: The Adjust the Scratch disc.

- 1) Press the **PARAMETERS** knob and select "Touch Int."
"Cancel" flashes on the character display.
- 2) Turn the **PARAMETERS** knob to display "OK".
- 3) Press the **PARAMETERS** button.
"Touch Initial!" is displayed once initialization is completed.
- 4) Once clearing is completed, "Completed!" is displayed.

(29) Preset Int.: Set all the preset data back to the factory defaults.

- 1) To clear the PRESET data, push the **PARAMETERS** button. "Preset Int?" flashes on the character display.
- 2) Push the **PARAMETERS** button again. "Preset Initial!" is displayed on the character display while data clearing.
- 3) Once clearing is completed, "Complete!" is displayed.

Compatible Files

The files that can be played using an external USB memory device are as shown below.

NOTE

- Depending on the type of MP3 encoding software, with some files noise may be generated or it may not be possible to play the file.
- Recordings you make are for your personal use and should not be used in ways infringing upon the copyright holder as per copyright laws.
- With MP3 files, the files cannot be played if the pitch is 24% or greater.

MP3/WAV FORMAT

MP3 Format	MPEG-1	Audio Layer-3 40-320kbps f/s 44.1kHz, STEREO
	ID-3 Tag	V1.0, V1.1, V2.2, V2.3, V2.4 (ASCII + ISO8859-1(West European))
	Encoding	C.B.R, V.B.R.
WAV Format	PCM	16bit f/s 44.1kHz
	Metadata Tag	Supported by Denon DJ Music Manager, Audio Grabber, Dragon Tagger



.m3u and .xml playlists are supported only through DENON DJ Music Manager.

Specifications

GENERAL

Type:	CD/USB media player and controller
Media type:	Standard compact disc (12 cm), CD-TEXT, CD-R, CD-RW ※ Finalized CD-R and CD-RW discs can be played on the DN-S1200. Depending on the recording conditions and other factors, however, it may not be possible to play some CD-R and CD-RW discs. MP3 files recorded on CD-R and CD-RW discs cannot be played.
Dimensions:	USB mass storage device (USB HDD USB flash drive) 215 (W) x 87.4 (H) x 232 (D) mm (up to the panel surface)
Weight:	3.2 kg
Power supply:	U.S.A., Canada models: AC 120 V ±10 %, 60 Hz European models: AC 230 V ±10 %, 50 Hz Japan model: AC 100 V ±10 %, 50/60 Hz
Power consumption:	10 W
Environmental conditions	
Operational temperature:	5 ~ 35 %
Operational humidity:	25 ~ 85 %
Storage temperature:	-20 ~ 60 °C

AUDIO SECTION

Quantization:	16-bit linear per channel
Sampling frequency:	44.1 kHz at normal pitch
Total harmonic distortion:	0.05 % or less (1 kHz)
Signal to noise ratio:	100 dB or more (A-weighted)
Channel separation:	100 dB or more
Frequency response:	20 ~ 20 kHz, ±0.5 dB
Analog output	
Output level:	2.0 V r.m.s.
Digital output	
Signal format:	IEC958-Type2
Output level:	0.5 Vp-p 75 Ω

FUNCTIONS

Instant start:	Within 20 msec.
Variable pitch:	±4 % (0.02 %pitch) ±10 % (0.05 %pitch) ±16 % (0.05 %pitch) ±24 % (0.1 %pitch) ±50 % (0.5 %pitch) ±100 % (1.0 %pitch)
Pitch bend:	Pitch range ±4 % ~ ±24 % : ±32 % Pitch range ±50 % ~ ±100 % : -99 % ~ +100 %
Search precision:	1/75 sec. (1 subcode frame)
Max. no. files:	50,000 files per device
Max. no. playlists:	1,000 files per device
Max. no. playlist files:	99 per device
Max. no. folders:	5,000 per device
Max. no. folder files:	1,000 per folder
Max. no. music titles:	50,000 per device
Max. no. artist names:	20,000 per device
Max. no. album titles:	10,000 per device
Max. no. genres:	500 per device

※ Specifications and design are subject to change without notice for purpose of improvement.

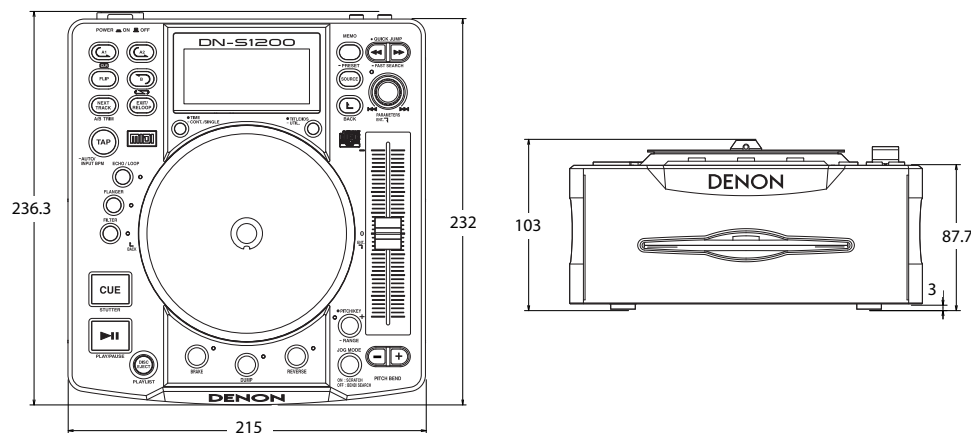

Unit: mm

D&M Holdings Inc.
PROFESSIONAL BUSINESS COMPANY

TOKYO, JAPAN
<http://www.dm-pro.jp>

Professional Business Company, D&M Holdings Inc.