

English



BASIC

Digi Dim-12

12 CH. DIGITAL MODULE DIMMER

USER'S MANUAL

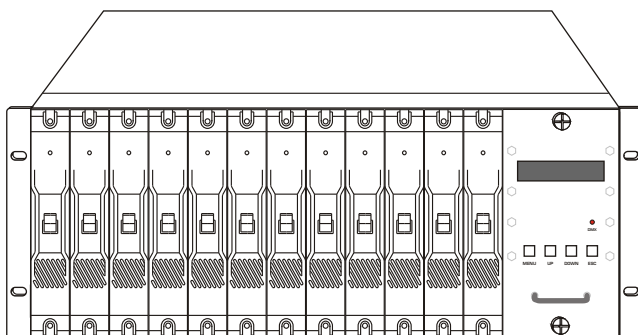

Please read before use

Contents

Features 1

General Instructions 2

1. Overview 3

1.1 Front View 3

1.2 Rear View 5

2. Operation Guide 7

2.1 Display and standby mode 7

2.2 Set-up Menus 8

2.2.1 DMX fail 8

2.2.2 Phase Correction 9

2.2.3 DMX Address 10

2.2.4 Preheat 11

2.2.5 Curve 13

2.2.6 Preset 14

Technical Specifications 16



Digi DM-12

Improvement and changes to specifications, design and this manual, may be made at any time without prior notice.

All Rights Reserved.

Features

Thank you for your purchase. This product features include:

- 12 DMX channel
- Individual DMX address / Block address
- Individual channel dimmer / Master dimmer
- Each channel can be programmed with the DMX address, and the preheat of the lamps(0-50%).
- Any of 12 chase programs can be recalled as required, chase speed is adjustable
- Chase programs 1-12, DMX Hold, Analogue can be selectable in the event DMX fails.
- Phase correction leads to linear dimming(0-100%).
- Control curve can be selectable from Linear/Switch/Square.
- Analogue input works even without any adjustment
- The short circuit protection for each channel with the use of 10A circuit breaker
- LCD Display
- Power failure memory

General Instructions

Please read through this operating instructions before installing or using your new product. After you have finished reading the instructions, put them away in a safe place for future reference.



WARNING!

This product must be earthed.

To prevent fire or shock hazard, do not expose this product under high temperature or moisture area.

Do not make any inflammable liquids, water or metal objects enter the unit.

No user serviceable parts inside, do not attempt repairs. Should you product fail, contact your local dealer.



CAUTION!

This product is intended for indoor use only.

Provide occasional ventilation during use.

Disconnect the power when not use for extended period.

Do not use the unit in places subject to excessive humidity, vibration or bumps.

Do not dismantle or modify the unit.

1. Overview

1.1 Front View

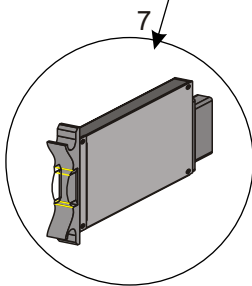
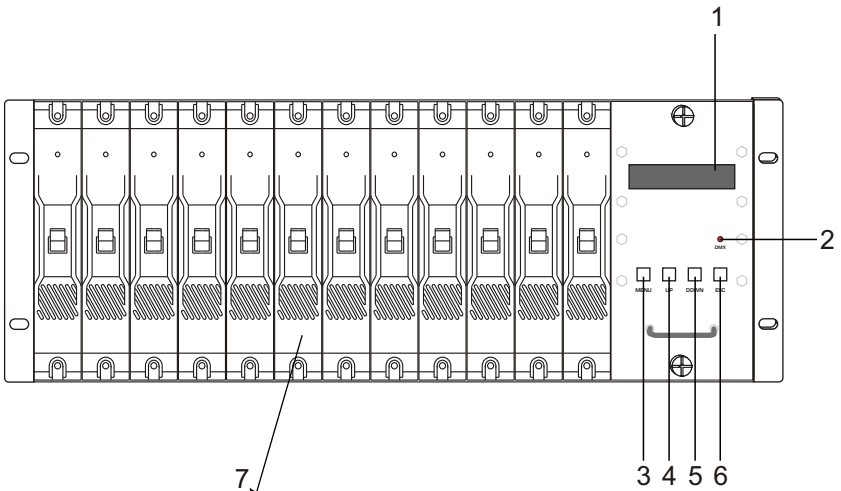

Channel dimmer module

1. Overview

1.1 Front View

1. 2x16 LCD Display

Shows the current activities or adjustments of menus.

2. DMX LED

This LED blinks when DMX signal is present.

3. MENU Button

This button is used to access set-up menus.

4. UP Button

Tap this button to scroll through menus or to increase values .

5. DOWN Button

Tap this button to scroll through menus or to decrease values .

6. ESC Button

Tap this button to go back last menu level or to leave menu system.

7. Channel Dimmer Module(x12)

The channel dimmer module is incorporated with a 10A circuit breaker and SCRs with 1000A peak current capacity. The removable, plug & play module enables easy and flexible setup of 12 channel module.

1. Overview

1.2 Rear View

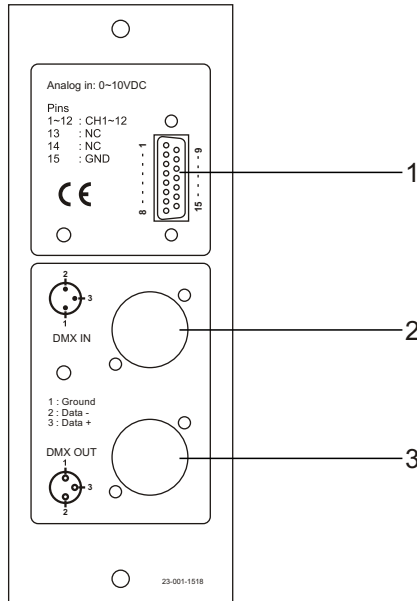

1. *Analogue Input*

DC 0-10V

2. *DMX Input*

This jack is used to receive an incoming DMX signal..

3. *DMX Output*

This jack is used to send DMX signal to next DMX device or link to another unit.

1. Overview

1.3 Mains power & Output Termination

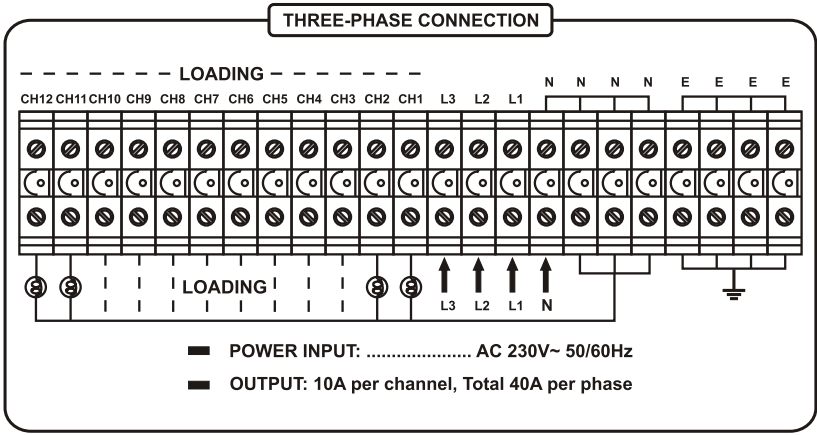
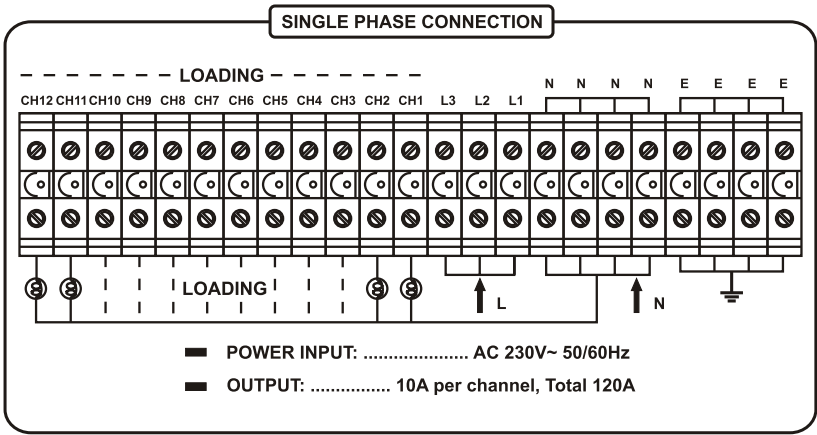

2. Operation Guide

2.1 Display and standby mode

Power on this unit, the LCD shows the revision of software immediately, then enter standby mode automatically, the LCD shows the dimming level of each channel as below. The first row indicates the dimming level, and the second row indicates the channel(1 stands for channel 1, 2 stands for channel 2, and so on. A, B and C stand for channel 10, 11 and 12.).



2.2 Set-up Menus

In standby mode, tap MENU button to enter set-up menus .

There are 6 menus: DMX Fail, Phase Correction, DMX Address, Preheat, curve and Preset , you can use UP/DOWN button to scroll through the menus.

Tap ESC button to leave set-up menus system.

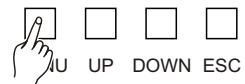
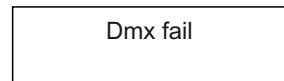

2.2.1 DMX Fail

1. Tap UP/DOWN button to scroll to DMX Fail menu.

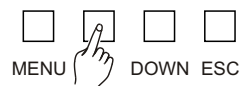
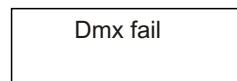

2. Operation Guide

2.2.1 DMX Fail

2. Tap MENU button again to enter sub-menu system. You can use UP/DOWN button to select Hold/Analog/Prog. 1-12.

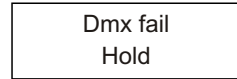

- [Hold]: Last received DMX signal is held.
- [Analog]: The analogue input(0-10v) is activated.
- [Prog. 1-12]: Starts internal programs 1-12.

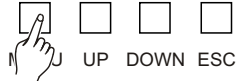

3. If you select Hold or Analog, you can tap ESC button to exit.

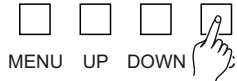
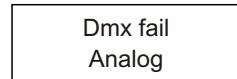

4. If you select Prog. 1-12, tap ESC button, speed menu will be activated.

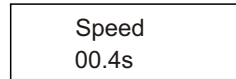

You can select the chasing speed from 0.1 to 20 seconds using UP/DOWN button.

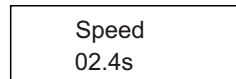
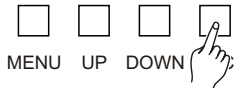

After you've finished your setting, tap ESC button to exit.

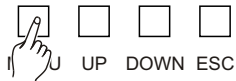

2. Operation Guide

2.2.2 Phase Correction

1. Tap UP/DOWN button to scroll to Phase Correction menu.

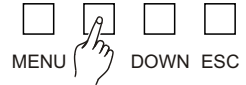
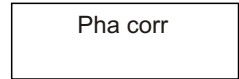

2. Tap MENU button to enter sub-menu system. You can use UP/DOWN button to select Yes/No.

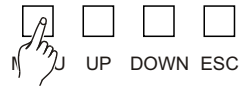
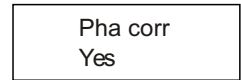

[Yes]: Linear dimming is activated.

[No]: Non-linear dimming is activated.

3. Tap ESC button to exit.

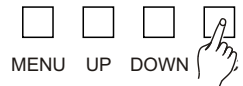
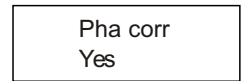

2.2.3 DMX Address

1. Tap UP/DOWN button to scroll to DMX Address menu.

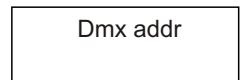

2. Operation Guide

2.2.3 DMX Address

2. Tap MENU button to enter sub-menu system. You can use UP/DOWN button to select Block/Single.

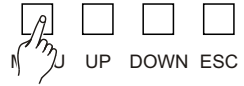
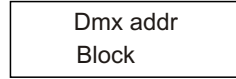

[Block]: Complete dimmer(6 channels) has only one start address.

[Single]: The DMX address of each channel is selectable, several channels can select the same DMX addresses.

3. Tap UP/DOWN button to scroll to Block/Single menu, and tap MENU to enter Block/Single mode.

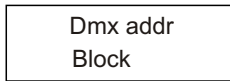

+

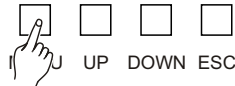
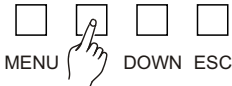
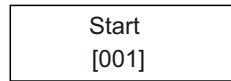

4. In Block mode, you can use UP/DOWN button to select the start address from [001-512].

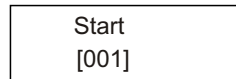

2. Operation Guide

2.2.3 DMX Address

5. In Single mode, tap MENU to change between the channel and its address.

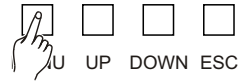
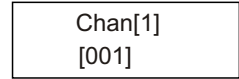

6. When channel is activated, tap UP/DOWN button to select from [1-12]; when address is activated, tap UP/DOWN button to select from [001-512].

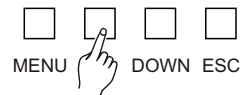
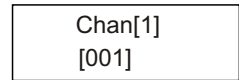

7. Tap ESC button to exit.

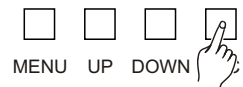
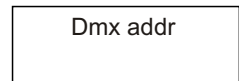

2.2.4 Preheat

1. Tap UP/DOWN button to scroll to Preheat menu.

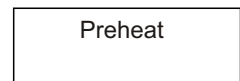

2. Operation Guide

2.2.4 Preheat

2. Tap MENU button to enter sub-menu system.

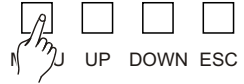
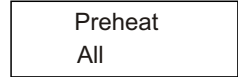

3. Tap UP/DOWN button to select between All/Single mode, and tap MENU to enter All/Single mode.

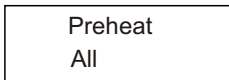

+

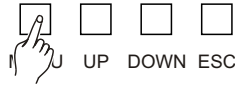
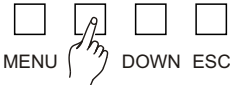
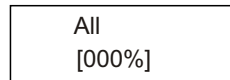

4. In All mode, tap UP/DOWN to select preheat value of all channels between 000%-050%.

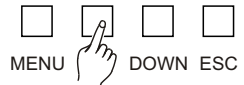
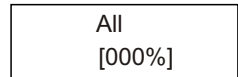

5. In Single mode, tap MENU to select between channel and preheat value.

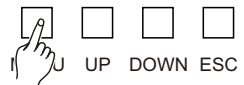
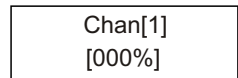

2. Operation Guide

2.2.4 Preheat

- When channel is activated, tap UP/DOWN button to select from [1-12]; when preheat is activated, tap UP/DOWN button to select from [000%-050%].

Chan[1]
[050%]

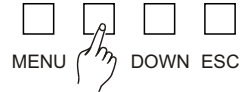

- Tap ESC button to exit.

Preheat

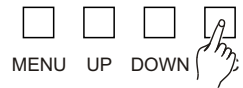

2.2.5 Curve

- Tap UP/DOWN button to scroll to Curve menu.

Curve

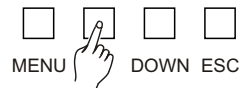

- Tap MENU button to enter sub-menu system.

Curve
Linear

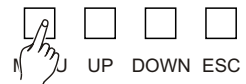

2. Operation Guide

2.2.5 Curve

3. Tap UP/DOWN button to select from Linear/Switch/Square.

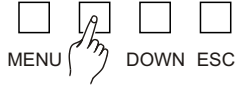
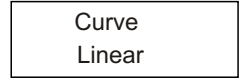

4. Tap ESC button to exit.

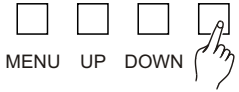
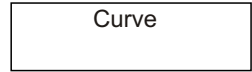

5. You can tap ESC button to return to Beginning Menu.

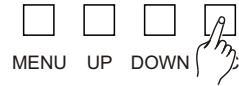

2.2.6 Preset

This menu allows you to control the dimmer of all channels or individual channel.

1. Tap UP/DOWN button to scroll to Preset menu.

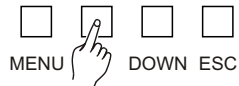
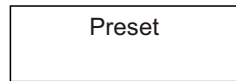

2. Operation Guide

2.2.6 Preset

2. Tap MENU button to enter sub-menu system.

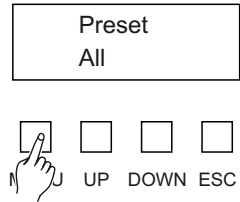

3. Tap UP/DOWN button to select between All/Single mode, and tap MENU to enter All/Single mode.

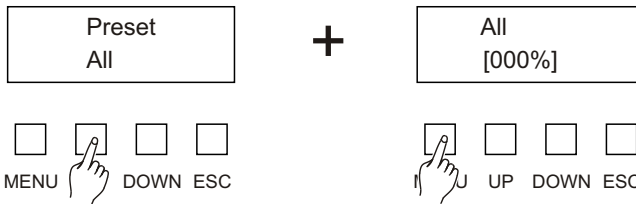

4. In All mode, tap UP/DOWN to adjust the master dimming level from 000%-100%.

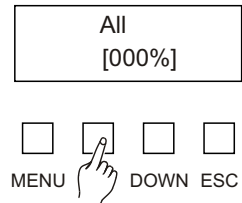

5. In Single mode, tap MENU to change between the channel and its dimming level.

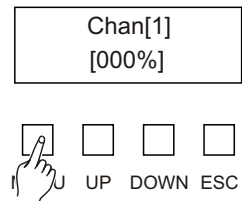

2. Operation Guide

2.2.6 Preset

6. When channel is activated, tap UP/DOWN button to select from [1-12]; when dimming level is activated, tap UP/DOWN button to select from [00%-100%].

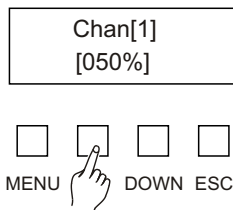

7. Tap ESC button to exit.

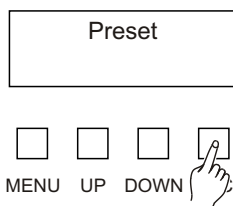

Technical Specifications

| | |
|-----------------------------------|------------------------------|
| Power Input | AC 230V~50-60Hz |
| Channel Output(Single phase)..... | 10A/CH., Total 120A |
| Channel Output(Three phases)..... | 10A/CH., 3x40A |
| DMX Output | 3 pin female XLR socket |
| DMX Input | 3 pin male XLR socket |
| Analogue Input | 0-10V, 15-pin sub DIN socket |
| Dimensions | 482x390x160mm |
| Weight(appro.) | 20.8 Kg |



Printed in PR China