

Using LCRplus

The **ML5000** LCRplus system extends signal imaging beyond conventional LR and LCR panning by allowing full 3 speaker balance and positioning from each channel and group. This satisfies the standard requirements of mono, stereo and conventional LCR speaker systems as well as providing a unique extended capability.

The MAIN MIX. This comprises 3 outputs: L (left), R (right) and C (centre). How you use these depends on the type of sound system you are running. For example, you may use all for a 3 cluster LCR system, just L and R for a conventional stereo system, or C only for a mono system.

PAN and BLEND. These are the two imaging controls that let you position the sound anywhere in the three output mix. For example, it could be balanced in all three outputs, somewhere between any two, or routed to just one. The controls have a smooth response with 3dB centre attenuation to ensure that the power is distributed evenly between the speakers as you move the signal around.

MONO PA. To control a mono sound system using a single master fader, set BLEND fully clockwise to route all the channel signal to the C output. The LR outputs are not used and PAN has no effect.

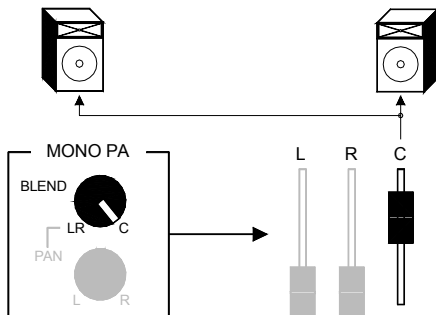

STEREO PA. To control a stereo sound system, set BLEND fully anticlockwise to route the signal to LR only. Use PAN to position the sound between the speakers. The C output is not used.

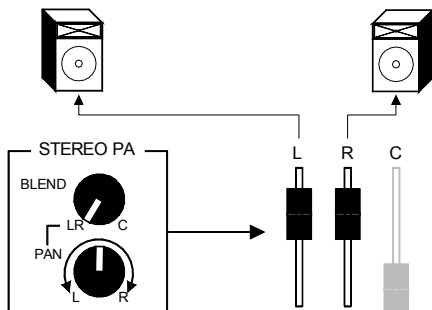

STEREO + CENTRE FILL. A centre fill speaker is used to reinforce the sound to the first few rows of the audience when the L and R speakers are positioned far apart. Start with BLEND fully anticlockwise to set up the main LR mix. Then gradually rotate BLEND clockwise to raise the signal in the fill speaker as required. It should not be necessary to adjust beyond the centre position at which point equal signal is fed to all 3 outputs. Beyond centre the LR signal would drop significantly. Having LCRplus available on every channel and group means that you can choose which signals are reinforced, for example the back stage mics rather than the front floats which would feed back if routed to the fill.

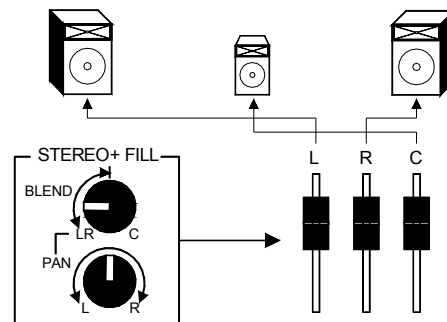

LCR PA. LCR systems are increasingly popular in large installed or touring systems. They comprise three main speaker stacks, left, centre and right to provide better coverage of a large audience. In some situations C is used only for sounds such as vocals to lift them out of the mix making them more intelligible, leaving backing instruments in the LR speakers. In other situations individual sounds are panned between the speakers according to source position.

Adjust both BLEND and PAN to position each sound exactly where you want it whether in one speaker, between two, or blended across all three. Use BLEND to balance between the LR and C speakers. Use PAN to adjust the balance between the L and R speakers. PAN does not affect the level of the C output.

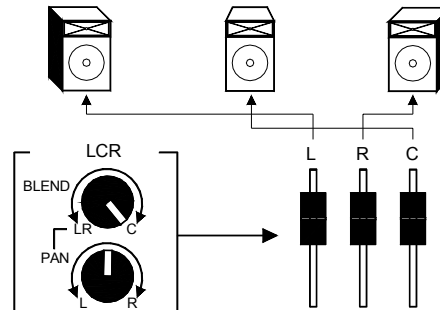

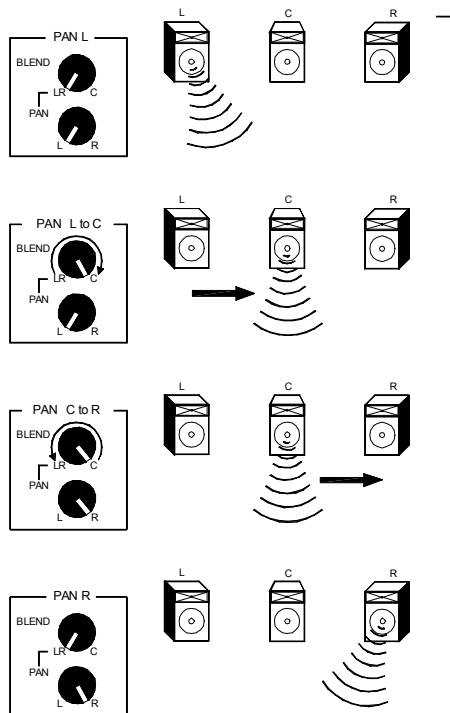

Positioning the Sound. Use the PAN and BLEND controls to position the sound within the LCR image. It is possible to dynamically move the sound using the two controls together but this is not a common requirement in real world systems. For example, dynamically panning an actor as he moves across a theatre stage may be uncomfortable for the front row listeners who hears the voice move from say the left speaker upwards to the hung centre speaker, and then back down to the right rather than evenly across the stage. Static positioning is more common in the theatre situation where the ear adjusts to and accepts the source of the sound.

PAN L. To position the sound at the left speaker only set PAN fully left and BLEND to LR.

PAN L to C. To position the sound between the left and centre speaker set PAN fully left and adjust BLEND clockwise from LR to C.

PAN C to R. To position the sound between the centre and right speaker set PAN fully right and adjust BLEND anticlockwise from C back to LR.

PAN R. To position the sound at the right speaker only set PAN fully right and BLEND to LR.

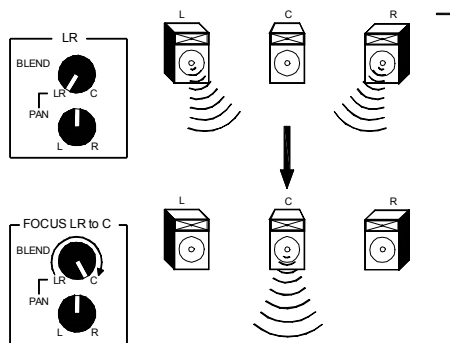

Focussing the Sound. Typically, a large music venue or festival may use an LCR system with vocals and key sounds such as kick and bass fed to the main centre cluster and backing instruments fed to the LR stacks. This helps the clarity and intelligibility of these sounds.

Use BLEND to position each sound in the LR or C speakers. You can dynamically bring a sound forward by panning it from LR to C. For example, use this to improve the focus of a backing instrument such as guitar for the duration of a lead solo. Pan it back from C to LR again after the solo.

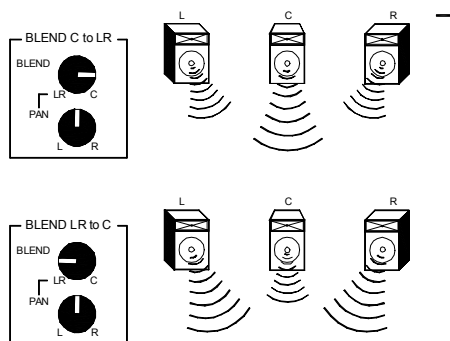

Blending the Sound between Speakers. In non-ideal situations where the three speakers do not cover all the audience evenly, a small portion of centre cluster lead sounds such as vocals can be blended into the LR stacks so improving coverage. Similarly, LR sounds can be blended into the centre cluster.

Using the two controls you can adjust the balance smoothly listening to the results and being able to make small changes without the big jumps in volume associated with switched routing.

While you could use the matrix to balance groups of sounds between the speakers, LCRplus lets you balance the image independently for each sound.