

RIGHT VIEW

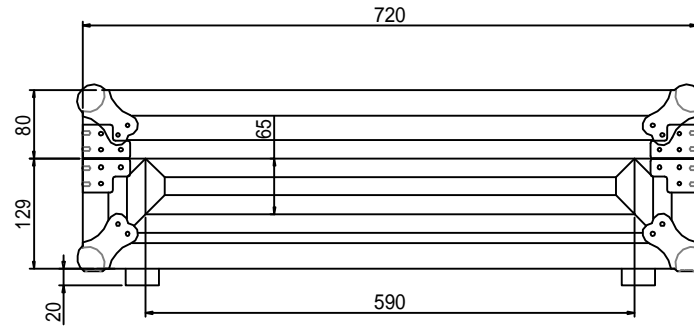

FRONT VIEW

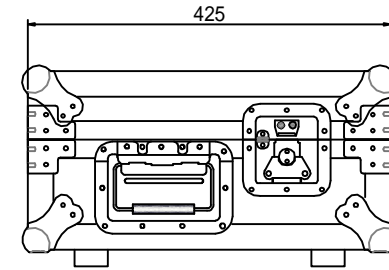

LEFT VIEW

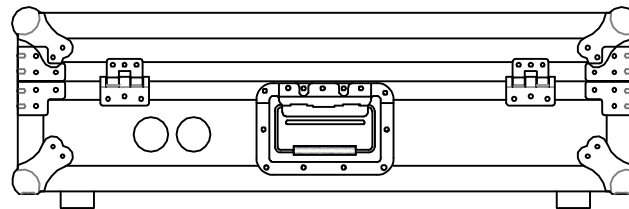

BACK VIEW

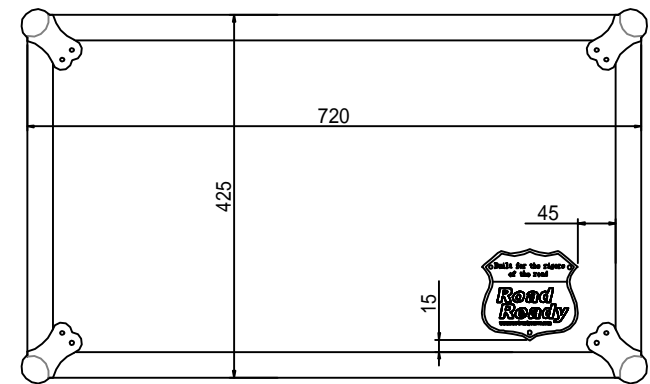

TOP VIEW

# RRDJCONTROL

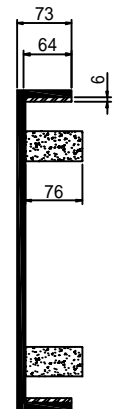
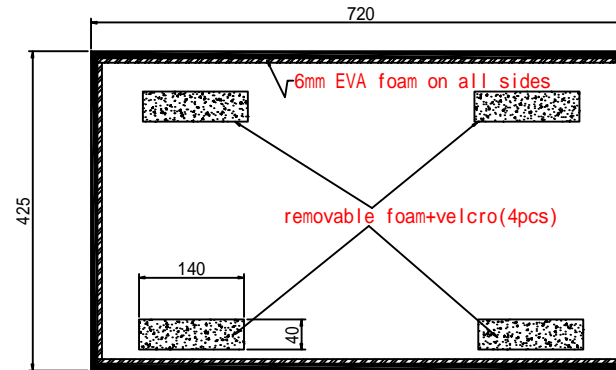
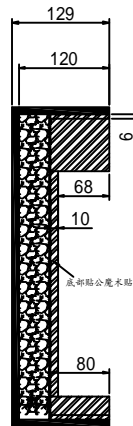
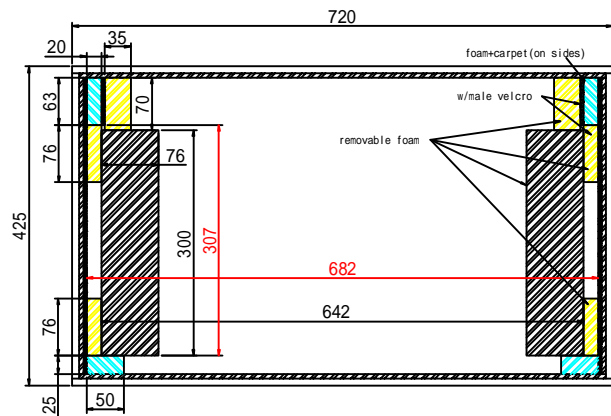
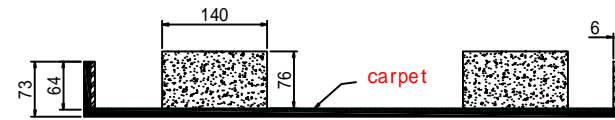
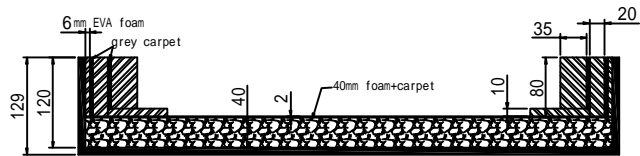

TOP VIEW OF COVER

TOP VIEW OF BASE